

Princeton Plasma Physics Laboratory Highlights for Fiscal Year 2006

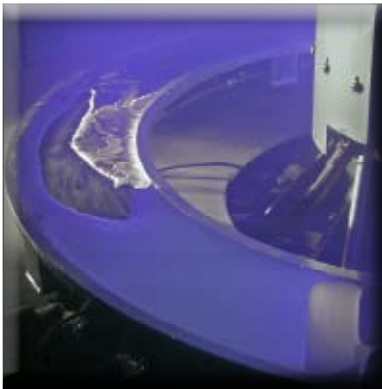

**Office of
Science**
U.S. DEPARTMENT OF ENERGY



PPPL
PRINCETON PLASMA
PHYSICS LABORATORY

About PPPL

The Princeton Plasma Physics Laboratory (PPPL) is dedicated to developing the scientific and technological knowledge base for fusion energy as a safe, economical, and environmentally attractive energy source for the world's long-term energy requirements. Princeton University manages PPPL under contract with the U.S. Department of Energy. The fiscal year 2006 budget was approximately \$83 million. The number of full-time regular employees at the end of the fiscal year was 397, not including approximately 35 subcontractors and limited-duration employees, 37 graduate students, and visiting research staff. The Laboratory is sited on 88 acres of Princeton University's James Forrestal Campus, about four miles from the main campus.

Through its efforts to build and operate magnetic fusion devices, PPPL has gained extensive capabilities in a host of disciplines including advanced computational simulations, vacuum technology, mechanics, materials science, electronics, computer technology, and high-voltage power systems.

PPPL scientists and engineers are applying knowledge gained in fusion research to other theoretical and experimental areas including the development of plasma thrusters and propagation of intense beams of ions. The Laboratory's Office of Technology Transfer assists industry, other universities, and state and local government in transferring these technologies to the commercial sector.

The Laboratory's graduate education and science education programs provide educational opportunities for students and teachers from elementary school through postgraduate studies.

On The Cover

A collage of scenes depicting activities during fiscal year 2006 is shown. Photos are described left to right. Top row: internal view of the NSTX vacuum chamber, activities in PPPL's newly completed Plasma Science Education Laboratory, and heated copper shell inside the former CDX-U vacuum vessel. Middle row: fabrication of an NCSX modular coil, liquid lithium limiter tray during argon glow discharge operation on the former CDX-U, and one of three NCSX vacuum vessel field-period sectors with ports installed for vacuum testing. Bottom row: PPPL physicist Robert Budny discusses fusion at PPPL's exhibit at the 2006 Princeton Communiiversity, a sample end of the ITER toroidal-field conductor in conduit superconducting cables with one of six bundles unbraided (the central perforated tube provides cryogenic cooling), and Plasma Academy Workshop students determine which solar-powered car can climb the steepest hill.

Mission

The U.S. Department of Energy's Princeton Plasma Physics Laboratory is a Collaborative National Center for plasma and fusion science. Its primary mission is to make the scientific discoveries and develop the key innovations that will lead to an attractive new energy source.

Associated missions include conducting world-leading research along the broad frontier of plasma science and technology, and providing the highest quality of scientific education.

Vision

Deepening the understanding of plasmas and creating key innovations to make fusion power a practical reality.

Advantages of Fusion Energy

- Worldwide availability of inexhaustible low-cost fuel.
- No chemical combustion products and therefore no contribution to acid rain or global warming.
- No runaway reaction or meltdown possible.
- Materials and by-products unsuitable for weapons production.
- Radiological hazards thousands of times less than from fission.
- Compact, steady energy source without need for large-area land use, large-scale energy storage, very long-distance transmission, or local carbon dioxide sequestration.
- Fusion complements other nearer-term energy technologies.

To go to a section, place your cursor over the section title or the page number and when the hand with the pointing figure appears click the mouse.

Table of Contents

From the Director	vii
National Spherical Torus Experiment	1
National Compact Stellarator Experiment	15
ITER	21
Theory and Advanced Simulations	27
Computational Plasma Physics	37
Space Plasma Physics	45
Off-site Research	49
DIII-D Collaborations	49
Alcator C-Mod Collaborations	51
International Collaborations	53
Lithium Tokamak Experiment	57
Magnetic Reconnection Experiment	61
Plasma Science and Technology	67
Magnetorotational Instability Experiment	67
Liquid Metal Experiment	68
Magnetic Nozzle Experiment	69
Princeton Field-reversed Configuration Experiment	70
Hall Thruster Experiment	70
Nonneutral Plasmas, High-intensity Accelerators, and High Energy Density Physics	73
Diagnostic Development	78
Engineering and Technical Infrastructure	81
Environment, Safety, and Health	87
Applications Research and Technology Transfer	91
Patents and Invention Disclosures	95
Graduate Education	97
Science Education	101
Awards and Honors	107
The Year in Pictures	109
Financial Summary	113
PPPL Organization and Staffing	115
PPPL Advisory Council	117
Publications	119
Abbreviations, Acronyms, and Symbols	153

From the Director

Fiscal year 2006 (October 2005 – September 2006) brought exciting new capabilities and results on the National Spherical Torus Experiment (NSTX), very high quality component construction on the National Compact Stellarator Experiment (NCSX), the signing of the ITER Agreement at the ministerial level, strong contributions from theory and advanced computing, excellent results from the Princeton Plasma Physics Laboratory's (PPPL) collaborations on Doublet III-D (DIII-D), Alcator C-Mod and the Joint European Torus (JET), as well as a new deeper layer of understanding of the basic physics of magnetic reconnection. We also contributed fundamental understanding of how black holes interact with the plasma that swirls around them and how intense ion beams can be focused. We continued in the development of micro-aviation vehicles and tools to detect rogue radioactive materials for homeland security. This was an exciting year at PPPL.

This year NSTX, with its improved poloidal-field coils, produced more strongly shaped plasmas, with longer pulses, which achieved values of beta and of bootstrap current fraction representative of an Spherical Torus-based Component Test Facility. Key diagnostic systems were upgraded to higher resolution, and entirely new diagnostic tools were brought on line. The result was the ability to measure clearly, for the first time in the world, the effects of low- n instabilities on fast-ion current drive, and to perform highly localized measurements of electron-scale-length instabilities. Excellent results were achieved on feedback stabilization of resistive wall modes, while varying rotation speed using non-resonant perturbations. Clear evidence was provided that multiple mode overlap leads to enhanced fast-ion redistribution during Toroidicity-induced Alfvén Eigenmode (TAE) bursts. Nonlinear three-wave coupling of modes was clearly demonstrated as well. Confinement scaling in Spherical Torus plasmas was convincingly measured, demonstrating a stronger toroidal-field variation than in other devices. Due to the excellent diagnostics on NSTX these experiments clarified that the toroidal-field scaling was mostly in the electron channel, and the plasma current scaling in the ion channel. Enticingly, lithium wall coating demonstrated a $\sim 20\%$ improvement in confinement.

Construction on NCSX proceeded well this year. Delivery of the modular coil winding forms from industry began and, after some initial difficulties, accelerated to the needed pace. Winding of the complex modular coils



Robert J. Goldston

themselves was begun and the required very high level of accuracy was achieved. As more experience was gained with the procedure, it began to move more rapidly, and by year's end four of the eighteen coils were completed. The manufacture of all three sectors of the vacuum vessel for NCSX was completed this year as well.

PPPL's role as a partner in the U.S. Contributions to ITER Project will be to lead the U.S. diagnostics program and the development of ITER's steady-state electrical power network. The diagnostics task includes both the design and manufacture of scientific instruments, and also the development of the complex "port plugs" which provide the interface between scientific measurement tools and the fusion nuclear environment of ITER. PPPL will also support the magnet work and ion cyclotron transmission lines for ITER. PPPL is strongly engaged in scientific preparations for ITER through the International Tokamak Physics Activity, the U.S. Burning Plasma Organization, and ITER Design Review Working Groups.

Access to the most powerful nonclassified computers has allowed substantial advances in plasma theory this year, supporting, for example, global-scale turbulence calculations showing that ion thermal transport in NSTX should be relatively immune to the ion-temperature-gradient modes that are believed to cause much ion thermal transport in conventional tokamaks. On the other hand, in more conventional configurations this turbulence is not only important in transport, but it can spread from unstable to stable regions, causing transport in regions

that are not predicted, in local models, to have turbulence. Advanced nonlinear calculations of beam-driven modes in NSTX show the experimentally observed chirping down in frequency and the evolution of mode structure as the fast-ion distribution evolves self-consistently under the impact of the mode. Continuum damping of Toroidicity-induced Alfvén Eigenmode modes was calculated accurately, and found to agree with experiments on C-Mod, resolving a long-standing discrepancy between theory and experiment. The Theory Department has also supported the Compact Stellarator Program by providing guidance for the placement of magnetic detection coils for equilibrium reconstruction, and finding operating modes with even higher symmetry than those planned during the machine design. The Computational Plasma Physics Group has helped implement PPPL's codes on the fastest computers and both sped up and increased the availability of PPPL's TRANSP transport analysis code, with the result that more than 2,500 production runs were performed for the world research community this year on PPPL's cluster.

The Off-site Research Department continued to perform leading-edge research on major devices not available at PPPL. By working on both DIII-D and JET, PPPL scientists demonstrated that Alfvén eigenmodes can be driven unstable even by thermal ion gradients, so these modes are far more prevalent than previously understood. To do this required the application of advanced internal diagnostics, as begun on the Tokamak Fusion Test Reactor (TFTR), to measure these modes. On C-Mod, PPPL's major contributions to the lower-hybrid wave launcher began to bear fruit, as current drive was convincingly demonstrated on C-Mod this year.

The Plasma Science and Technology Department scored some major successes this year. The Magnetic Reconnection Experiment measured, for the first time in a laboratory plasma, the fine-scale electron diffusion region that is created by the Hall effect, and where

the final reconnection process takes place. Furthermore intense magnetic fluctuations are found localized in the reconnection zone, correlating in time and space with reconnection events. While the results are not fully in place, it appears that the long-standing scientific controversy over whether anomalous reconnection is caused by the Hall effect or by turbulent resistivity may be resolved by the proverbial "you are both right." Another very exciting piece of basic physics this year was uncovered using a rapidly rotating pair of coaxial cylinders that produced sheared flow analogous to the Keplerian flow of plasma orbiting a black hole or a planet-forming star. It was shown that even at very high speeds there is no instability in the absence of magnetic field effects. This has strong implications for theories of star and planet formation. Another very exciting result was provided closer to the area of fusion energy. One of the main challenges for fusion using heavy ions to heat and compress fuel capsules, is to make a beam of ions that is highly localized both parallel to and transverse to its direction of motion. Numerical calculations that this could be achieved using a background plasma to neutralize the space-charge of the ion beam were confirmed using a long intense plasma source developed by PPPL and applied at the Lawrence Berkeley National Laboratory.

Applications research activities have been successful this year as well, with PPPL contributing practical tiny micro-aviation vehicle prototypes to the Naval Research Laboratory's Micro Air Vehicle Program, and with our Miniature Integrated Nuclear Detection System being deployed for field testing.

In sum, FY2006 was an exciting year of scientific progress on all fronts. With NSTX producing key results, NCSX construction demonstrating high quality, signing of the ITER agreement at the ministerial level, advances in theory and in Off-site research, we continue to bring fusion energy closer to practical reality.

National Spherical Torus Experiment



National Spherical Torus Experiment

The National Spherical Torus Experiment (NSTX) is designed to study toroidal plasma confinement physics in a low aspect ratio tokamak configuration. It produces plasmas with toroidal aspect ratio, i.e., the ratio of the major to the minor radii of the toroidal plasma, as low as 1.25, which can be heated by up to 6 MW of radio-frequency (rf) wave power and up to 7 MW of deuterium neutral-beam injection (NBI). Conducting plates surround the plasma on the large major radius side to provide stabilization against external kink and ballooning modes. The NSTX has achieved plasma currents up to 1.5 MA and has produced plasma discharges with very high values (up to ~40%) of the plasma toroidal beta, a measure of the efficiency of external magnetic field usage. As a result of this unique combination of capabilities,

NSTX accesses ITER-relevant regimes in the area of wave-particle interactions, which are not accessible elsewhere. The low aspect ratio complements and extends conventional tokamak experiments in investigating key scientific issues of toroidal fusion plasmas for developing an attractive Component Test Facility (CTF) and, ultimately, a demonstration fusion power plant.

In FY06, the NSTX completed 12.6 weeks of plasma operation, meeting its milestone of 11 weeks set by the U.S. Department of Energy (DOE). The plasma operation provided data for 30 different experiments.

Several new machine capabilities were introduced this year. The project met a high-level DOE milestone for the year by installing and operating an evaporator to coat the plasma-facing components with lithium. Software was developed and implemented in the real-time

control system that allowed feedback control of external field-error correction coils capable of producing a radial magnetic field to improve plasma stability limits. The operating voltage of the coaxial helicity injection system was increased from 1.5 to 1.7 kV. This year experiments benefited from routine operation at a toroidal field of up to 0.55 T.

The plasma diagnostics on NSTX have also been improved this year. A tangentially viewing microwave scattering system was installed and commissioned to measure density fluctuations with radial wavenumber in the range $k_r = 2\text{--}24\text{ cm}^{-1}$, corresponding to fluctuations on the scale of the electron gyroradius in typical NSTX conditions. The motional Stark effect system for measuring the q -profile was upgraded to 12 spatial channels. The multipulse Thomson scattering system was extended from 20 to 30 channels to improve its resolution of the edge region of the plasma. The far infrared tangential interferometer polarimeter (FIReTIP) was increased from four to six channels. A new “multi-color” (i.e., multiple energy band) ultra-soft X-ray detector array was installed for fast measurement of the radial electron temperature profile. A dual-band radiometer was installed and used for detecting electron Bernstein wave (EBW) emission from the plasma. Finally, a third infrared camera was installed for studying divertor heat loads.

Plasma Performance Extension

The ability to make plasmas with high elongation, κ , has been an important goal of NSTX. In conjunction with high triangularity, δ , it increases the shaping factor, defined as $S \equiv q_{95}(I_p/aB_T)$ where q_{95} is the magnetohydrodynamic “safety factor” at the surface containing 95% of the poloidal flux, I_p is the plasma current (in MA), a the minor radius (in m) and B_T the toroidal magnetic field (in T) at the plasma center. A high shaping factor is desirable for attaining high fractions of the bootstrap current needed for sustained operation.

As shown in Figure 1, for a discharge produced in 2006 with $\kappa \approx 2.4$, $\delta \approx 0.7$, and $S = 32\text{ MA/m}\cdot\text{T}$, the calculated noninductive current fraction is $\sim 50\%$. Experiments in 2006 have led to the simultaneous achievement of record transient values of the elongation, $\kappa = 3$, and shaping parameter, $S = 40\text{ MA/m}\cdot\text{T}$. For this discharge, $\kappa > 2.8$ for 40 ms which is $\sim 3\tau_{\text{vert}}$, where τ_{vert} is the growth time for the vertical plasma instability. A flux plot of the record elongation equilibrium is shown in Figure 2. The predicted improvement in performance as a function of increased plasma shaping is confirmed in Figure 3. Each point in this figure represents the value of toroidal beta, β_T , time averaged over the plasma current flattop. The data are sorted by year in the upper frame

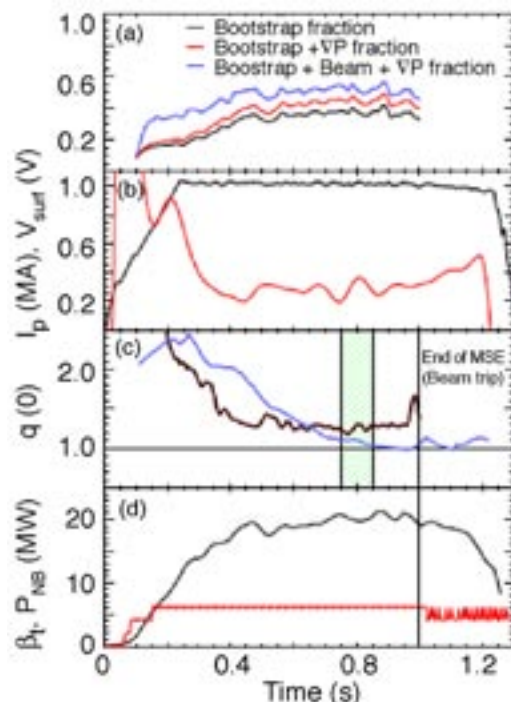

Figure 1. The time history of plasma discharge 120001 showing (a) the components of noninductive current as indicated in the plot legend, (b) the plasma current (black) and the surface voltage (red), (c) the reconstructed $q(0)$ (black) and $q(0)$ as determined by a TRANSP code magnetic diffusion calculation (blue), and (d) toroidal beta, β_T , (black) and neutral-beam power (red). The profiles in Figure 4 are calculated over time interval indicated in green.

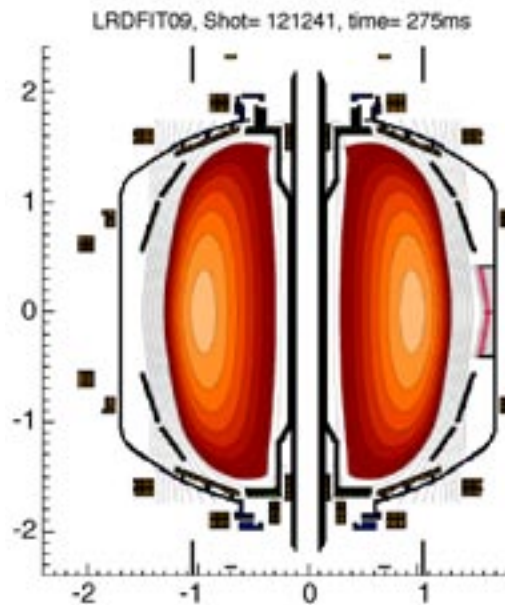

Figure 2. Flux plot of the record elongation plasma equilibrium.

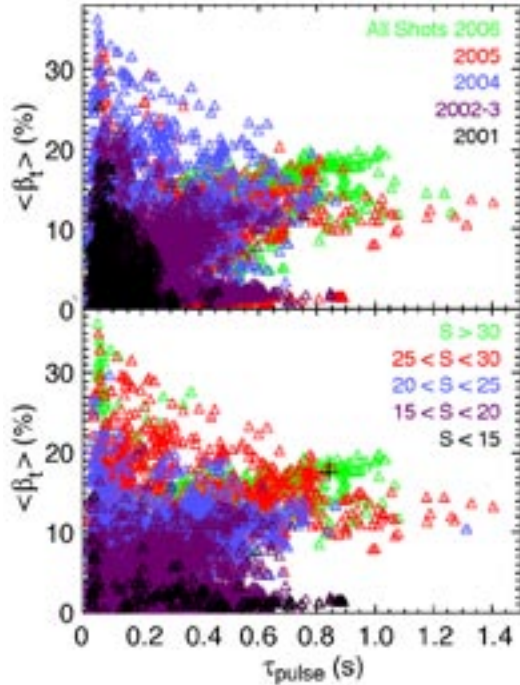

Figure 3. Toroidal beta, β_t , averaged over the plasma current flattop for each plasma discharge in the NSTX database plotted versus the current flattop time. The data are sorted by year in the upper frame, and by shape factor S in the lower frame.

and by shape factor S in the lower. As can be seen from the figure, the increasing shape factor on NSTX has led to an increase in both the maximum pulse length and the average value of toroidal beta.

An important topic in spherical torus (ST) research is to develop predictive capability for the current profile in advanced scenarios where much of the current will be sustained noninductively and there will be a close coupling to the pressure profile and overall plasma stability. The motional Stark effect (MSE) diagnostic on NSTX, which measures the magnetic field pitch angle at 12 points inside the plasma, and is the only such measurement currently available for an ST, has been used to make a quantitative comparison between the measured and expected plasma current profiles.

Shown in Figure 4 is the plasma current profile as determined by the MSE data and analyzed by the LRDFIT equilibrium code. Also plotted are the total predicted current profile and its components as calculated by the TRANSP code, namely, the neutral-beam-driven current, the neoclassical pressure-driven currents according to a recent formulation that includes corrections important at low aspect ratio, and the inductively driven current. The inductive component is the product of the neoclassical plasma conductivity and the time varying toroidal elec-

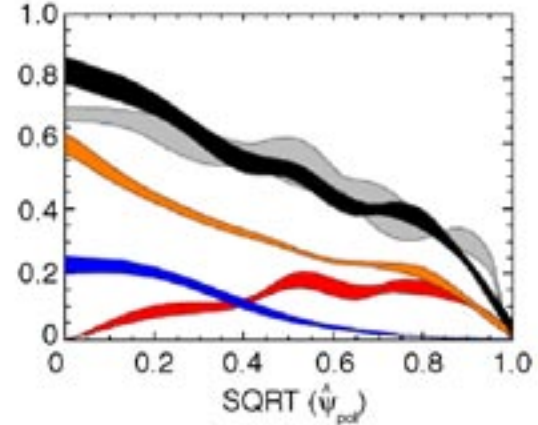

Figure 4. Radial profiles of components of the current for plasma discharge 120001. Red: bootstrap current; orange: ohmic current; blue: beam-driven current; black: total predicted current. The gray is the total current from equilibrium analysis with MSE internal field pitch data and external magnetic data. The bands represent variations during the time window indicated in Figure 1.

tric field, calculated by taking the time derivative of the poloidal flux. All parameters needed to calculate the neoclassical conductivity are measured, including the effective ion charge Z_{eff} from charge-exchange recombination spectroscopy. For the equilibrium analysis, the fast-ion pressure profile is calculated in TRANSP assuming classical slowing of the injected ions.

The plasma discharge in Figure 4 has a total noninductive current fraction of 50%, at $\beta_t \approx 20\%$ similar to the values typical of a CTF. The pressure-driven current fraction is $f_{\text{pd}} \approx 40\%$, also close to the $\sim 50\%$ required for a CTF. This discharge has a bootstrap current fraction $f_{\text{bs}} \approx 35\%$ and achieved the figure of merit $f_{\text{bs}}\beta_t \approx 7\%$, which is a record. The agreement between predicted total and measured currents is quite good with a maximum discrepancy of $\sim 10\%$. The central safety factor $[q(0)]$, which is shown in Figure 1 stays elevated for about twice the calculated relaxation time of the current profile. This persistence of an elevated central safety factor is similar to the “hybrid mode” proposed for ITER. For this discharge however, there is no obvious large-scale MHD instability to drive fast-particle diffusion. The only measured MHD modes have relatively high toroidal mode numbers $n = 3-5$ during most of the period of elevated central safety factor.

High Current Generation by Coaxial Helicity Injection

Using the hardware upgrades undertaken during FY05, the method of plasma generation in toka-

maks called “transient” coaxial helicity injection (CHI) was successfully applied in FY06 for the generation of a record 160 kA of closed flux plasma current without using a central solenoid to induce the current. The NSTX experiments also demonstrated a remarkable current multiplication factor, defined as the ratio of the plasma current to the injected current, of up to 60.

While the CHI method has previously been studied in smaller experiments, such as the Helicity Injected Tokamak (HIT-II) at the University of Washington, the results from the much larger NSTX demonstrate the exciting potential of this method. The CHI method is also applicable to tokamaks and could be used to simplify the design of a future tokamak reactor.

Coaxial helicity injection is implemented in NSTX by driving current along field lines that connect the inner and outer lower divertor plates, which are electrically separated by toroidal insulating breaks. The standard operating condition for CHI in NSTX uses the inner divertor plates and inner wall as the cathode while the outer divertor plates and passive stabilizing plates are the anode. During 2006, a 15–40 mF capacitor bank was used at up to 1.75 kV to provide the injector current. The operational sequence for CHI involves first energizing the toroidal-field coils and the poloidal-field coils to produce the desired flux conditions in the injector region. The CHI voltage is then applied to the inner and outer divertor plates and a preprogrammed amount of gas is injected in a cavity below the lower divertor plates. The gas ionizes and current begins to flow along helical magnetic field lines connecting the lower divertor plates. The applied toroidal field causes the current in the plasma to develop a strong toroidal component, the beginning of the desired toroidal plasma current. If the injector current exceeds a threshold value, the resulting $\Delta B_{\text{tor}}^2 (\mathbf{J}_{\text{pol}} \times \mathbf{B}_{\text{tor}})$ stress across the current layer exceeds the field-line tension of the injector flux causing the helicity and plasma in the lower divertor region to move into the main torus chamber. Fast time scale visible imaging of the entire process shows discharge evolution, detachment from the injector and the reconnection of magnetic field lines leading to closed flux surfaces. In some discharges the generated current persists for a surprisingly long time, about 400 ms.

In Figure 5, is shown traces for the plasma current, the injector current, and equilibrium reconstructions for a typical CHI discharge. The discharge is initiated at 5 ms after which it rapidly grows to fill the vessel within about 2 ms. Equilibrium reconstructions from discharge 120879 confirm the conclusion that a region of closed flux has formed. The experimentally measured poloidal magnetic field at 40 sensors and poloidal flux at 44 flux loops distributed poloidally are used in the computa-

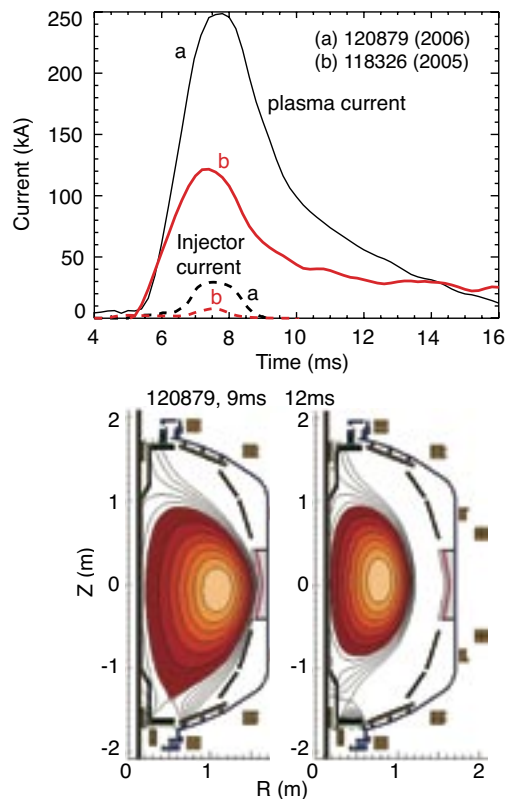

Figure 5. Plasma current and injector current from discharges during 2005 and 2006. Operation at higher capacitor bank voltages and at higher values of the injector and toroidal flux resulted in the increase in the closed flux current to 160 kA during 2006. Equilibrium reconstructions at 9 and 12 ms for the higher current discharge (shot 120879) show the production of a closed flux equilibrium.

tion of the Grad-Shafranov plasma equilibrium. The LRDFIT Grad-Shafranov equilibrium code was used for these reconstructions. The code uses a circuit equation model of the plasma, vessel, and passive plate currents to constrain the equilibrium fits. For comparison, the best result obtained during 2005 is also shown. By increasing the capacitor bank charging voltage from 1.5 kV (in 2005) to 1.7 kV (in 2006), it was possible to operate at higher values of the injector (poloidal) flux and at higher values of the toroidal field. This resulted in the magnitude of closed flux current increasing from 60 kA in 2005 to 160 kA during 2006. These results verify the high current capability of CHI for plasma start-up applications.

HHFW Heating of Inductive Plasmas

In NSTX, the radio-frequency heating power is launched into the plasma as fast waves at high harmonics, typically 20–30, of the ion-cyclotron frequency. This

high harmonic fast wave (HHFW) heating has already demonstrated heating of the electrons in ohmic plasmas for electron temperature from $T_e \approx 0.2$ keV to 1.6 keV producing a bootstrap current fraction up to 80%. If higher electron temperature CHI target plasmas could be produced, HHFW should be capable of further heating and increasing the plasma current through bootstrap and direct HHFW current drive. However, parasitic losses from parametric decay instabilities (PDI) have also been shown to increase in severity at the lower parallel wavenumber, k_{\parallel} , needed for HHFW current drive.

This year, as shown in Figure 6(a), wave fields far from the antenna were measured to increase as the parallel wavenumber was lowered. This is consistent with enhanced surface wave excitation and losses at the very low cutoff density associated with low parallel wavenumber. Both parametric decay instabilities and surface waves are expected to be reduced at higher toroidal field or higher parallel wavenumber.

Taking advantage of this new understanding and operating at the highest allowable toroidal field of 0.55 T, Figure 6(b) shows electron temperature values approaching 4 keV achieved with current-drive phas-

ing during the 2006 experiments. Previously, such high electron temperature was only achievable with heating phasing ($k_{\parallel} = 14$ m⁻¹). These results improve the prospects for utilizing wave heating and current ramp-up of CHI target plasmas to initiate high-performance ST plasmas.

Error Field Correction and Resistive Wall Mode Stabilization

Maintaining plasma stability at the highest possible pressure is of interest to NSTX, burning plasma experiments such as ITER, and future energy producing devices.

To increase plasma stability in NSTX, there are 48 toroidally segmented copper plates, covered with carbon tiles on the plasma-facing side, arranged symmetrically in four toroidal rings, two above and two below the device midplane. These plates stabilize the plasma against several types of MHD instabilities because eddy currents are induced in them which oppose any deformation of the plasma column. This allows the plasma pressure to be raised above the normal threshold for instability. However, if the pressure is sustained near this “wall-stabilized” limit, new instabilities known as resistive wall modes (RWMs) can grow on the timescale for the stabilizing eddy currents to decay due to the electrical resistance of the wall material. This tendency can be counteracted if the plasma can be made to rotate toroidally inside the conducting wall with an angular velocity exceeding a critical value, Ω_{crit} , which is typically a few percent of the Alfvén frequency ω_A .

Nonaxisymmetric error fields (EF) caused by small, possibly dynamic, coil misalignments can play an important role in initiating RWMs. Theory predicts that by controlling these error fields the onset of the RWM can be delayed or suppressed in rotating plasmas. NSTX is equipped with a set of six mid-plane ex-vessel coils, known as RWM/EF correction coils, producing controllable radial magnetic fields with $n = 1$ or $n = 3$ toroidal symmetry. These can be used both to excite and then to stabilize the RWM.

Resistive wall modes research in NSTX during 2006 focused on active stabilization of the $n = 1$ RWM at low-rotation speeds, similar to those expected in ITER. This can be achieved by a feedback control loop consisting of magnetic sensors capable of detecting the spectrum of low-frequency magnetic perturbations, a set of control coils to provide a correcting magnetic field, and a control algorithm that determines the form of the response.

The experiments demonstrated for the first time active stabilization of the pressure-driven RWM in high-beta, low-aspect-ratio tokamak plasmas, with toroidal

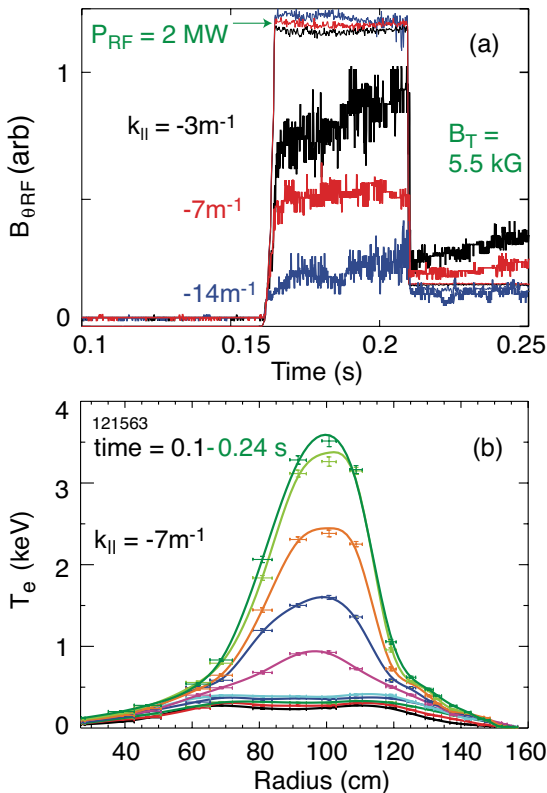

Figure 6. (a) Far-field high harmonic fast wave B_{θ} amplitude versus launched k_{\parallel} , and (b) $T_e(t,R)$ for an $I_p = 700$ kA, $B_T = 5.5$ kG plasma with 2 MW of high harmonic fast wave.

rotation significantly below the critical rotation over the entire profile. The plasma toroidal rotation was controlled in these experiments by the application of non-resonant, $n = 3$ magnetic braking. The rotation speed normalized to the Alfvén speed approached the level expected for ITER plasmas. A comparison of high beta-normalized (β_N) plasmas with and without RWM active stabilization is shown in Figure 7.

With active stabilization turned off, the current in one of three control coil pairs, I_A , is the pre-programmed $n = 3$ braking field current [Figure 7(c)]. The experimentally fitted $n = 1$ RWM growth rate is $0.5\text{--}0.25\text{ s}^{-1}$. This agrees well with the theoretical growth rate of 0.37 s^{-1} computed by the VALEN-3D code using experimental plasma equilibrium reconstructions including internal magnetic field pitch angles from the MSE diagnostic. This value is used as the RWM growth rate, γ_{RWM} . In contrast, the plasma with active stabilization (solid curves) does not suffer an unstable RWM

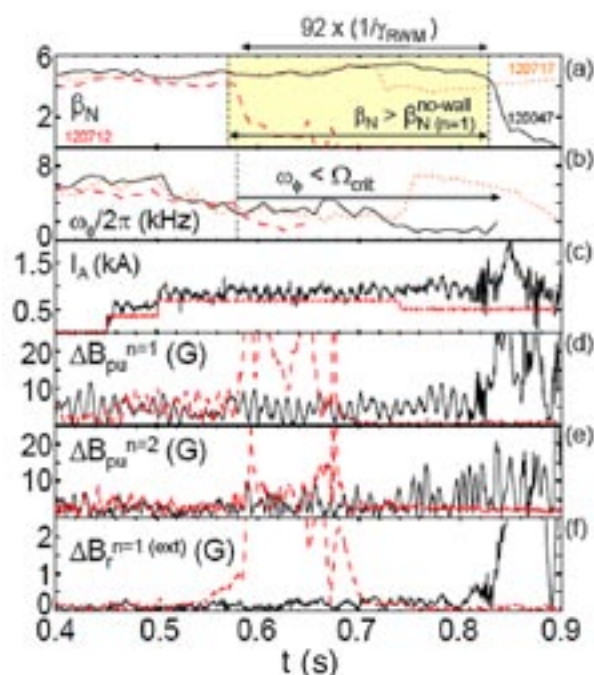

Figure 7. Resistive wall mode (RWM) active feedback stabilization in low-rotation plasmas. Solid curves: actively stabilized plasma at $\omega_\phi < \Omega_{\text{crit}}$. Dashed curves: RWM unstable plasma at $\Omega_{\text{crit}}/\omega_A = 1$ with active feedback turned off. Dotted curves: (upper two frames) actively stabilized plasma suffering a beta collapse from an internal $n = 2$ plasma mode. Shown are the evolution of (a) β_N , (b) ω_ϕ near $q = 2$, (c) current in representative nonaxisymmetric control coil, (d) and (e) mode amplitude of $n = 1$ and 2 field components measured by the upper B_p sensor array, and (f) field components at the midplane, external to the vacuum vessel.

and continues to increase in normalized beta to 5.6% m·T/MA and toroidal beta to 19.4%, as the angular toroidal rotation frequency, ω_ϕ , continues to decrease to $\Omega_{\text{crit}}/\omega_A = 0.2$ near $q = 2$ before the end of the discharge. The RWM is actively stabilized above the stability limit calculated without the wall stabilization and below Ω_{crit} for a duration exceeding $90/\gamma_{\text{RWM}}$ and ~ 7 energy confinement times. The control coil current is the superposition of the $n = 3$ braking field current and the $n = 1$ feedback stabilization current which is determined by the measured $n = 1$ RWM amplitude and phase.

The rotation profiles of actively and rotationally stabilized discharges are shown in Figure 8. All discharges have constant neutral-beam power of 6.3 MW. The plasma without active stabilization (dashed curves) reaches $\beta_N = 4.1$ as $\omega_\phi/2\pi$ at major radial position $R = 1.323\text{ m}$ drops to below 4 kHz. This radial position is chosen since it is near the $q = 2$ flux surface. At this time, RWM passive stabilization becomes insufficient and the $n = 1$ RWM becomes unstable, indicated by poloidal and radial field sensors (ΔB_p , $\Delta B_{r\text{-ext}}$) and normalized beta collapses.

In NSTX, low-density locked-mode threshold experiments have identified $n = 1$ error field components of 1–3 G calculated at the $q = 2$ surface near $\rho_{\text{pol}} \equiv (\Psi_{\text{pol}})^{1/2} = 0.7\text{--}0.8$. Additional experiments at higher beta revealed error fields of similar magnitudes but of opposite polarity. The source of this variable error field has since been traced to a small motion of the toroidal-field (TF) central conductor bundle relative to the vacuum vessel and poloidal-field (PF) coils caused by electromechanical interaction with the ohmic-heating (OH) sole-

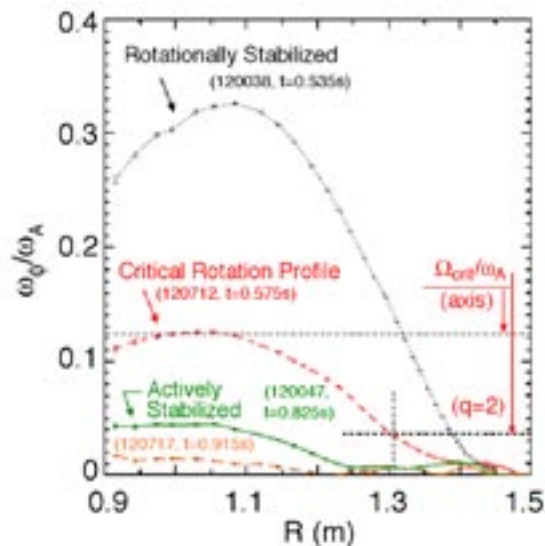

Figure 8. Plasma rotation profiles for plasmas that are rotationally stabilized, are at RWM marginal stability (critical rotation profile), and are actively stabilized below Ω_{crit} .

noid. The error field is measured to be proportional to the time-delayed and partially rectified product of the OH and TF coil currents. Correction of this error field has been attempted using several control methods.

First, as seen in Figure 9, correction of the OH \times TF error field (black curves) utilizing a real-time estimate of the toroidal-field coil motion increases the pulse duration above the no-wall limit by approximately 50% relative to no correction (red curves) during the high normalized beta phase. The addition of gain and phase-optimized closed-loop feedback control of the measured in-vessel $n = 1$ poloidal field to OH \times TF correction can double the duration above the no-wall limit (green curves). Additional tests in these discharges find that closed-loop $n = 1$ feedback alone does not provide robust pulse extension early in the high normalized beta phase, and that the OH \times TF correction is not yet optimized late in the high normalized beta phase. Finally, using the time-average of the OH \times TF plus closed-loop $n = 1$ feedback coil currents (blue curves) provides nearly identical performance as the nonaveraged coil currents. Because the measured RWM growth time is much shorter than the averaging time used in these experiments, this result implies that the feedback control system is responding to plasma-induced error-field amplification and is aiding in sustaining the plasma rotation which stabilizes the RWM.

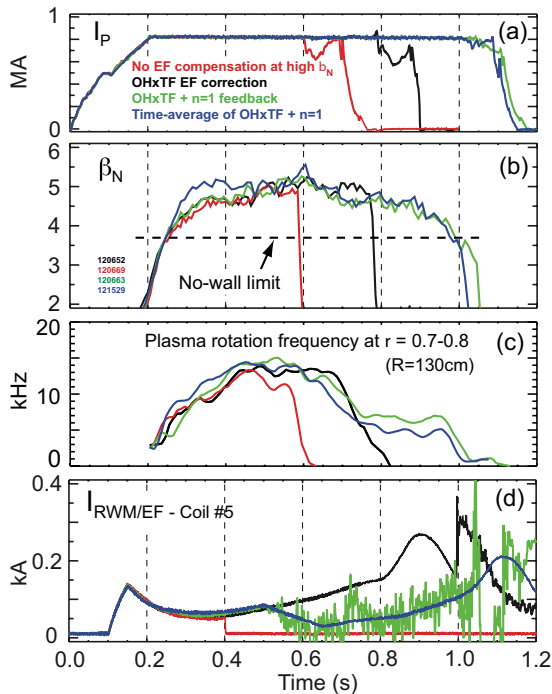

Figure 9. (a) Plasma current, (b) normalized beta, (c) plasma rotation near $q = 2$ and 3 surfaces, and (d) RWM/EF coil current during dynamic error field correction experiments.

Energetic Particle Studies

The NSTX is particularly well suited to investigate fast-ion driven instabilities of relevance to ITER and STs because large values of the dimensionless parameters $v_{\text{fast}}/v_{\text{Alfvén}}$ and $\beta_{\text{fast}}(0)/\beta_{\text{tot}}(0)$ required to drive such instabilities occur routinely in neutral-beam-heated plasmas. The instabilities can be divided into three categories: chirping energetic particle modes (EPM) in the frequency range 0–120 kHz, the toroidal Alfvén eigenmodes (TAE) with a frequency range of 50–200 kHz, and the global and compressional Alfvén eigenmodes (GAE and CAE, respectively) between 300 kHz and the ion-cyclotron frequency.

These modes are of particular interest because of their potential to cause substantial fast-ion redistribution or loss. Neutral-beam-heated plasmas can match and exceed the fast-ion beta and velocity ratio $v_{\text{fast}}/v_{\text{Alfvén}}$ of ITER with complete diagnostic coverage including MSE. In NSTX, cyclic drops in the deuterium-deuterium fusion neutron rate have been associated with the destabilization of multiple large TAEs, which are similar to the “sea-of-TAEs” predicted for ITER, albeit at lower TAE toroidal mode number, typically $n = 1$ – 6 . Data from the neutral particle analyzer show a deficit in the fast particle population which is most pronounced below half of the primary beam energy. The density of the highest energy ions is modulated by roughly 10%.

Figure 10 compares the mode frequencies, fluctuation amplitudes, and neutron rate decrements during single-mode and multi-mode TAE burst events. An important finding evident in this figure is that multi-mode bursts lead to five times higher fast-ion losses than single-mode events despite having 2 to 3 times lower root-mean-square (rms) magnetic field fluctuation amplitude (0.15–0.2 G versus 0.3–0.5 G). This implies that the structure and multiplicity of TAEs is just as important as mode amplitude in determining the mode-induced fast-ion transport. Interestingly, recent NSTX results indicate that multi-mode coupling is not constrained to a single class of fast-ion instability.

Figure 11(a) shows that TAEs can coexist with EPMs, and bicoherence analysis indicates that an $n = 1$ EPM can couple to two higher- n (and higher frequency) TAEs through a three-wave coupling process. In fact, the dominant EPM can drive the TAE amplitude envelope to be toroidally localized during mode propagation as shown in Figure 11(b). The data in Figures 10 and 11 together imply that the structure, multiplicity, and nonlinear coupling characteristics of multiple fast-ion instabilities could all play a role in determining fast-ion transport in future ST devices and ITER.

In NSTX, multiple reflectometers make localized density perturbation measurements at different radii

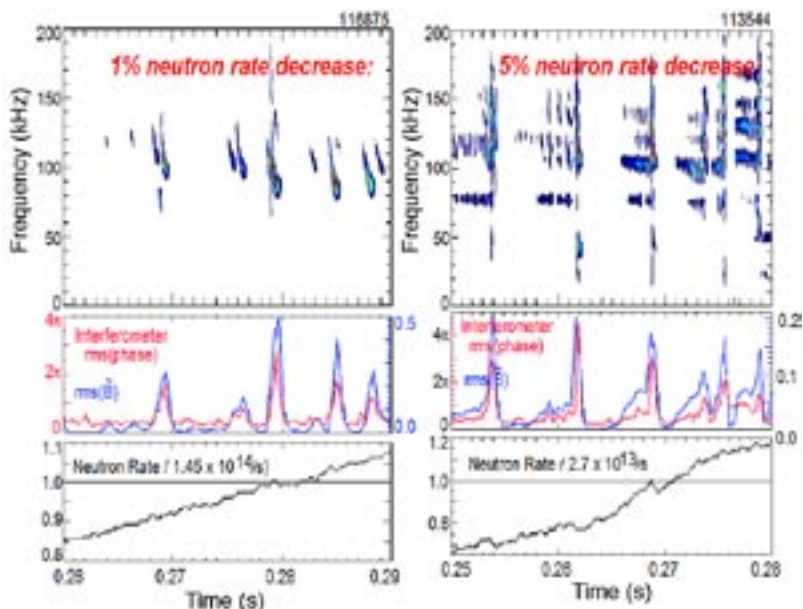

Figure 10. (top) Mode frequency spectra, (middle) density fluctuation and Mirnov oscillation amplitudes, and (bottom) neutron rate decrements during single-mode TAE (left) and multi-mode TAE (right) bursts.

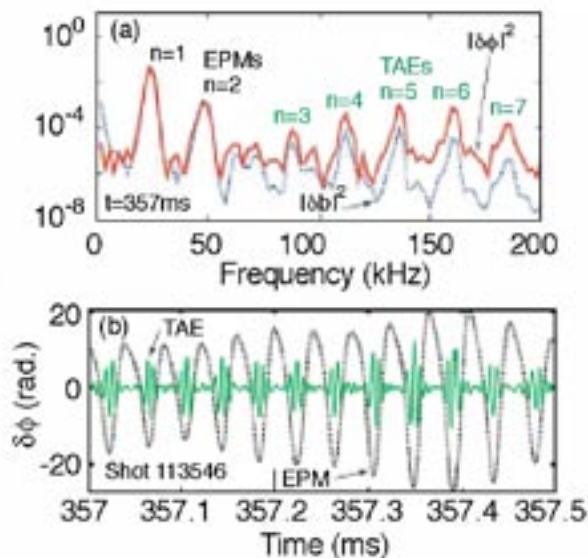

Figure 11. (a) Mirnov and reflectometer spectra showing multiple energetic particle modes and TAE modes, and (b) toroidal localization of TAE amplitude envelope from three-wave coupling to $n = 1$ edge particle modes.

on the low-field side, permitting investigation of mode structure. Additionally, radial 1-mm microwave and tangential far infrared interferometers are sensitive to mode activity across the entire plasma, including the high-field side, further constraining the mode structure. This year, the structures of both the “fishbone” EPM and the TAEs were investigated.

Transport Physics

The low aspect ratio and wide range of beta values accessible in NSTX (toroidal beta up to 40%) provide unique data for understanding the dependence of energy confinement on these parameters for the ST and for ITER. Initial high-confinement mode (H-mode) energy confinement scaling studies for NSTX found a weaker dependence on plasma current than at conventional aspect ratio and a stronger dependence on the toroidal magnetic field. The NSTX H-mode confinement data has been incorporated into international confinement databases, and scalings including this and higher aspect ratio data indicate a stronger positive dependence on inverse aspect ratio and a weaker beta dependence than in the commonly used ITER98PB(y,2) scaling.

More recent experiments have elucidated the distinct roles of ion and electron thermal transport in the global energy confinement scaling. In particular, increasing toroidal magnetic field from 0.35 to 0.55 T resulted in a broadening of the electron temperature profile and a reduction in the electron thermal diffusivity, χ_e , in the outer half of the plasma minor radius. Interestingly, the central electron temperature increased only 10–20% during this scan. As the plasma current was increased from 0.7 to 1.0 MA, the ion transport was reduced in the outer half of the plasma minor radius, consistent with neoclassical transport. Thus, it appears that the electron transport largely determines the toroidal-field scaling, while the neoclassical ion transport largely determines the plasma current scaling.

In the NSTX H-modes described above, the electron energy transport is anomalous. To investigate possible causes of this, a 280-GHz (~ 1 mm) microwave scattering diagnostic has been implemented on NSTX to measure turbulent density fluctuations on the scale of the electron gyroradius. Figure 12(a) shows a plan view of the microwave beams for scattered rays accepted by the collection waveguides of the system. The system provides the ability to scan radially from near the magnetic axis to near the edge with high radial spatial resolution, ~ 6 cm. It measures fluctuations with a predominantly radial wavenumber k_r from 2 to 24 cm^{-1} , which spans the range from ion- to electron-scale turbulence. Data from this diagnostic will provide strong tests for theories of anomalous electron energy transport of particular importance to developing a first-principles predictive capability for electron energy transport for ITER and magnetic confinement devices in general.

With the high- k system viewing at large major radius [Figure 12(a)], Figure 12(b) shows a large reduction in fluctuation levels after the transition from low-confinement mode (L-mode) to H-mode for nearly all radial wavenumbers measurable by the system. Interestingly, the highest $k_r = 24$ cm^{-1} signal exhibits amplitude bursts during H-mode which correlate with edge-localized mode (ELM) events. We are attempting to determine if these bursts correspond directly to ELM-induced den-

sity perturbations of short radial scale length, or are instead due to beam refraction effects.

The availability of MSE data has improved understanding of the role of magnetic shear in energy transport. In particular, reversed magnetic shear has been demonstrated to allow the formation of electron energy transport barriers in L-mode discharges. The improvement in electron energy confinement correlates with the degree of measured magnetic shear reversal.

These L-mode discharges which are typically heated with one NBI source (1.6–2 MW), achieve electron temperatures up to 2 keV and transient energy confinement times $\tau_E = 80$ –100 ms. However, they have low normalized beta limits $\leq 4\%$ m·T/MA and low noninductive current fractions relative to comparable positive-shear, H-mode discharges heated with 4–7 MW which reach $T_e \leq 1.2$ keV. The apparent high- k density fluctuation amplitude in the high electron temperature L-mode discharges does indicate some dependence on magnetic shear, but firm conclusions cannot yet be drawn.

In addition to the study of equilibrium transport properties, edge temperature perturbations induced by injecting a solid pellet into the plasma have allowed the core electron transport response to be probed. The two kinds of discharges described above exhibit very different transport responses. Figure 13(a) shows the electron temperature evolution in a positive-shear H-mode discharge ($P_{\text{NBI}} = 5.5$ MW, $I_p = 0.7$ MA, $B_T = 0.45$ T). These data are obtained from “two-color” ultra-soft X-ray (USXR) tomography. Following the pellet perturbation, the core electron temperature gradient scale-length [Figure 13(b)] is essentially constant, consistent with the existence of a critical temperature gradient. In contrast, for the reversed-shear L-mode plasma [Figure 13(c)], the core electron temperature actually increases after pellet injection and there is a significant decrease in the temperature gradient scale-length [Figure 13(d)]. The ability to create and diagnose scenarios with large variations in electron transport while ion turbulence is largely suppressed makes NSTX particularly well-suited for studying electron transport physics.

Edge Physics

Radiative Divertor Experiments

Improved understanding and control of both steady-state and transient heat fluxes to the divertor and other plasma-facing components are essential for the successful operation of ITER and future ST devices such as an Spherical Torus-Component Test Facility (ST-CTF).

In NSTX, reductions in peak divertor heat flux have been achieved using both detached and radiative divertor scenarios via gas puffing at the inner strike

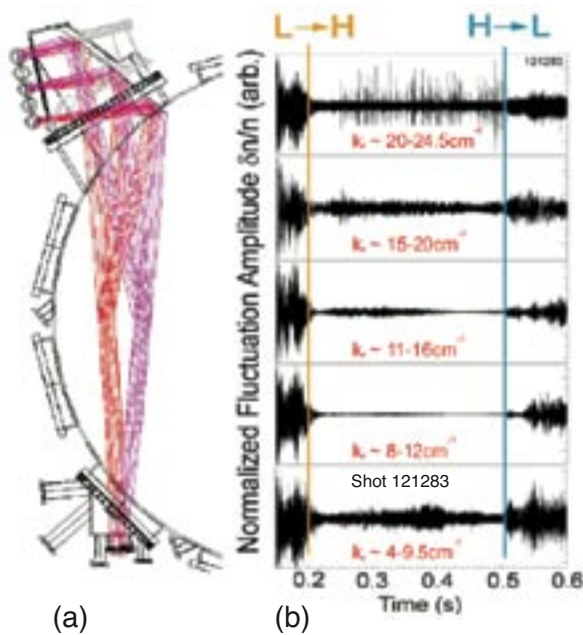

Figure 12. (a) Radially scannable high- k scattering diagnostic as viewed from above, (b) $\delta n/n$ fluctuation levels (normalized to initial L-mode values) in L-mode and H-mode of a $P_{\text{NBI}} = 2$ MW, $I_p = 0.8$ MA, $B_T = 0.45$ T plasma discharge.

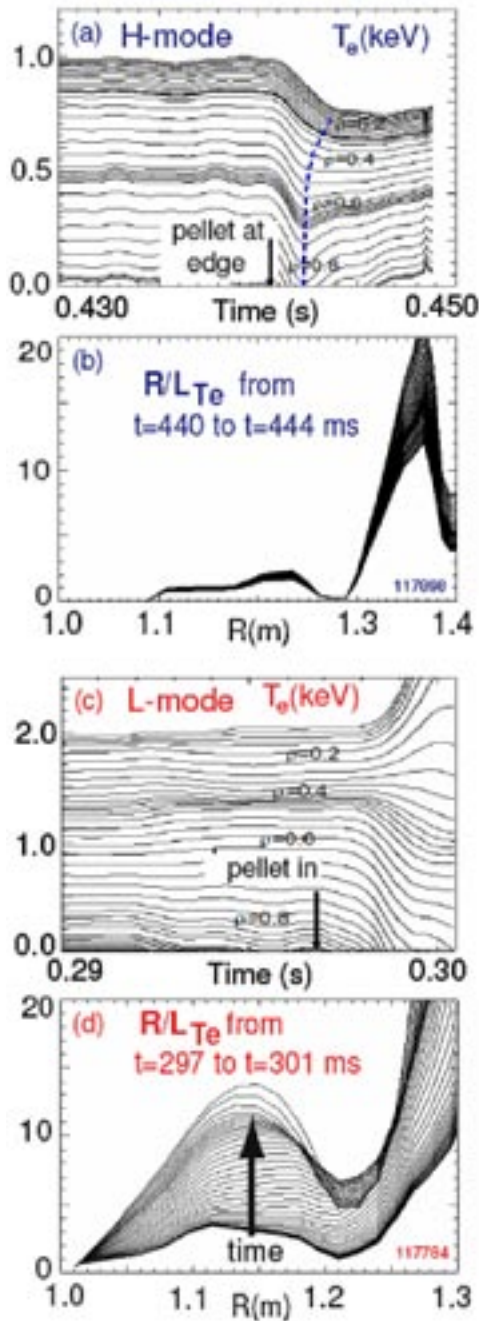

Figure 13. (a) T_e and (b) T_e gradient evolution in H-mode, and (c) T_e and (d) T_e gradient evolution in L-mode during edge perturbations induced by lithium pellet injection.

point and/or private flux region in lower single-null divertor discharges. The inner strike point of NSTX divertor discharges is typically observed to be fully detached, while the outer strike point is attached. With sufficient deuterium gas injection in the divertor, it is also possible to partially detach the outer strike point, but thus far this has led to deleterious MHD activity and loss of the H-mode. However, with reduced gas

input, a “radiative divertor” regime has been developed which also produces significant reductions in peak divertor heat flux.

Figure 14 shows that the gas injection required in the divertor has no apparent impact on H-mode confinement, while there is a modest decrease in core carbon concentration and radiation. Importantly, the peak heat flux is reduced by a factor of five prior to the onset of beta-limiting MHD in both the reference and radiative divertor discharge. Recent experiments also indicate that the peak divertor heat flux is a strong function of heating power and plasma current.

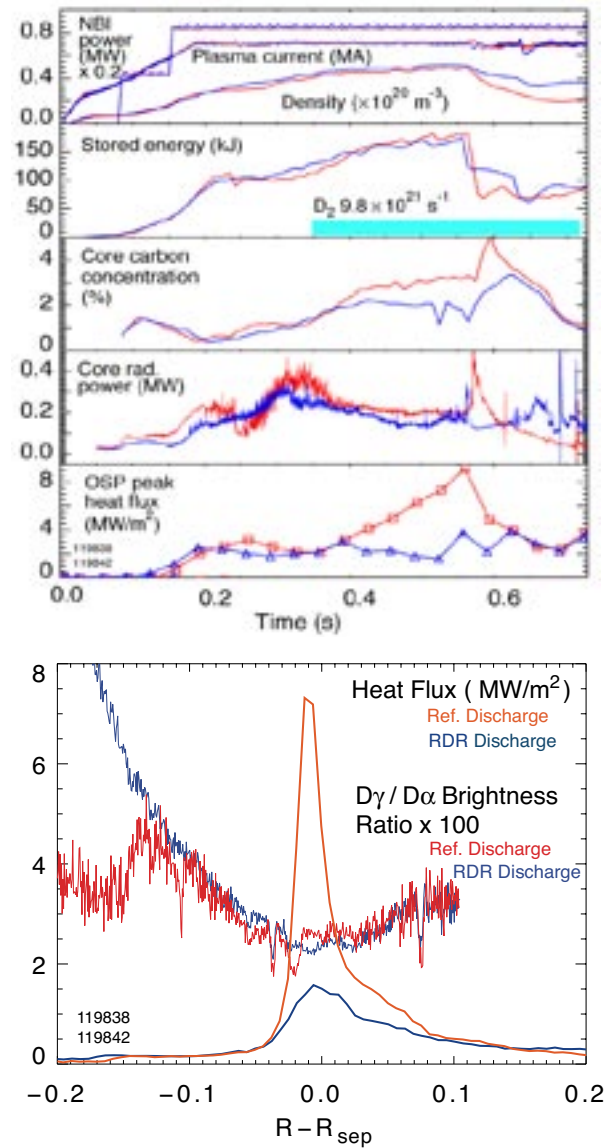

Figure 14. Deuterium puffing the lower divertor region through the gap between the lower divertor plates at a rate of 160 Torr-l/s was used to produce this radiative divertor regime, which reduces the peak divertor heat flux by a factor up to 5.

Lithium Evaporator

The NSTX is pursuing a staged approach to the development of lithium plasma-facing components (PFCs). This year NSTX used a lithium evaporator, dubbed LITER-1, to achieve more extensive coating of PFCs, notably the lower centerstack and divertor region, as shown in Figure 15. Twelve separate evaporations were conducted, depositing from 14 mg to 4.8 g of lithium.

In NSTX, H-mode discharges exhibit very good particle confinement with the result that the density increases secularly throughout the plasma discharge. These discharges were expected to be the most challenging plasma scenarios to achieve density control using lithium coating. In the first discharge after depositing at least 400 mg of lithium, lower edge recycling light and a reduction in density were observed early in reference H-mode discharges. However, the density rate of rise later in the discharge returned to that observed before coating. Figure 15 shows the modest 10–15% density decrease achieved after lithium coating late in H-mode discharges. The evaporated lithium coating was observed to have a more pronounced effect on other discharge parameters. As seen in Figure 15, in the best cases following lithium evaporation, there was a significant reduction in plasma Z_{eff} and increases in the electron and ion temperatures by up to 25% and 40%, respectively. The confinement enhancement factor relative to ITER98PB(y,2) H-mode scaling improved from ~ 1.1 to ~ 1.3 . Such enhancements improve the prospects for achieving the fully noninductive scenarios.

Supersonic Gas Injector

The H-mode discharges in NSTX are routinely fueled using the high-field-side (HFS) center stack gas injector, a system that injects gas through a small orifice located at the midplane along the center stack. Although this enables reliable H-mode access, it has a drawback that the gas feed continues throughout the discharge resulting in a continuous density rise. This year, the NSTX supersonic gas injector (SGI) was successfully used to produce H-modes without relying on the high-field-side gas injector and demonstrated the possibility of controlling the density rise during the H-mode phase.

Edge Turbulence Imaging and Modeling

Edge turbulence continues to be studied in NSTX using “gas puff imaging” (GPI), in which a fast camera measures the light emitted by neutral atoms which is modulated by fluctuations in edge density and temperature. The edge is normally very turbulent on a spatial scale of a few centimeters and a timescale of a few tens of microseconds, exhibiting moving regions of increased density and temperature, frequently referred

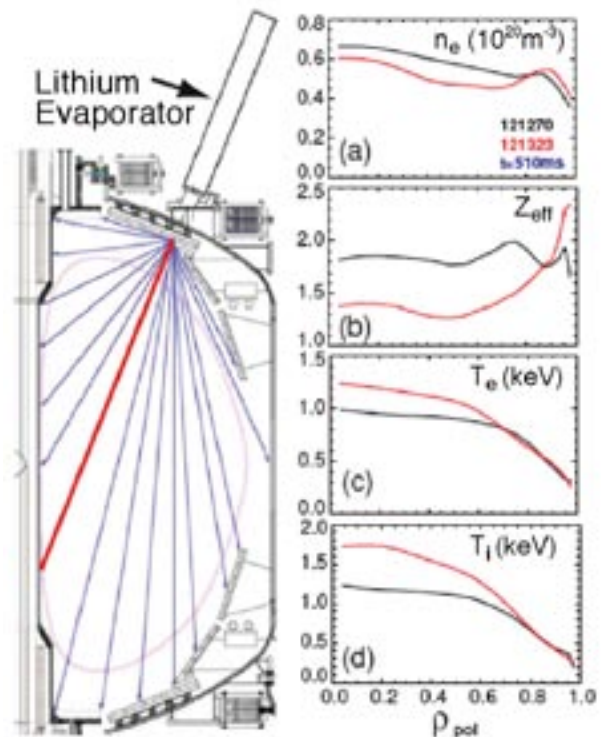

Figure 15. Cross section of NSTX showing the placement of the LITER-1 evaporator and comparisons of plasma parameters before (black) and after (red) lithium evaporation: electron density (n_e), electron temperature (T_e), ion temperature (T_i), and Z_{eff} .

to as plasma “blobs.” This turbulence is likely to be the cause of the particle and heat loss to the wall. Therefore measurements of the structure and motion of this turbulence by gas puff imaging can be used to help understand the edge plasma transport.

The edge becomes much quieter after a transition from the L-mode to the H-mode of confinement. Recent gas puff imaging analysis has focused on trying to understand this transition. Surprisingly, the radial size scale and poloidal flow of the turbulence do not change as expected from the generic “shear flow stabilization” model of the L-H transition. The analysis of image data has shown, for example, that blobs are more elongated and less frequent in H-mode compared to L-mode discharges. Blob radial motion analysis has shown good agreement with a theoretical model of Myra, which postulates that highly nonlinear edge plasma turbulence produces coherent structures with enhanced concentrations of density, temperature, and vorticity. These become charge polarized and the resulting electric field causes an $\mathbf{E} \times \mathbf{B}$ drift down the toroidal magnetic field gradient on the low-field side of the torus. By this mechanism, the grad-B and toroidal curvature forces can move the blob into the scrape-off-layer (SOL) and towards the wall at

about 1% to 5% of the local plasma sound speed. While previous work has established the qualitative validity of blob propagation models, this year's work represents the first detailed experimental confirmation of theory-based bounds and scalings. The observation of blobs in the far scrape-off-layer implies cross-field density transport which exceeds parallel particle flow to the divertor. Fast moving blobs (e.g., in the high collisionality limit) are predicted to influence power transport as well, and are of interest for understanding wall damage and the scrape-off-layer width.

The DEGAS 2 code has been used to simulate gas puff imaging experiments, yielding an estimate of the 3-D neutral density associated with the gas puff. The color image (Figure 16) is the result of the simulation. The 25%, 50%, and 75% contours of the observed emission are overlaid. The peaks and widths of the simulated and observed emission clouds agree to within the estimated uncertainties in the calculation.

The fast reciprocating probe which measures the ion saturation current and radial and poloidal electric fields in the edge plasma with a time resolution of 2 ms was used to study the edge of H-mode plasmas with line-averaged densities normalized to the Greenwald density limit, $n_G = 0.4\text{--}0.75$.

It was found that the scrape-off-layer density develops a plateau at the highest densities, and exhibits increasing fast, intermittent transport. As the discharge density increases, the H-mode pedestal density also increases. This is most significant at normalized densities $n_G > 0.6$ at which point the pedestal temperature starts to drop.

The data indicate that the root-mean-square (rms) fluctuation level of the ion saturation current (I_{sat}) increases with density and peaks just inside the last closed flux surface (LCFS) dropping monotonically in the scrape-off-layer and also in the core. This suggests that the intermittent events are created in such region. The I_{sat} and poloidal electric field E_{pol} rms levels increase only at the highest densities. Furthermore, the probe data indicates the presence of density dips or "holes" inside the LCFS, mixed with spikes, consistent with a behavior suggestive of interchange instability and with this region being the source of the radially moving plasma filaments.

Fast Imaging of MARFEs and ELMs

A fast imaging camera with a frame rate capability of 68,000 frames/s (at 128 by 128 pixels) or 120,000 frames/s (at 64 by 64 pixels), with 2- μs frame exposure and 12-bit digitization has revealed a complex cyclic interplay between MARFEs (Multi-faceted Axisymmet-

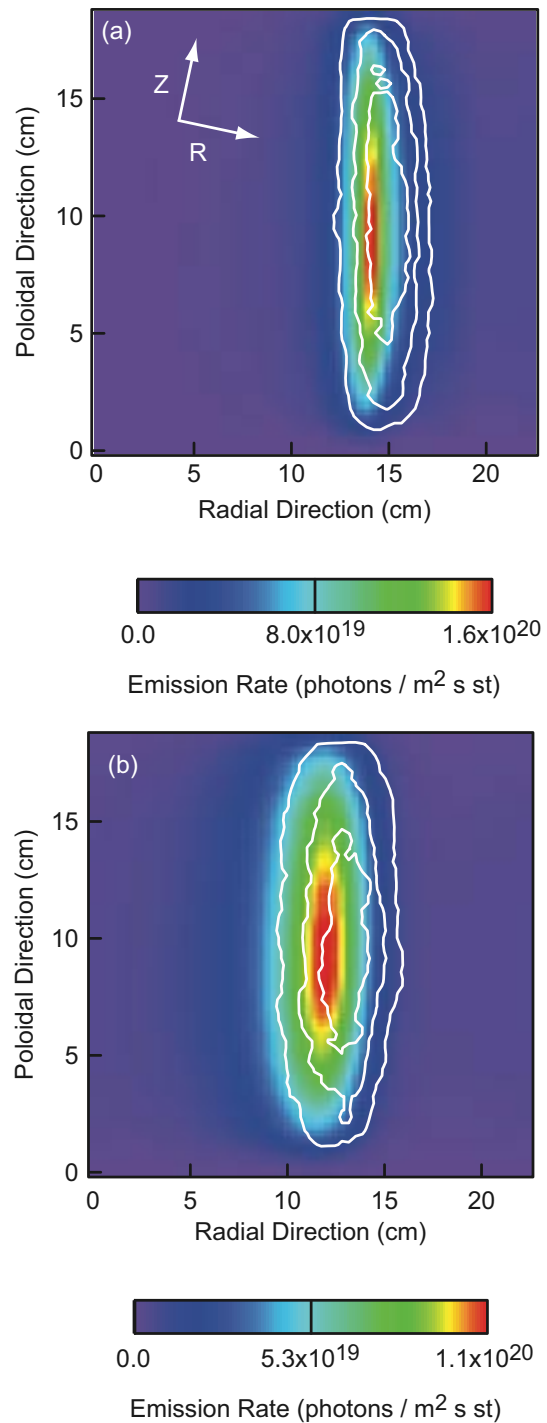

Figure 16. DEGAS 2 code simulations of gas puff imaging compared to experimental measurements for the H-mode plasma discharge 112811 and the L-mode plasma discharge 112814. The color image is the simulation. The white contours are the experimental observations. The peaks and widths of the simulated and observed emission clouds agree to within the estimated uncertainties in the calculation.

ric Radiation From the Edge) and ELMs (Edge Localized Modes) in NSTX. The images show that the toroidally symmetric MARFE moves downward along the center stack (along the ion- ∇B direction). The ELM activity in the lower divertor coincides with burn through of most of the MARFE resulting in a toroidally localized high-density plasmoid. This toroidally localized MARFE precursor then moves back up along the center stack, following field lines. The upward movement stagnates and the MARFE precursor expands into a toroidally symmetric structure, that once again moves down.

The Type V ELMs (which were previously discovered in NSTX) are seen to propagate poloidally, consistent with the observations from the FIRETIP diagnostic and corresponding to a momentary shift of the D_α emission layer, as well as a perturbation of the edge magnetic surfaces. The filament itself carries ~ 400 A of current.

This year the interaction of edge plasmas with NSTX plasma-facing surfaces was studied using an array of Langmuir probes flush mounted with the plasma-facing surfaces of the divertor plate and inner wall tiles. The probe array consists of three probes each on the lower and upper outer divertor plate, one on the lower and upper inner divertor plates, and 10 probes along the inner wall. Probe voltage sweep frequencies of 50 and 100 Hz were used. The radial variation in the shape of the ion saturation current on the outer divertor plate was found to be similar to the divertor heat flux profile as measured by the infrared divertor camera.

Dependence of the H-mode Pedestal on Aspect Ratio

As part of an International Tokamak Physics Activity (ITPA) research task, dedicated scans of the neutral-beam heating power and the plasma density were performed in plasmas with a cross section similar to DIII-D

and MAST (Mega-ampere Spherical Tokamak). A reasonable match to the shapes was obtained and discharges with two different pedestal electron collisionality ($\nu_e^* \approx 1$ and 0.5) were produced. The reduced density required for the lower collisionality discharge was produced by first running a helium conditioning plasma discharge, in addition to the usual helium glow discharge cleaning (HeGDC). The lower collisionality discharge was ELM free suggesting a higher beta limit in the edge. Similar scans have been conducted on DIII-D and are now being conducted on MAST.

Behavior of Dust Particles

The behavior of dust in fusion research devices has been identified as a high priority research topic under the ITPA. Recently, two fast cameras viewing the same plasma volume inside NSTX from almost orthogonal sightlines were utilized to track individual dust particles and derive their trajectories under real operating conditions. These trajectories will be used as input into transport codes which model the behavior of dust in the plasma environment.

Helium Glow Discharge Cleaning

Glow discharge cleaning in NSTX has hitherto relied on two fixed anodes attached to the vessel wall. This year, a movable anode, which can be inserted to a radius of 0.77 m, was commissioned. The effects of HeGDC with the two fixed anodes and with a combination of one fixed and the insertable anode were studied. It was found that the fixed and insertable anodes gave comparable performance for achieving reference 1-s, 1-MA pulses. Variation of the pressure during the HeGDC between 2 and 4 mTorr did not affect discharge performance or extend the duration, indicating that the HeGDC used in NSTX is optimized.

National Compact Stellarator Experiment

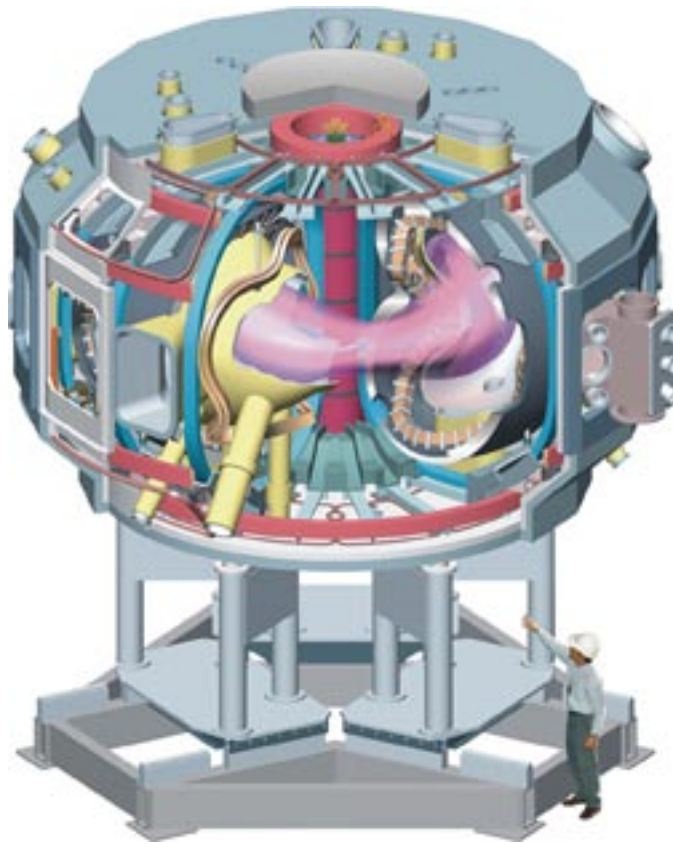

National Compact Stellarator Experiment

The National Compact Stellarator Experiment (NCSX) is a new magnetic confinement fusion experiment, currently being constructed at the Princeton Plasma Physics Laboratory (PPPL) in partnership with the Oak Ridge National Laboratory (ORNL). It will be used to acquire physics data needed to evaluate the compact stellarator as a fusion concept and to advance the physics understanding of 3-D plasmas for fusion and basic science. In addition, technological developments made in the course of constructing NCSX, for example the design and manufacture of complex-shaped parts, are important contributions to fusion technology.

Among the family of toroidal magnetic plasma configurations, stellarators are of interest because they solve

important problems for fusion energy — achieving steady-state operation and avoiding disruptions. Stellarators have unique flexibility to resolve scientific issues, for example the effects of 3-D plasma shaping and of strong external control on confinement, that are important to all magnetic configurations.

The compact stellarator shares the attractive properties of existing stellarators but has the additional advantages of lower aspect ratio and a quasi-symmetric magnetic field structure. In a quasi-*axisymmetric* stellarator (QAS) like NCSX, the charged-particle trajectories and plasma flow damping are similar to those of its axisymmetric relative, the tokamak, so a QAS is expected to share the tokamak's good confinement performance. This physics link with tokamaks means compact stel-

larators can advance rapidly and economically, combining stellarator advantages with advances in the more mature tokamak concept, including the expected future advances in burning plasma physics and technology from ITER.

NCSX Stellarator Configuration

The compact stellarator is a result of the large advances in plasma physics understanding and computation that have occurred in recent years. The NCSX was designed by performing computer simulations of hundreds of thousands of plasma configurations to optimize the physics properties: stability at high beta, degree of quasi-axisymmetry, quality of magnetic surfaces, and aspect ratio. Algorithms based on the free-boundary VMEC and PIES equilibrium codes were used to optimize the coil geometry, targeting the desired physics properties while satisfying coil feasibility metrics such as minimum bend radius, minimum coil-to-coil spacing, and minimum coil-to-plasma spacing. Research on NCSX will test this modern approach to experiment design.

The NCSX plasma is designed to have an aspect ratio of 4.4 instead of the more typical (for stellarators) values of about 10; to have a quasi-axisymmetric magnetic field with an effective ripple less than 1.5%; to be MHD stable without active feedback control, current drive, or rotation drive; and to have good magnetic surfaces, all at high beta (4%). The magnet system consists of eighteen modular coils, six groups each composed of three different shapes (Figure 1), plus toroidal-field coils, poloidal-field coils, and helical-field trim coils. These coils generate the 3-D magnetic fields required to realize the target equilibrium properties and provide the flexibility to vary the plasma configuration and test the physics. The device size (major radius $R = 1.4$ m), magnetic field range ($B = 1.2$ – 2.0 Tesla), pulse length (0.3–1.2 s), and planned plasma heating power (≥ 3 MW) are set to produce the plasma conditions and profiles needed to test critical physics issues over a range of beta and collisionality values. The NCSX machine was designed on the basis of this configuration and these parameters and is now well into construction.

Component Production Progress

Production of major device components was the NCSX Project's main focus in FY06. The year began with the delivery of the first modular coil winding form to PPPL. Modular coil fabrication began immediately thereafter, applying the process developed through fabrication and testing of the "twisted racetrack" R&D coil the preceding year. During FY06, coil manufacturing operations passed through a start-up phase marked by improvements in process efficiencies and delivery inter-

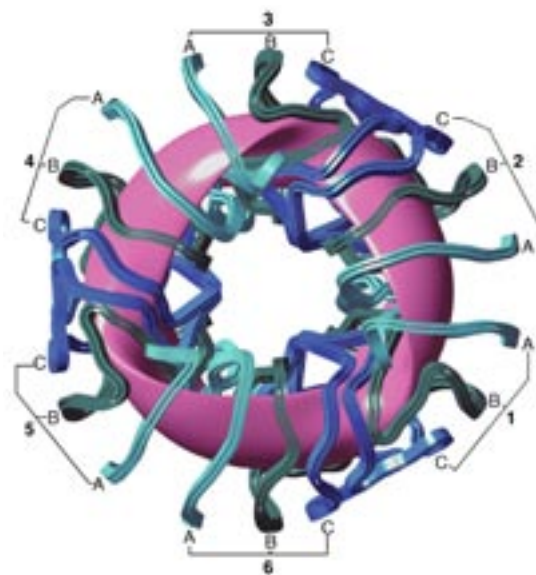

Figure 1. NCSX plasma and modular coils.

vals. By year's end, modular coil winding forms were being produced at the target rate of one per month, with eight having been delivered to the Project site. Modular coils were being produced at PPPL at a rate of about one every six to seven weeks, with four modular coils having completed fabrication. Manufacture of the vacuum vessel subassemblies was completed in FY06. A contract for manufacture of the toroidal-field coils was placed and the supplier's tooling preparations were well under way by year's end.

Modular Coils

Each modular coil is wound on a tee-shaped support feature machined on the interior of a stainless steel ring-like structure called a modular coil winding form (MCWF). In the completed device, the eighteen MCWFs will be bolted together at mating flanges to form a toroidal structural shell [Figure 2(top)], which locates the windings within ± 1.5 mm of their nominal trajectories and supports them against operating loads.

The MCWFs are manufactured under a contract with Energy Industries of Ohio, Inc. (EIO), of Independence, OH. The EIO supplier team consists of C.A. Lawton Company of De Pere, WI (casting patterns), MetalTek International of Pevely, MO (castings), and Major Tool and Machine, Inc. of Indianapolis, IN (finish machining). The forms are sand cast of a custom stainless steel alloy named Stelalloy. This material was developed for NCSX to have low magnetic permeability ($\mu < 1.02 \mu_0$) and structural properties that meet or exceed performance requirements. Its good welding characteristics facilitate repair of defects that typically exist in the raw casting. Only air quenching is needed to

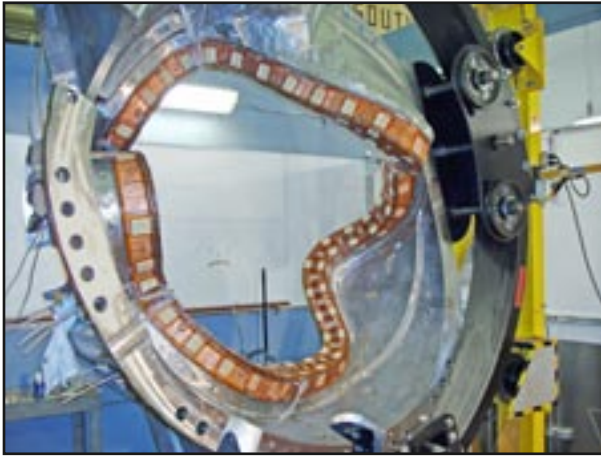

Figure 2. (top) Modular coil assembly design. (bottom) Modular coil in process.

develop the required mechanical properties, thus avoiding the risks of distortion associated with water quenching. With the shipment of the last rough casting to the machining supplier in June 2006, all foundry operations on MCWF program were completed.

The MCWF winding surfaces and flanges are machined to a tolerance of ± 0.25 mm using a series of multi-axis numerically controlled milling machines. After machining, each winding form is dimensionally inspected using a coordinate measuring machine to develop a “point cloud” which is superimposed on the winding form CAD model to identify any dimensional deviations. Development of an efficient manufacturing and inspection process, suitable for production, proved to be a significant challenge due to the highly complex geometry and tight tolerances required. The process development cycle took longer than expected, and as a result the deliveries of completed winding forms were initially very slow, threatening the Project schedule. The Project team, using a value engineering approach, carefully re-examined and relaxed some of the less critical technical requirements in light of the schedule impacts which by then were apparent. The machining supplier, Major Tool and Machine, Inc., presented a new production plan, applying additional technical and labor

resources to the MCWF program. A contract modification was negotiated, providing the supplier with financial incentives for improved schedule performance and the Project with a more favorable delivery sequence of the three MCWF types. Schedule performance improved markedly following these actions, and a reliable delivery rate of one MCWF per month was soon established. It is expected that the last winding form will be delivered around the middle of FY07.

The coils are wound onto the MCWF [Figure 2(bottom)] with a compacted copper cable conductor, 9 mm by 10 mm in cross section, whose flexibility facilitates handling and placement of its current center within ± 0.5 mm of its nominal position on the form. The conductor turns are repositioned and reshaped after winding to improve conformance to the dimensional specifications and achieve the required accuracy without the use of shims. Measurements of position errors in the completed winding pack [Figure 3(top)] demonstrate the success of the modular coil dimensional control strategy.

The completed winding pack assembly, consisting of flexible conductor, turn-to-turn insulation, and enclosing layers of ground insulation, copper cooling strips,

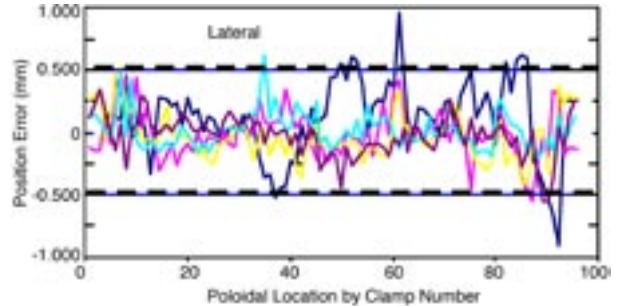

Figure 3. (top) Achieved modular coil current center position error for several coils (colored curves). (bottom) Completed modular coil.

and cooling tubes, is epoxy encapsulated to secure the dimensions and provide the required structural rigidity. Due to the complex geometry, a “bag” mold is constructed over the winding pack with layers of silicone rubber tape instead of a rigid machined mold. The mold is filled with epoxy using a vacuum-pressure impregnation process. A completed coil is shown in Figure 3(bottom).

Following manufacture, each coil undergoes electrical and pneumatic tests to verify terminal-to-terminal resistance, insulation strength, and cooling line integrity. In addition, the first coil was cooled to cryogenic temperature and subjected to several full-current pulses to verify the overall mechanical design and construction integrity. Room-temperature insulation tests on the first coil revealed a weakness in the lead area. The fault was found to be in an accessible area and was easily corrected with a design change that had no impact on performance. Only the first two coils had to be repaired to correct the fault; subsequent coils were constructed according to the new design.

Manufacture of the first modular coil was completed in March 2006, meeting an important Project milestone on schedule. Costs were significantly above estimates, however, and improving cost performance in manufacturing operations was an area of management focus throughout the year. With time and experience, the efficiency of the coil fabrication team has continually improved. A value improvement program was instituted, leading to the implementation of numerous process improvement suggestions. Coil winding cost trends were tracked at the task level to identify problem areas and guide improvement actions. By year’s end, the fabrication costs per coil had decreased to about half the cost of the first coil.

Vacuum Vessel

The NCSX vacuum vessel [Figure 4(top)] is designed to provide a vacuum boundary between the modular coils and the plasma. This results in a vacuum vessel shell geometry that approximately conforms to the plasma and which must be realized within ± 5 -mm accuracy to avoid interferences. An array of 99 ports provides ample access for diagnostics and heating systems. The vessel is fabricated of Inconel 625 alloy because of its high resistivity (to reduce eddy currents) and low magnetic permeability at weld seams.

The vessel was fabricated by Major Tool and Machine, Inc. of Indianapolis, IN. The assembly includes three identical 120-degree segments, corresponding to the three NCSX field periods. Each segment was constructed from twenty press-formed panels of ten different shapes. The panels were assembled into shell segments over



Figure 4. (top) Vacuum vessel design. (bottom) One of three field-period sectors with ports installed for vacuum testing.

accurately machined skeletal welding fixtures, which facilitated precise positioning of the panels and control of the dimensions as the panels were welded together. The ports were welded on for fit-up and vacuum testing [Figure 4(bottom)], then all except the large vertical and horizontal ports at the middle of the segment were removed and supplied separately, to be reattached by PPPL during assembly. Three custom machined 20-cm wide spacers [shown as dark blue bands in Figure 4(top)], designed to facilitate the final assembly of the device, were also supplied. Vacuum vessel manufacture, including all segments, spacers, and ports was completed in September 2006.

Toroidal-field Coils

The NCSX machine includes an array of eighteen planar toroidal-field (TF) coils to provide experimental flexibility. The inner legs, which must be positioned to an accuracy of ± 3 mm to reduce field errors, are supported by wedging. The wound coils will be epoxy

impregnated in a precisely machined mold with tolerances in the range of ± 0.25 mm in order to tightly control the geometry of the coil in the cured condition. The forward wedge supports will be cast from a low-permeability alloy.

Prior to FY06 it was planned to wind the TF coils and assemble them to procured wedge supports at PPPL. While this plan offered quality assurance advantages, cost concerns led to reexamination of the option of procuring complete assemblies (coils attached to wedge supports) from an outside supplier. A competitive procurement action was undertaken, ultimately resulting in a contract award to Everson Tesla, Inc. of Nazareth, PA. The wedge supports will be supplied by Tesla, Ltd. (United Kingdom) and Österby Gjutery (Sweden), under a subcontract to Everson, while the conductor and other coil materials were furnished by PPPL. Everson will perform the winding, impregnation, assembly, and final machining operations. Outsourcing the TF coil manufacture to a single integrating contractor results in

a streamlined acquisition plan, while Everson's proximity to PPPL facilitates quality oversight of the most critical fabrication steps. By the end of FY06, tooling preparations and material purchases were well underway in preparation for producing the first coils in FY07.

Summary

In FY06, the second year of NCSX construction, the Project's fabrication activities made a successful transition from start-up to production. The vacuum vessel contract, the Project's second largest, was completed. The largest contract, for modular coil winding form manufacture, realized a reliable production rate after overcoming some significant challenges initially. A contract for toroidal-field coil manufacture was awarded. In-house manufacturing operations also had notable successes. The first modular coil was fabricated and tested, and costs steadily came down and delivery intervals steadily improved as the year progressed. By year's end, four coils were completed.

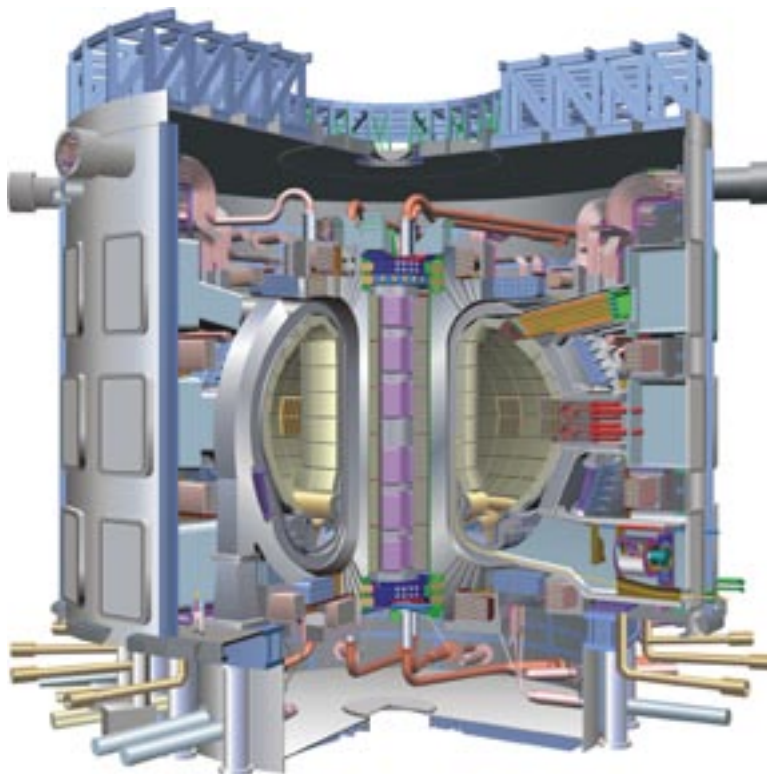

ITER

Fiscal year 2006 was, quite literally, a signature year for ITER, the international tokamak project with the goal to study the science and technology of burning plasmas. The ITER Agreement was signed at the ministerial level in June, and it laid the framework for the U.S., the European Union (EU), Japan, the Russian Federation, China, Korea, and India to work together to build and operate this device. Plans called for the top management positions to be selected by the end of calendar year 2006, and a growing international team was moving to a temporary building in Cadarache, France. Final ratification is expected in mid-2007.

Within the U.S., agreements on the management of the U.S. responsibility to provide “in-kind” hardware to the ITER Project were signed between the lead lab, Oak Ridge National Laboratory (ORNL), and PPPL, and the Savannah River National Laboratory (SRNL), as partner labs in this effort. This effort is called the U.S.

Contributions to ITER Project and is headquartered in Oak Ridge at the U.S. ITER Project Office (USIPO). The lead role shifted to ORNL to take advantage of the successful project management team available following completion of the Spallation Neutron Source Project. The ITER Project Manager, Ned Sauthoff, retired from PPPL to lead the Project as an ORNL employee.

ORNL is responsible for managing all aspects of the Project, and is directly responsible for U.S. in-kind contributions in several areas, including the building of the central solenoid, providing 8% of the toroidal-field conductor, all transmission lines for the ion cyclotron and electron cyclotron heating systems, 20% of the first wall and the two moveable port limiters, the pellet injector, the roughing pumps and standard vacuum components, and 75% of the cooling water system. As a partner lab, Savannah River is responsible for the tritium exhaust processing system. PPPL, as a partner, is managing two

primary areas, and is assisting and supporting ORNL in other areas. PPPL is responsible to provide 75% of the steady-state electric power network, and 16% of the ITER diagnostics, including five diagnostic port plugs and seven instrumentation systems.

Mid-year, PPPL researcher David Johnson became Head of PPPL's ITER Project Contributions Department, responsible for the Laboratory's ITER efforts. In October, Kathleen Lukazik joined as Department Secretary.

PPPL Roles in U.S. ITER Contributions

During FY06, through various scope-sharing agreements both internationally and within the U.S., PPPL's role in the ITER Project began to emerge. As the international ITER Project makes progress establishing and expanding their management team, there may be changes in this role. The sections below describe the status at the end of FY06.

Steady-state Electric Power Network

In March 2006, PPPL engineer Charles Neumeier was named the Steady-State Electric Power Network (SSEPN) WBS Manager (Team Leader) for the U.S. ITER Project Organization (USIPO). The SSEPN is a 130-MVA substation and distribution system, which supplies AC power to the conventional loads of ITER. The SSEPN will be designed and installed by the EU team. The role of the U.S. is to supply 75% of the equipment, except for the diesel generators and cabling, which the EU will supply 100%. All equipment will be built to IEC standards for installation in France. In the near-term, the U.S. will monitor the EU design and obtain revised cost estimates for the components.

The long-term business plan for the SSEPN is to issue a multi-phase subcontract to an engineering/construction firm to manage the procurements with Team Leader oversight. The U.S. equipment has to be delivered to the ITER site by September 2012.

Diagnostics

In March 2006, PPPL researcher David Johnson was appointed as the USIPO Diagnostics WBS Manager (Team Leader), with responsibility for providing the U.S.-allocated ITER diagnostics scope. The in-kind components are shown in Table 1, and fall into two categories — diagnostic instrumentation and diagnostic port plugs.

Figure 1 shows the ITER diagnostic port plugs (in red). These are massive structures with many functions. The upper and equatorial plugs provide support and cooling for the blanket shield modules, first-wall components at the end of the plugs facing the plasma. All three types of port plugs provide radiation shielding, protecting the magnets and supporting structure, and reducing radiation fluxes at the outside end of the plugs to a level permitting limited personnel access during maintenance periods following full power ITER operation. Finally, all of these plugs also provide the primary vacuum boundary.

During FY06, under the leadership of PPPL engineer Douglas Loesser, PPPL began an effort to develop the tools needed to lead the design and procurement of the five U.S.-allocated diagnostic port plugs. PPPL obtained and installed CATIA V5, the approved ITER CAD software. Designers received training in this software and began to use it on new workstations. In addition, PPPL enhanced its capabilities in the neutronics

Table 1. Division of U.S. ITER Diagnostic Effort between Diagnostic Instruments and Diagnostic Port Plugs.

WBS	Instrumentation Packages	Scope
1.5.3.1	Upper IR/Visible Cameras	Packages include "front-end" viewing optics, relay optics or waveguides in the ports, along with additional relay systems to bring signals to diagnostic hall, and source and detector hardware in the diagnostic hall. Some have viewing systems in ports provided by other parties. Package includes oversight of testing on ports prior to shipment to ITER.
1.5.3.2	Low-field Side Reflectometry	
1.5.3.3	Motional Stark Effect	
1.5.3.4	Electron Cyclotron Emission	
1.5.3.5	Divertor Interferometer	
1.5.3.10	Toroidal Interferometer/Polarimeter	
1.5.3.6	Residual Gas Analyzer	Several heads on pumping ducts.
WBS	Port Packages	Scope
1.5.3.7	Upper Ports (U5, U17)	Packages include design, fabrication, assembly and testing of US port plugs. Integration of the diagnostics into the ports is included in this package.
1.5.3.8	Equatorial Ports (E3, E9)	
1.5.3.9	Lower Port Structures (L8)	

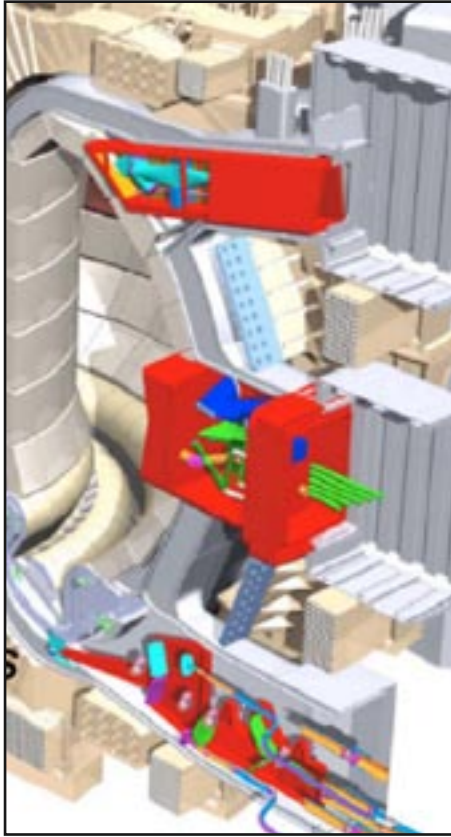

Figure 1. Cutaway CAD rendering of the ITER tokamak showing (in red) the upper, equatorial, and lower port structures. The blue and green components are the diagnostic “front-ends” housed within the plug.

area, with PPPL engineer Russell Feder receiving training in the radiation transfer code ATTILA and by his participation in efforts to benchmark the code to qualify it for use on ITER. PPPL installed a dedicated workstation for these calculations, and obtained a license from the USIPO at ORNL to run the code. The diagnostic ports’ “front-ends” will, in most cases, be labyrinths designed to provide access to the plasma while limiting the radiation streaming. ATTILA modeling of the designs will be used to assess the quality of shielding provided by particular designs.

FY06 was the first time, since the U.S. rejoined the ITER Project, that U.S. resources were available for expert design work in diagnostics. Midway through the year, the Team Leader traveled to several sites in the U.S. to discuss plans to advance the designs of the systems shown in Table 1. Within a few months, twelve “assessment studies” were launched, as shown in Table 2. As indicated in Table 2, PPPL participated in a number of these studies, which were relatively modest, typically several man-months of effort. They focused on better definition of the diagnostic

front-end configurations. In addition for some systems, alternate approaches were investigated.

Magnet Support

Throughout FY06, PPPL engineers Philip Heitzenroeder and Robert Simmons provided assistance to the USIPO to plan for the U.S. ITER magnet work. This included assistance to the ORNL Magnet WBS Manager (Team Leader) John Miller in the preparation of budgets and schedules for both the central solenoid and toroidal-field (TF) conductor contributions. As part of an expert team involving ORNL, the Massachusetts Institute of Technology, and PPPL, they participated in planning R&D to investigate more robust designs for the TF conductor.

In recent years, testing of superconducting samples built using the reference ITER design indicated that the cable quality was degrading when subjected to realistic, cyclical, electromagnetic loading. Figure 2 shows a cut-away view of the reference cable sample. The U.S. proposed to prepare conductor samples with several variants of cable braiding and also variants of the central cooling channel. In addition, PPPL engineer James Chrzanowski evaluated possible in-house capability to jacket the U.S. samples.



Figure 2. A sample end of the ITER toroidal-field conductor in conduit superconducting cables with one of the six bundles unbraided. The central perforated tube provides cryogenic cooling.

Table 2. Listing of the Diagnostic Package, the Tasks, the Performing Institutions, and the Personnel Involved with the ITER Diagnostic Assessment Studies Initiated in FY06.

Diagnostic Package	Task Summary	Institution(s)	Personnel
Upper Visible/ IR Camera	Assess Optical Design, Central Tube Concept	LLNL	C. Lasnier, M. Fenstermacher, M. Groth, L. Seppala, K. Morris, E. Synakowski
MSE	Assess usefulness of B Determination	NOVA	F. Levinton, H. Yuh, J. Foley
MSE	Performance Simulation of Conventional Polarimetry Approach	PPPL	S. Scott, B. Stratton
MSE	Optimization of Optical Design	LLNL	Steve Allen, J. Jayakumar, S. Lerner, M. Makowski, C. Holcomb, N. Wong, E. Synakowski
LFS Reflectometer	Determine Optimum Frequency Bands and Polarizations	UCLA	T. Peebles, E. Doyle, T. Rhodes, L. Schmitz, L. Zeng, S. Kubota, P. Gourdain, G. Wang
ECE	Investigate Nonthermal Issues, Use of Oblique View	PPPL	G. Taylor, P. Efthimion
ECE	Review Reference Design	U. Texas/ U. Md/MIT	M. Austin, P. Phillips, R. Ellis, A. Hubbard, Bill Rowan
Divertor Interferometer	Develop Conceptual Design	GA/UCLA	T. Carlstrom, D. Brower, Rejean Boivin, M. Von Zeeland, B. Deng, W. Ding
RGA	Develop Conceptual Design	ORNL	W. Gardner, D. Hillis
Tangential Interferometer/ Polarimeter	Optimize Reference Design	UCLA/GA	D. Brower, T. Carlstrom, M. VonZeeland, Rejean Boivin, W. Ding, B. Deng
First Mirror R&D	Model Erosion/Deposition on First Mirrors	ANL	J. Brooks, J. P. Allain, A. Hassanein, M. Nieto
Neutronics Analysis	Benchmark Neutronics Models for Plug Integration using ATTILA	UCLA/PPPL	M. Youssef, R. Feder, R. Shaefer, M. Dagher

Ion-cyclotron Heating Transmission Line Support

In a supporting role to the ORNL WBS Manager (Team Leader) David Rasmussen, PPPL researcher Joel Hosea and PPPL engineer Elmer Fredd have provided schedule, budget planning, and R&D planning for various ion-cyclotron heating components, including water-cooled lines, hybrid splitters, DC breaks, and a continuous-wave dummy load.

Secondee Support

During FY06, PPPL planning and control officer Stanford Schoen supported the USIPO by administering three U.S. ITER secondees, including the drafting of Statements of Work, Cost Proposals, and relocation contracts. Midyear, PPPL engineer Chang Jun was requested from the Central Team to support ITER vacuum vessel design and has subsequently started an assignment working at the Cadarache site in France.

PPPL Roles in Preparing for ITER Research International Tokamak Physics Activity

The International Tokamak Physics Activity (ITPA) aims at cooperation in development of the physics basis for burning tokamak plasmas. This activity, which began in 2001, has expanded in membership to include all of the ITER parties. Seven Topical Groups meet twice yearly. PPPL has broad participation in these activities. For example, within the ITPA Diagnostics Topical Group, PPPL has nine participants in various Specialist Working Groups and one Topical Group delegate.

U.S. Burning Plasma Organization

Created to coordinate U.S. efforts in burning plasma physics research, the U.S. Burning Plasma Organization (USBPO) structure was formed in 2006. PPPL researchers and engineers are in key positions within this structure, with Jonathan Menard (MHD — Macro-

scopic Plasma Physics), Cynthia Phillips (Plasma-wave Interactions), Raffi Nazikian (Energetic Particles), David Gates (Operations and Control), and Charles Kessel (Integrated Scenarios) acting as task group leaders or deputies. In preparation for the ITER Design Review, these leaders and many other PPPL participants drafted “issue cards” identifying issues for careful consideration during the Review. They will also be involved in the identification of options for issue resolution as the Review proceeds during 2007.

ITER Design Review Working Groups

As FY06 drew to a close, activity in preparation for the ITER Design Review was beginning to ramp up. Several PPPL researchers and engineers were requested to participate in various working groups, including Richard Hawryluk (Physics Objectives), Joel Hosea and Larry Grisham (Heating and Current Drive), and Charles Neumeyer (Site and Buildings).

Theory and Advanced Simulations

The Theory Department at the Princeton Plasma Physics Laboratory (PPPL) achieved all of its projected milestones and made significant progress on multiple fronts in FY06. This includes advancing the physics understanding of present experiments, preparing the knowledge base required for realistic extrapolation to burning plasma experiments such as ITER, suggesting new ideas and approaches to stimulate experimental campaigns leading to improved performance, improving computational tools that use state-of-the-art leadership class computers, and contributing to the design of diagnostics on innovative experimental devices.

The Department plays a major role in advancing fusion science through the study of a variety of topical areas. These include magnetohydrodynamics (MHD), turbulent transport, energetic particles' interaction with MHD, and boundary physics. The methods used include analytical theory and numerical codes that are applied to advancing the understanding of tokamaks, spherical torii, and stellarators. The goal is to achieve predictive capability relevant to future devices, which might be used as energy sources. In addition to the study of magnetic confinement, the Department also engages in research in heavy ion and space plasma physics.

In MHD the requirement for resistive wall mode feedback control has been identified and studied in slowly rotating plasmas. It was found that a small time delay is essential for achieving high beta, if no rotation stabilization exists. In 3-D modeling of the sawtooth instability, PPPL theorists have been able to match many features of a small tokamak and can now project the computational requirements for simulations of larger, hotter devices such as ITER. These simulations form the basis for studying more complex phenomena such as the effect on these modes of an energetic particle component or of externally generated electromagnetic radio-frequency waves.

Using the M3D Extended-MHD code (E-MHD) with up to 40 toroidal modes, large-scale edge localized mode (ELM) simulations were carried out as part of a U.S. Department of Energy (DOE) milestone goal. Nonlinear ELM simulations were also carried out in ITER geometry. Advances in developing comprehensive

MHD models were achieved using high-order finite elements with C^1 continuity. The full eight-field E-MHD code equations, including the Hall term and the full Braginskii gyroviscosity, were carried out in slab geometry. New applications such as two-fluid effects on magnetic reconnection, the gravitational instability, and the magnetothermal instability are being pursued.

Gyrokinetic toroidal codes (GTCs) have reached a stage of maturity where they can now be applied to experimental data. Global gyrokinetic simulations were carried out to study the turbulent and neoclassical transport properties for actual National Spherical Torus Experiment (NSTX) plasma discharges. General geometry GTC turbulence simulations have shown that ion temperature gradient (ITG) turbulence has significant fluctuation amplitude, but it drives insignificant ion energy transport (about neoclassical level, sometimes even below neoclassical level) in the NSTX plasmas. This result is particularly intriguing since it is in contrast to the anomalous transport observed in the DIII-D tokamak where it has been shown that ITG turbulence drives large transport (about ten times higher than the neoclassical level).

For turbulence transport, from numerical experiments with nonlinear mode coupling and/or zonal flows artificially suppressed, it is found that; (i) the linear toroidal coupling can induce convective propagation of fluctuations into the region of local linear stability; (ii) in the presence of nonlinear mode coupling, without zonal flows, the turbulence spreading is faster with temporal asymptotic behavior ranging from "convective" in the linearly unstable zone to more "diffusive" in the linearly weakly stable zone; and (iii) the principal effect of self-generated zonal flows is to reduce the intensity of fluctuations and to slow down the turbulence spreading. Spreading stops when the linear damping is strong enough. Simulations of ion temperature gradient turbulence for shaped toroidal plasmas based on DIII-D geometry have shown that turbulence spreading is quite a generic phenomenon.

In energetic-particle physics, the NOVA-K code has been upgraded to include the damping of shear Alfvén modes on the continuum. This improvement has resulted in the discovery of new types of modes, which exist

due to the coupling of different gap modes through the continuum.

In stellarator physics, the Department continues to have a direct impact on the design and construction of the National Compact Stellarator Experiment (NCSX). Relying heavily on linear algebra and especially on various singular value decomposition techniques, an extensive set of magnetic flux loops were designed and are now being mounted on the exterior surface of the NCSX vacuum vessel. In preparation for analysis of NCSX data, there is a collaboration agreement to analyze the Wendelstein-7 Advanced Stellarator (W7-AS) data. This work has led to an interesting discovery: the magnetic field line trajectories behave as if the flux surfaces are broken locally near the outboard midplane, but remain intact elsewhere, explaining the observation of finite pressure gradients in the stochastic regions. Our studies continue to elucidate the role of quasi-axisymmetry in particle confinement and have identified configurations with significantly improved confinement of energetic particles, which can be realized by taking advantage of the flexibility afforded by the trim coils.

In parallel, we continued to improve and upgrade our numerical tools. The ray-tracing algorithm was upgraded; this will help 3-D ballooning stability analysis. Improvements continued to be made to the PIES code and a helical Grad-Shafranov solver was built that can handle magnetic islands; it will be used as a test-bed for new algorithms for the PIES code.

In edge physics, the 3-D DEGAS 2 neutral transport simulations of the gas puff imaging experiments matched observations to within the estimated errors. Working with the Current Drive Experiment-Upgrade (now called the Lithium Tokamak Experiment) team, a theory of equilibrium reconstruction in the presence of 3-D eddy currents was developed. With this tool, the effect of lithium on the confinement time could be determined and enhancement factors of two to four were identified, depending on the state of the surface.

The Theory Department continued to provide strong leadership for the Plasma Science and Advanced Computing Institute (PSACI), while improving the physics fidelity and efficiently utilizing the massively parallel modern computing platforms. Key activities included organizing the Annual PSACI Program Advisory Committee (PAC) Meeting that assessed all Scientific Discovery through Advanced Computing (SciDAC) projects relevant to Fusion Energy Science (FES) and helping to develop the PAC report from this meeting. The Department helped ensure very strong FES visibility and impact at the 2006 National SciDAC Conference, including publication in the associated peer-reviewed conference proceedings, and demonstration of the ability of

the FES representative in the NERSC benchmark suite, GTC, to effectively utilize the full power of leadership class supercomputers, including the CRAY X1E and XT3 at the Oak Ridge National Laboratory, the Earth Simulator in Japan, and the Blue Gene-L at IBM's Watson Center.

Finally, it is noted that the Theory Department has a strong commitment to support theoretical studies of specific relevance to national and international experiments. The National Theory Coordinators for the spherical torus and the stellarator are members of the Department. The Theory Department also provides support for data analysis and interpretation to NSTX, NCSX, DIII-D, Alcator C-Mod, Current Drive Upgrade-Experiment (CDX-U), the Large Helical Device (LHD), the Magnetic Reconnection Experiment (MRX), the Joint European Torus (JET), JT-60U, and W7-AS.

In the following sections, examples of progress in the fusion program enabled by scientific results from the PPPL Theory Department are described.

Accomplishments

The following milestones for Theory of Tokamaks and Alternates, Advanced Computing, and SciDACs were successfully met on-time:

- Evaluated the continuum damping stabilization effect and the effect of the separatrix on $n = 1-10$ Alfvén eigenmodes stability in ITER.
- Performed nonlinear hybrid simulations of beam-driven MHD modes in NSTX and related them to experimental results.
- Calculated efficacy of the proposed NCSX trim coils.
- Organized the Annual PSACI PAC meeting and coordinate the PAC report on progress of all FES SciDAC projects. (Advanced Scientific Computing)
- Developed a publication based on the nonlinear behavior of the $m = 1$ mode in CDX-U. [Center for Extended MHD Modeling (CEMM)]
- Submitted a paper on particle noise and convergence studies in long-time turbulence simulation of ion-temperature Gradient (ITG) modes. [Gyrokinetic Particle Simulation (GPS)]
- Developed a detailed work plan for the five-year Center for Simulation of RF Wave Interactions with Magnetohydrodynamics (CSWIM) project, assigned responsibilities, and documented existing modules.

- Demonstrated file-based coupling of XGC and M3D codes. [Center for Plasma Edge Simulation (CPES)]
- Completed the implementation of field-line resonance dielectric tensor elements for species with arbitrary velocity distribution functions in the TORIC code. This work represents collaboration with the MIT Plasma Science and Fusion Center. (Radio-frequency SciDAC)
- Deployed Parallel NUBEAM as a FusionGrid Computational Service. (Fusion Collaboratory)

Analytic Theory

A review paper entitled “Foundations of Nonlinear Gyrokinetic Theory,” co-authored by A.J. Brizard (St. Michael’s College) and T.S. Hahm (PPPL), was accepted for publication in *Reviews of Modern Physics*. In this 50-page paper, the foundations of nonlinear gyrokinetic theory are reviewed with an emphasis on the rigorous applications of Lagrangian and Hamiltonian methods used in the variational derivation of nonlinear gyrokinetic Vlasov-Maxwell’s equations. The physical motivations and applications of the nonlinear gyrokinetic equations, which describe the turbulent evolution of low-frequency electromagnetic fluctuations in nonuniform magnetized plasmas with arbitrary magnetic geometry, are also discussed. The paper describes the analytic theoretical progress made by many members of the PPPL Theory Department since the early 1980s, when nonlinear gyrokinetic theory was invented.

Recently the underlying mathematical structure of modern gyrokinetic theory has been further elucidated by noting the crucial role of gyrosymmetry in allowing decoupling of the fast time scale gyration from slower time scale gyrocenter motion. Starting from the single-particle Poincaré-Cartan-Einstein form in the 7-D phase space (a generalization of Lagrangian), the infinitesimal generator of gyrosymmetry is then constructed by applying the Lie perturbation method. This work is being extended to edge plasmas.

PPPL Theoretical Extended MHD Division and CEMM

Feedback control of resistive wall modes in slowly rotating DIII-D plasmas. In slowly rotating plasmas on DIII-D, the requirements for resistive wall mode (RWM) control feedback were identified using an MHD code along with measured power supply characteristics. It was found that a small time-delay is essential for achieving high beta if no rotation stabilization exists. The overall system delay or the band pass time constant

should be in the range of 0.4 of the RWM growth time. Recently the control system was upgraded using 12 linear audio amplifiers and a faster digital control system, reducing the time-delay from 600 to 100 μ s. The advantage has been clearly observed when the RWMs excited by edge-localized modes were effectively controlled by feedback, even if the rotation transiently slowed nearly to zero. This study provided insight on stability in the low-rotation plasmas with balanced neutral-beam injection in DIII-D and also in ITER.

Three-dimensional modeling of the sawtooth instability in a small tokamak. The sawtooth instability is the most fundamental dynamic of an inductive tokamak plasma discharge such as will occur in ITER. Sawtooth behavior is complex and remains incompletely explained. While the instability is confined to the center of the plasma in low-pressure, low-current, large-aspect-ratio discharges, under certain conditions it can create magnetic islands at the outer resonant surfaces and may set off a sequence of events that leads to a major disruption. Under some circumstances the reconnection following the sawtooth is observed to be complete; in others, it is incomplete. As part of the CEMM SciDAC project, an ambitious campaign was undertaken to model this periodic motion as accurately as possible using the most complete fluid-like description of the plasma, the Extended-MHD model. Both the NIMROD and the M3D codes have been applied to this problem, which is also a nontrivial test comparing these two codes far into the nonlinear regime. Compared to the MHD model, Extended MHD predicts plasma rotation, faster reconnection, and reduced field-line stochasticity in the crash aftermath. The multiple time scales associated with the reconnection layer and growth time make this an extremely challenging computational problem.

A recent M3D simulation used more than 500,000 elements for 400,000 partially implicit time steps, and there still remain some resolution issues. However these calculations are providing insight into the nonlinear mechanisms of surface breakup and healing. PPPL theorists have been able to match many features of a small tokamak and can now project to the computational requirements for simulations of larger, hotter devices such as ITER. These simulations form the basis for studying more complex phenomena such as the effect on these modes of an energetic-particle component, or of externally generated electromagnetic radio-frequency waves.

ELM simulations with M3D. Large-scale edge-localized mode (ELM) simulations using the M3D extended MHD code with up to 40 toroidal modes were carried out as part of a DOE milestone. Simulations were done starting from DIII-D EFIT equilibria. Nonlinear computations were performed both with and without

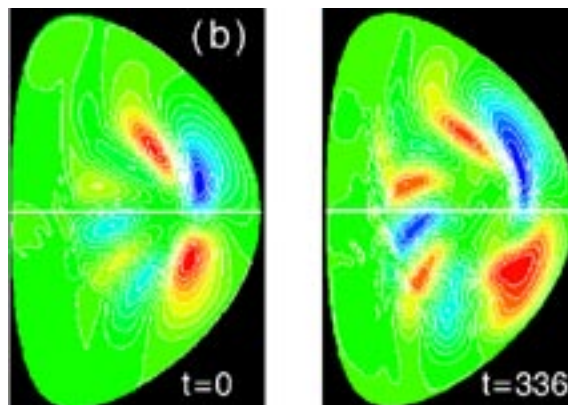
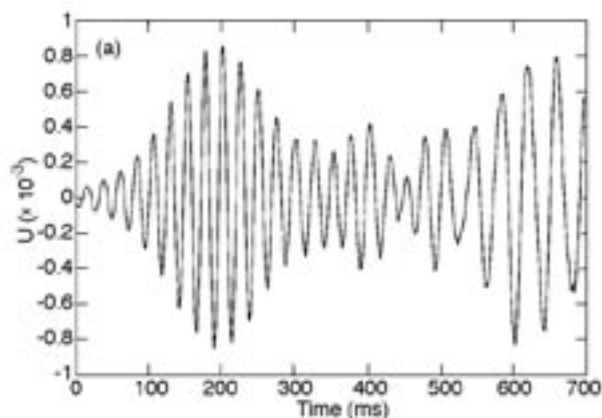

(a) Beam-driven modes in NSTX exhibit nonlinear frequency chirping. (b) Mode structure evolution, $t = 0$ on the left, $t = 336$ on the right. This time slice is shown as the broken line in (a).

gyroviscous stabilization. Gyroviscosity had little effect on the nonlinear ELM behavior, which is dominated by moderate toroidal modes. Nonlinear ELM simulations were also carried out in ITER geometry. In the ITER simulations, substantial outflow of density to the diverter was observed. Upwind numerical methods were introduced in M3D to deal with nonlinear advection of the pedestal density. Mesh generation was improved to deal with a realistic boundary shape. Simulations were also done in which the bootstrap current, pressure pedestal, and density pedestal were calculated with the XGC kinetic neoclassical edge code. The effects on ELMs of varying the bootstrap current and pressure profiles were studied. The near-vacuum region surrounding the plasma is modeled as a high resistivity, low-density plasma, bounded by a rigid conducting wall at the vacuum vessel. Good initial equilibria and high spatial resolution in the affected region were found to be essential for accurate modeling. The linear spectrum of modes was studied and convergence was accelerated by first enforcing toroidal periodicity at a given mode number n , then increasing the number of poloidal planes and independently decreasing the periodicity, finally feeding into the full simulation.

An implicit method for magnetic fusion MHD calculations using adaptive, high-order, high-continuity finite elements. Many aspects of the physics of toroidal magnetic fusion experiments can be described by a set of Extended Magnetohydrodynamic (E-MHD) equations for the evolution of the fluid-like quantities describing the high-temperature plasma and the magnetic field. Because of the multiplicity of time and space scales that develop, it is now recognized that adaptive higher-order finite elements with an implicit time integration scheme offer significant advantages. Significant progress was made in solving these E-MHD equations using high-order finite elements with C^1 continuity.

These lead to a compact representation which is compatible with an efficient solution algorithm. The method builds on formalism for representing the velocity in a potential/stream-function form, and the magnetic field in an intrinsically divergence-free form that is used in M3D. The full eight-field E-MHD equations, including the Hall term and the full Braginskii Gyroviscosity, have been implemented in slab geometry. New applications on two-fluid effects on magnetic reconnection, the gravitational instability, and the magnetothermal instability were pursued. New results include documented resolution requirements in the case of no-guide field reconnection and a study of the effect of a guide magnetic field on the onset of fast magnetic reconnection was started.

Energetic Particle Physics

Nonlinear simulations of fishbone instability in tokamaks and spherical torii. New results of self-consistent nonlinear simulations of the fishbone instability using the extended MHD code M3D were obtained. Hybrid simulations of the energetic particle-driven fishbone instability in a circular tokamak show dynamic mode saturation as the particle distribution is flattened and mode frequency is reduced strongly. MHD nonlinearity reduces the mode saturation level. The results for the nonlinear fishbone is qualitatively similar to the hole-clump theory of the bump-in-tail instability. In particular, the nonlinear frequency evolution approximately scales as $\delta f \sim \tau^{1/2}$, as found analytically by the theory. Of course, quantitative agreement is not expected since our model is much more comprehensive and self-consistent.

Continuum damping model in NOVA-K code and its validation against C-Mod experiments of external medium- to high- n TAE excitation. The NOVA-K code has been upgraded to include the damping of shear

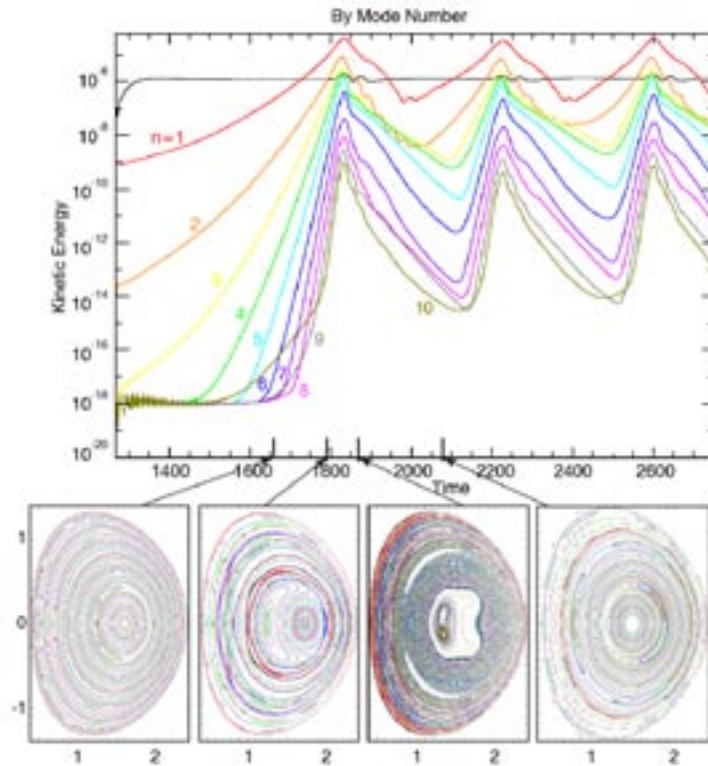

M3D simulations of CDX-U plasma showing repetitive sawtooth cycles with periods dominated by stochastic field lines.

Alfvén modes on the continuum. The numerical procedure is based on the perturbative approach suggested by H. Berk in application for toroidal Alfvén eigenmode (TAE) stability. Such improvement has already resulted in the discovery of new types of modes, which exist due to the coupling of different gap modes through the continuum. To validate the continuum mechanism, a set of special experiments on C-Mod was analyzed in collaboration with J. Snipes (MIT) in which external antennas were used to drive stable TAEs with moderate toroidal mode numbers up to $n = 10$. Measured damping rates were compared against predictions of several damping mechanisms implemented in NOVA-K. The dominant simulated damping mechanism turns out to be the continuum damping, and its absolute value, varying typically from 0.3 to 3%, is found in good agreement with the experimental data. It is important to note that the same range of toroidal mode numbers is expected to be excited in ITER.

High-frequency instability in NSTX. For the first time the spectrum of compressional Alfvén eigenmodes (CAE) was modeled with the global ideal-MHD code (NOVA), which showed that within the ideal-MHD, one can simulate their mode structure and spectrum. The CAE spectrum is characterized by three quantum (or mode) numbers: radial, poloidal, and toroidal. The

same kind of modes are responsible for the ion cyclotron emission observed earlier in tokamaks. It is speculated that such modes could be observed in ITER at integer harmonics of the fundamental cyclotron frequency and is suggested to be the tool for an alpha particle diagnostic.

The mode that chirps in frequency on a few milliseconds time scale and that has characteristics compatible with the compressional Alfvén wave (or perhaps a global Alfvén wave) was analyzed separately. The destabilizing resonance is attributed to anisotropy in the injected energetic neutral-beam exciting the CAE through the ion-cyclotron resonance of Doppler-shifted fast particles. It is speculated that beam ions interacting with CAEs in NSTX lead to the formation of coherent phase space structures with the frequency changing as a square root in time. Theory applied to such structure in NSTX allows inference of the growth rate of the instability, which turns out to be similar to the predictions of the linear instability theory.

New beam-driven modes below the geodesic acoustic frequency in NSTX. Global MHD eigenmode solutions are found associated with the gap in the Alfvén/acoustic continuum. The modes are at frequencies below the geodesic acoustic modes (GAM). In contrast to the mostly electrostatic polarization of GAMs, the

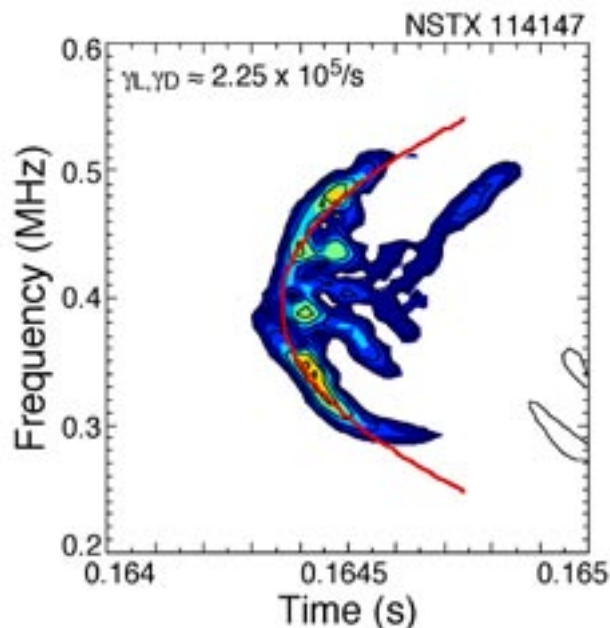

Mirnov signal measured near the plasma edge in NSTX. The observed “Angel fish” like frequency sweeping, red curve, implies the existence of coherent structures, and particle trapping in phase space.

new modes contain an electromagnetic component due to the interaction with the Alfvén branch. Indeed, a new continuum branch emerges with a modified shear Alfvén wave dispersion relation. The new modes associated with this shear Alfvén branch have phase velocity significantly above the background ion thermal velocity and thus are expected to be insensitive to kinetic effects. These new modes may be associated with so-called beam Alfvén eigenmode (BAE) modes that have been found (but not explained theoretically) in numerical MHD codes and kinetic codes. It is shown that new

modes agree with the observations in NSTX at roughly half of the TAE frequency and have similar polarization.

Turbulent Transport Simulations

Recent simulations using general geometry GTC for shaped plasmas. In the NSTX, the energy loss rate in the ion channel is often close to the neoclassical level. To verify this finding, global gyrokinetic simulations were carried out to study the turbulent and neoclassical transport properties for actual NSTX discharges. General geometry GTC turbulence simulations showed that ion-temperature-gradient (ITG) turbulence has significant fluctuation amplitude, but it drives insignificant ion energy transport (about neoclassical level, sometimes even below neoclassical level) in the NSTX plasmas. This distinguished feature is particularly intriguing since it is in contrast to the anomalous transport observed in DIII-D where it has been shown that ITG turbulence drives large transport (about ten times higher than the neoclassical level). In the mean time, the turbulence fluctuation levels for the two machines are actually comparable ($e\Phi/T_i < 1\%$). It is also found that self-consistent equilibrium $E \times B$ flows, which are determined by neoclassical dynamics and calculated by the GTC-Neo global particle-in-cell (PIC) simulation, can strongly stabilize ITG modes. Ion-ion collisions are shown to enhance ITG-driven thermal transport, but not significantly. In some NSTX H-mode (high-confinement mode) discharges, ITG is shown to be stable even without equilibrium $E \times B$ flows.

Gyrokinetic studies of nonlocal properties of turbulence-driven transport. For turbulence transport, from numerical experiments with nonlinear mode coupling and/or zonal flows artificially suppressed, it is found that: (i) the linear toroidal coupling can induce convec-

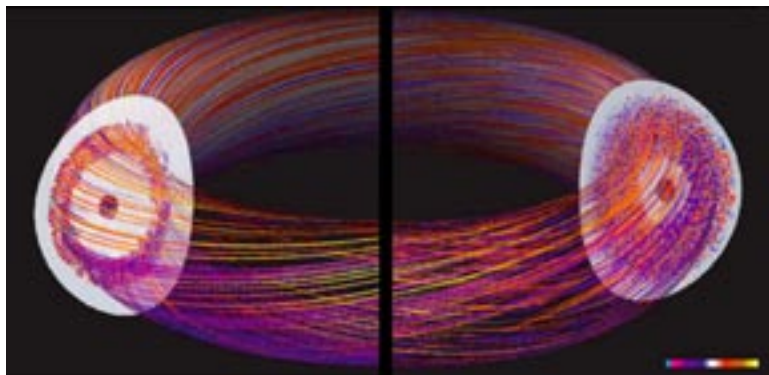

Turbulence spreading of the perturbed potentials due to ion-temperature-gradient (ITG) drift modes in the radial direction from an earlier time (left) to a later time (right) as they following the field lines in the toroidal direction in a shaped tokamak plasma. The simulation was carried out using GTC-S and the visualization was done by S. Klasky, Oak Ridge National Laboratory.

tive propagation of fluctuations into the region of local linear stability; (ii) in the presence of nonlinear mode coupling, without zonal flows, the turbulence spreading is faster with temporal asymptotic behavior ranging from “convective” in the linearly unstable zone, to more “diffusive” in the linearly weakly stable zone; and (iii) the principal effect of self-generated zonal flows is to reduce the intensity of fluctuations and to slow down the turbulence spreading. Spreading stops when the linear damping is strong enough. Simulations of ITG turbulence for shaped toroidal plasmas based on DIII-D geometry have shown that turbulence spreading is quite a generic phenomenon. Our studies have focused on the turbulence spreading through a transport barrier characterized by an $E \times B$ shear layer. By placing a radial electric field well, with varying strength, next to the region where the ITG instability is linearly unstable, it was found that the shear layer with an experimentally relevant level of the shearing rate can significantly reduce, and sometimes even block, turbulence spreading by reducing the spreading extent and speed. Studies with more realistic radial electric field profiles are in progress alongside the development of an analytic model.

Nonlocal neoclassical transport in tokamak and spherical torus experiments. Large ion orbits can produce nonlocal neoclassical effects on ion-heat transport, the ambipolar radial electric field, and the bootstrap current in realistic toroidal plasmas. Using a global Delta-f particle simulation, it is found that the conventional local, linear gradient-flux relation is broken for the ion thermal transport near the magnetic axis. With regard to the transport level, it is found that details of the ion temperature profile determine whether the transport is higher or lower when compared with the predictions of standard neoclassical theory. Particularly, this nonlocal feature is suggested to exist in NSTX, being consistent with experimental evidence. It is also shown that a large ion temperature gradient can increase the bootstrap current. When the plasma rotation is taken into account, the toroidal rotation gradient can drive an additional parallel flow for the ions and then additional bootstrap current, either positive or negative, depending on the gradient direction. Compared with the carbon radial force balance estimate for the neoclassical poloidal flow, the nonlocal simulation predicts a significantly deeper radial electric field well at the location of an internal transport barrier of an NSTX plasma discharge.

Gyrokinetic simulation of global turbulent transport properties in tokamak experiments. A general geometry gyrokinetic model for particle simulation of plasma turbulence in tokamak experiments has been developed incorporating the comprehensive influence of noncircular cross section, realistic plasma profiles, plas-

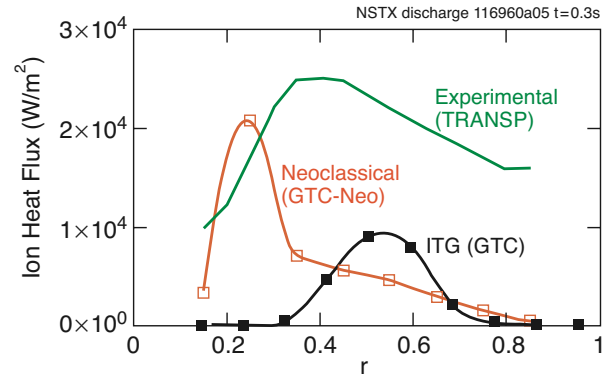

Comparison of the experimental data with those from ITG turbulent and neoclassical simulations using the GTC codes by W.X. Wang.

ma rotation, neoclassical equilibrium electric fields, and Coulomb collisions. An interesting result of global turbulence development in a shaped tokamak plasma relates to nonlinear turbulence spreading into the linearly stable region. The mutual interaction between turbulence and zonal flows in collisionless plasmas was studied with a focus on identifying possible nonlinear saturation mechanisms for zonal flows. A bursting temporal behavior with a period longer than the geodesic acoustic oscillation period is observed even in a collisionless system. The simulation results suggest that the zonal flows can drive turbulence. However, this process is too weak to be an effective zonal flow saturation mechanism.

Global particle-in-cell simulations of microturbulence with kinetic electrons. The effects of nonadiabatic electrons on ITG drift instabilities were studied in global toroidal geometry using the gyrokinetic particle simulation approach. It was found that the cross-field ion heat transport is two to three times larger in the presence of trapped electrons as compared to the purely adiabatic electron case, and that the zonal component of the electrostatic potential has shorter wavelength. The numerical methods for calculating both the adiabatic and the nonadiabatic responses for the electrons were included in the study.

Gyrokinetic Particle Simulation of Fusion Plasmas: Path to Petascale Computing

Gyrokinetic particle simulation of fusion plasmas for studying turbulent transport on state-of-the-art computers has a long history of important scientific discoveries. The primary examples are: (i) the identification of ITG drift turbulence as the most plausible process responsible for the thermal transport observed in tokamak experiments, (ii) the reduction of such transport due to the presence of zonal flows, and (iii) the confinement

scaling trends associated with size of the plasma and also with the ionic isotope species. With the availability of terascale computers in recent years, simulations with improved physics fidelity using experimentally relevant parameters also have been carried out. Computationally, it has been demonstrated that the lead PIC code, the Gyrokinetic Turbulence Code (GTC), is portable, efficient, and scalable on various massively parallel processor platforms. Convergence studies with unprecedented phase-space resolution have also been carried out. Since petascale resources are expected to be available in the near future, better physics models and more efficient numerical algorithms to take advantage of this exciting opportunity are being developed. For the near term, interest is on understanding some basic physics issues related to ITER burning plasmas experiments. The long range goal is to carry out integrated simulations for ITER plasmas for a wide range of temporal and spatial scales, including high-frequency short-wavelength wave heating, low-frequency mesoscale transport, and low-frequency large-scale magnetohydrodynamic (MHD) physics on these computers.

Fluctuations and Discrete Particle Noise in Gyrokinetic Simulation of Drift Waves

The relevance of the gyrokinetic fluctuation-dissipation theorem (FDT) to thermal equilibrium and non-equilibrium states of the gyrokinetic plasma has been explored, with particular focus given to the contribution of weakly damped normal modes to the fluctuation spectrum. It is found that the fluctuation energy carried in the normal modes exhibits the proper scaling with particle count (as predicted by the FDT in thermal equilibrium), even in the presence of drift waves, which grow linearly and attain a nonlinearly saturated steady-state. This favorable scaling is preserved, and the saturation amplitude of the drift wave unaffected, for parameter regimes in which the normal modes become strongly damped and introduce a broad spectrum of discreteness-induced background noise in frequency space. The relationship of the present work to the more general issue of discrete particle noise in PIC simulations has been studied.

High-frequency Gyrokinetic Particle Simulation

As demonstrated earlier within the gyrocenter-gauge kinetic theory, the linear gyrokinetic formulation for $\rho/L \ll 1$ can be generalized to describe the arbitrary frequency and wavelength dynamics, where ρ is the ion gyroradius and L is the scale length of the ambient magnetic field. A high-frequency gyrokinetic algorithm based on this theory, which utilizes the separation of the ion gyromotion from its gyrocenter motion and is

equivalent to the original Lorentz-force description for $\rho/L \ll 1$, was studied. Using a simple 2-D electrostatic collisionless system, an extended nonlinear Delta-f gyrokinetic particle-in-cell simulation of the model was performed to demonstrate its ability to study arbitrary frequency dynamics. Simulations of cyclotron wave and nonlinear ion-heating dynamics were performed using both conventional Lorentz-force code and the new code. The numerical properties of the new formulation resulting from the separation of time scales between gyromotion and gyrocenter motion were studied. The new algorithm may be generalized for electromagnetic systems in general geometries. The ultimate purpose is to implement this new technique to global gyrokinetic simulation of fusion devices to study the dynamics of radio-frequency waves in realistic plasmas and their effects on plasma stability and transport.

Long-time Simulations of Microturbulence in Fusion Plasmas

Recent long-time microturbulence simulations of fusion plasmas using gyrokinetic particle codes on massively parallel computers with billions of particles have contributed to fundamental physics understanding, but have also attracted concern about the numerical convergence issue, i.e., whether these codes suffer from discrete particle noise due to the use of a large, but finite, number of particles. In studies during FY06, it was determined, both numerically and analytically, that numerical noise is not a cause for concern in long-time simulations.

Electromagnetics

During FY06 the critical interface to the Gyrokinetic ElectroMagnetic (flux-tube and wedge geometry) PIC code developed at the University of Colorado to deal with experimental input data was developed and implemented. Preliminary analysis of ETG and ITG modes at beta of 16% is underway.

Stellarator Theory

Significant progress was made in the past year on the following stellarator theory projects.

Improved design method for magnetic diagnostics. In collaboration with E. Lazarus (Oak Ridge National Laboratory), M. Zarnstorff, A. Boozer (Columbia University), and A. Brooks, and relying heavily on linear algebra and especially on various singular value decomposition techniques, an extensive set of magnetic flux loops were designed for the exterior surface of the NCSX vacuum vessel. The goal was to find an arrangement of loops that can differentiate between measurable magnetic field patterns at the vessel. For identification of stellarator-

symmetric fields, the flux loops provide the equivalent of complete coverage of one half-period of the vessel. To optimize the analysis capability of non stellarator-symmetric magnetic fields, it was found that distributing loops irregularly over all six half-periods of the NCSX vessel torus was superior to more traditional arrayed distributions of loops. The installation process was begun in the fall of 2006.

Loss of flux surfaces with increasing beta in the W7-AS stellarator. During FY06, in a collaboration with M. Zarnstorff, A. Weller, J. Geiger, and the W7-AS Team (Germany), an improved model for equilibrium in the stochastic region was developed, applying resonance-broadening theory, taking advantage of a mathematical equivalence between the equation for the Pfirsch-Schlüter current in the presence of chaotic magnetic field line trajectories and the collisionless Vlasov equation in the presence of electrostatic turbulence. A more quantitative comparison with the experimental observations has been made, with a calculation of the heat transport due to stochasticity, finding that its magnitude is consistent with the finite pressure gradients observed in the stochastic region in the experiment. This work has also led to an interesting discovery that the magnetic field line trajectories behave as if the flux surfaces are broken locally near the outboard midplane, but remain intact elsewhere.

Improvement of confinement of energetic particles in NCSX. In collaboration with L. Ku, E. Lazarus (Oak Ridge National Laboratory), and A. Boozer (Columbia University), a theoretical study of a new class of qua-

si-axisymmetric stellarators with improved confinement relative to previously studied configurations has illuminated the physics behind this discovery. It is found that non-quasisymmetric ripple is particularly deleterious on some portions of a flux surface, and relatively benign in other regions. This theoretical understanding has been used to construct an improved objective function for optimization of realizable configurations in NCSX, and has led to a demonstration that configurations with significantly improved confinement of energetic particles can be realized by taking advantage of the flexibility afforded by the trim coils.

Improved ballooning ray-tracing algorithm. A code for studying ballooning mode second-stability properties was extensively applied to experimental observations, in collaboration with the Large Helical Device (LHD) and W7-AS stellarator groups, and this work is continuing. Ray-tracing methods will be used to make contact between the local ballooning analysis and global stability calculations. For this purpose, a semi-analytical method for constructing the derivatives of the ballooning eigenvalue, based on operator perturbation theory, has been implemented and published. This will allow for more efficient ray tracing, important for three-dimensional ballooning.

PIES code verification and improvement. In collaboration with R. Samtaney, a new helical Grad-Shafranov solver that can handle magnetic islands was developed. It is being used to benchmark the PIES code (PIES has a switch that allows it to handle helically symmetric configurations) as a test-bed for new algorithms for the PIES

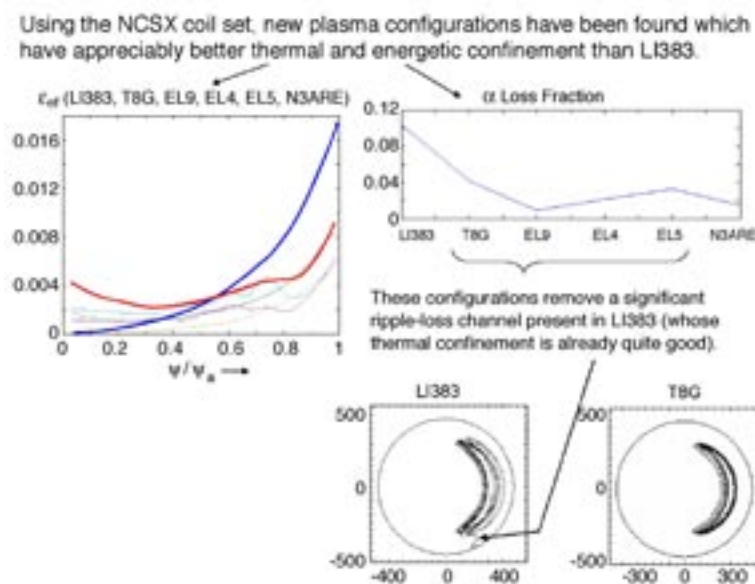

Access to improved confinement in NCSX. (From H. Mynick, A. Boozer, L.-P. Ku, and E. Lazarus, 2006 American Physical Society Division of Plasma Physics Meeting.)

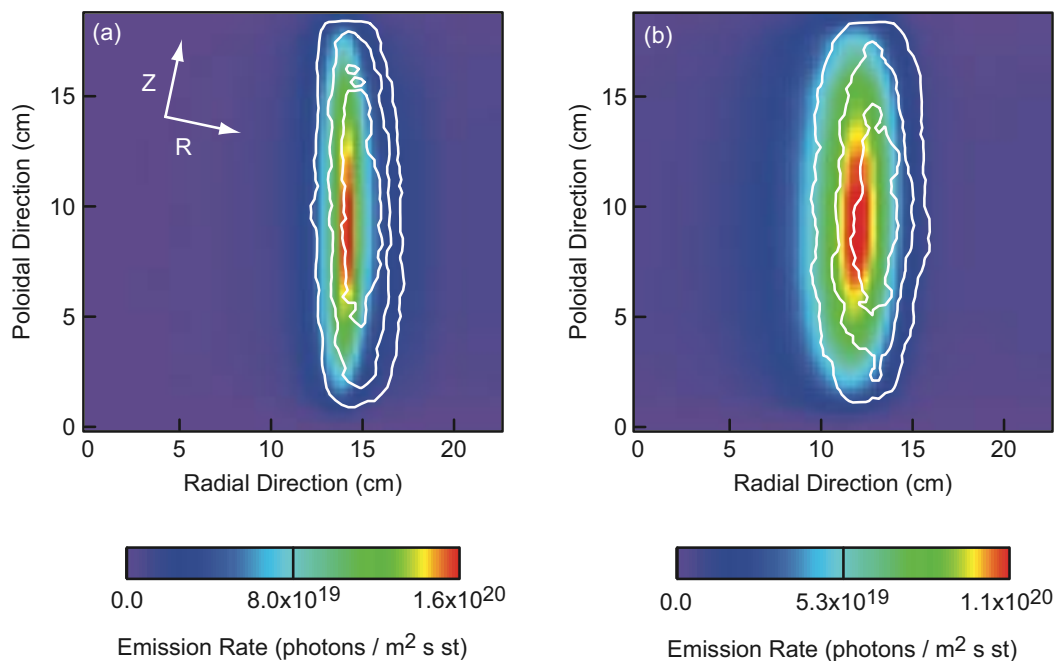

DEGAS 2 neutral transport simulations (color images) of NSTX gas puff imaging experimental data (line contours) are compared for shots 112811 (a) and 112814 (b). Experimental data input to DEGAS 2 provide the plasma background. The code simulates the 3-D transport of helium atoms puffed into the edge of the plasma and records their light emission with an emulation of the fast camera used on NSTX. The contours representing the experimental data are a time average of the 300 frames recorded by the camera, facilitating the comparison with the steady-state DEGAS 2 simulation. The arrows in (a) indicate the directions of increasing major radius R and height above mid-plane Z.

code, and for testing and verification of a new capability being incorporated in the PIES code to handle neoclassical effects on magnetic islands. A Jacobian-free Newton-Krylov method, coupled to a line-solver for globalization, is currently being tested as a potential method for speeding the calculation of 3-D equilibria with magnetic islands.

Radio-frequency Modeling

The finite Larmor radius, ion-cyclotron radio-frequency wave propagation code TORIC has been generalized to allow the prescription of arbitrary distribution functions of the form, $f(v_{\parallel}, v_{\perp})$, at each point on a poloidal cross section, (θ, ψ) , in the computation of the hot plasma dielectric tensor. Previously the function was restricted to a Maxwellian shape, constant on a flux surface. This advance will enable more realistic computations of heating and current drive in toroidal plasmas to be performed, since the injection of energy via beams and radio-frequency often leads to significant modifications of the distribution function. E. Valeo and C. Phillips per-

formed this work as part of PPPL's contribution to the Radio-frequency SciDAC Project, with support from the PPPL Advanced Scientific Computing initiative.

Edge Physics

In a paper presented at the 17th International Conference on Plasma Surface Interactions, Daren Stotler examined the temporal behavior of helium atoms used as the emitting species for gas puff imaging (GPI) experiments on NSTX and showed that for the time scales of interest (longer than 1 microsecond), the atomic physics model underlying the conventional interpretation of gas puff imaging is valid. The 3-D DEGAS 2 neutral transport simulations of these experiments matched observations to within the estimated errors. Working with the CDX-U experimental team, a theory of equilibrium reconstruction in the presence of 3-D eddy currents was developed. Analysis finally revealed the effect of lithium plasma facing surface on the confinement time. Enhancements by factors of 2 to 4 were identified, depending on the state of the surface.

Computational Plasma Physics

The mission of the Computational Plasma Physics Group at the Princeton Plasma Physics Laboratory (PPPL) is to advance and disseminate modern computational methods throughout PPPL and the fusion community and to use these methods to improve the calculation of critical experimental and theoretical program elements. Areas of activity include transport analysis and FusionGrid, applications of the adaptive mesh refinement techniques in three dimensions, the use of high-order discretizations, advanced data transfer and visualization, and optimization techniques for parallel-vector computers.

Scaling 3-D MHD Codes to Large Numbers of Processors

The M3D code is used for simulating global instabilities in magnetic fusion device plasmas. It is one of the two major codes in use by the Scientific Discovery through Advanced Computing (SciDAC) Center for Extended Magnetohydrodynamic Modeling (see <http://w3.pppl.gov/cemm>). The partially implicit algorithms in the code are known to be a challenge to implement efficiently on massively parallel computers. However, in FY06 considerable progress was made in improving the parallel scaling properties of the M3D code. This was accomplished primarily by switching to an optimized multi-grid Poisson solver developed by our SciDAC collaborators and by improving the algorithm for distributing the mesh points over the processors. In addition, some inefficiency was eliminated in the inter-processor communications that set in when operating at more than 1,000 processors. M3D now exhibits essentially perfect weak toroidal scaling on the National Energy Research Supercomputer Center (NERSC) IBM SP3 computer (Seaborg) up to 2,048 processors. (Weak scaling implies that the problem size grows as the number of processor grows, allowing larger and more highly resolved applications to be run). The code also exhibits favorable scaling on the Oak Ridge National Laboratory (ORNL) SP4 computer (Jaguar) up to the whole machine size, 10,240 processors.

It can be seen from Figure 1 that M3D scales nearly linearly with processor number up to several thousand

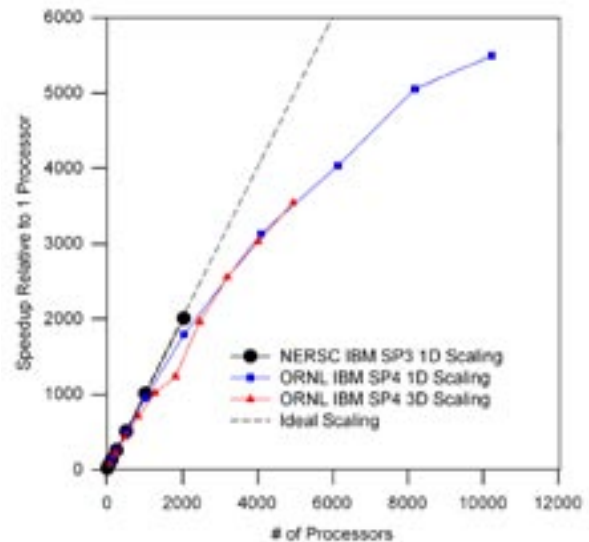

Figure 1. Speedup relative to one processor for the M3D code on the Massively Parallel NERSC and ORNL computers. Both 1-D scaling, where the number of toroidal planes grows with processor number, and 3-D scaling, where the number of mesh points within a toroidal plane also grows with processor number are used.

processors, and continues to exhibit increasing speedup up to the whole machine size. These studies used both 1-D scaling, where the number of toroidal planes increased with the number of processors, and 3-D scaling, where both the number of toroidal planes and the number of grid points within a toroidal plane increase with processor number. Favorable strong scaling also has been demonstrated (where the problem size stays fixed as the number of processors increases) on up to 5,000 processors on the ORNL computers with a parallel efficiency of more than 70%. In addition, favorable scaling up to 1,024 processors on the Argonne BGL computer has been obtained and this continues to be extended as resources permit.

Parallel Scaling Studies with GTC Code

The Gyrokinetic Toroidal Code (GTC) has been ported and optimized on the large Cray XT computer at the National Center for Computational Sciences

(NCCS), located at ORNL. This system is on the path to achieve petascale performance by 2008, and GTC is among the few scientific applications that will be ready to take full advantage of the final massively parallel configuration. In September 2006, the Computational Plasma Physics Group (CPPG) succeeded in running the GTC code on 10,386 processor cores on the NCCS Cray XT3, which was the highest concurrency of the system at the time. The code was able to advance 5.4 billion particles per step per second, a 13% percent improvement over our previous record of 4.8 billion particles per second achieved on the Japanese Earth Simulator computer. This accomplishment was highlighted in the HPCwire newsletter (see <http://www.hpcwire.com/hpc/943289.html>).

With the new capabilities and resources made possible by the NCCS Cray XT, an extensive study of electron temperature gradient turbulence was carried out by routinely running large, high-resolution GTC simulations on 6,400 processor cores with up to 40 billion particles. This work is part of the SciDAC Center for Gyrokinetic Particle Simulation of Turbulent Transport in Burning Plasmas.

A winning proposal submitted to the IBM/Blue Gene Consortium gave the CPPG the opportunity to run GTC on the large Blue Gene/L computer at the IBM T.J. Watson Research Center in Yorktown Heights, NY. The project was aimed at studying the effect of collisions on steady-state turbulent transport using high phase space resolution simulations. Optimizations such as hand-coded vectorization and processor placement were used to maximize the performance of GTC on Blue Gene/L. A full 12,000-time-step production simulation was carried out on 32,768 processor cores, the largest queue on the system, in only 3.2 hours using 1,024 particles per cell. This is shown and compared with previous runs in Figure 2. This calculation demonstrated the outstanding load balance of the GTC parallel algorithm and its readiness for petascale computing. It was also observed that GTC makes very efficient use of the second core on each Blue Gene/L node, as is the case on the Cray XT3 nodes. This will become even more important as the number of cores per node continues to increase on the high-performance computing systems.

Nonlinear Benchmarking of MHD and Extended-MHD Codes

As part of the CPPG activities within the SciDAC Center for Extended MHD Modeling (CEMM), several nonlinear benchmarking studies have been done that involve five MHD and Extended-MHD codes used in the fusion community. Two of these, the JFNK-FD and M3D-C¹ codes, are under active development with-

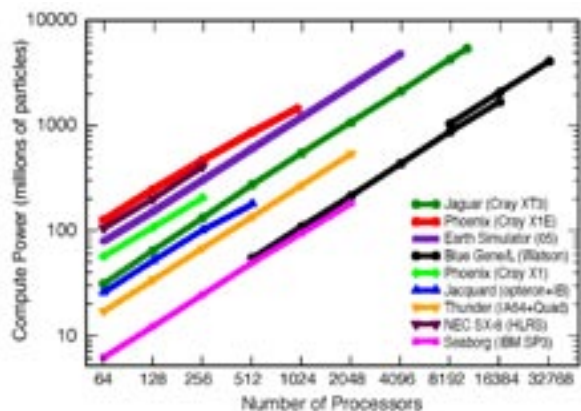

Figure 2. Compute power of the Gyrokinetic Toroidal Code (GTC) for nine large-scale computing systems. The highest concurrency was achieved on the Blue Gene/L computer at the IBM T.J. Watson Research Center using 32,768 processor cores. However, the highest performance of 5.4 billion particles pushed per step per second was obtained on the Cray XT3 computer at NCCS/ORNL using 10,386 processor cores, breaking the previous record of 4.8 billion particles achieved on the Japanese Earth Simulator.

in the CPPG at PPPL. Benchmarking is considered to be an essential part of the code-development process as there are little or no analytic results to compare with in the nonlinear regimes. The benchmarks presented here are based on a well-defined 2-D test problem known as the GEM (Geospace Environmental Modeling) reconnection problem, which is described in J. Birn, J.F. Drake, M.A. Shay, et al., “Geospace Environmental Modeling (GEM) Magnetic Reconnection Challenge,” *J. Geophys. Res.-Space Physics* **106**:A3 (March 1, 2001) 3715. Results from several codes for both the “resistive MHD” model and for the “two-fluid” model, which has the Hall terms added to the generalized Ohm’s law, are presented.

The “resistive MHD” benchmark uses the resistive MHD equations with the parameters in the above reference. Comparisons are presented in Figure 3 for two values of the fluid viscosity. In the first, the dimensionless viscosity is ten times the dimensionless resistivity. This is the “high viscosity case” (lower curves) and is the one described in the Birn, et al., reference. In the second, the viscosity is reduced by a factor of 100, so that it is 1/10 times the dimensionless resistivity. This is the “low viscosity case” (upper curves). References for the codes and for the resolution settings, as well as a full set of parameters defining the problem are given on the site <http://w3.pppl.gov/ceem/gem.htm>. As can be seen from the figure, the five codes agree for both of the parameter settings better than 3% on average.

The second benchmark involves using the “two-fluid” form of the MHD equations, which is a more realistic description of a fusion plasma. Mathematically, it involves additional terms in the magnetic field evolution equation that are neglected in the resistive MHD description. These terms can have a large effect in magnetic reconnection calculations as can be seen in comparing the results of Figure 4 with those in Figure 3. It can be seen that the three codes applied to this benchmark agree well with one another, and that the peak in the kinetic energy can be 30 to 40 times as large as it was in the corresponding case shown in Figure 3 using the resistive MHD description. Work is currently underway to investigate the effect of the two-fluid MHD equations on a variety of plasma instabilities present in fusion devices.

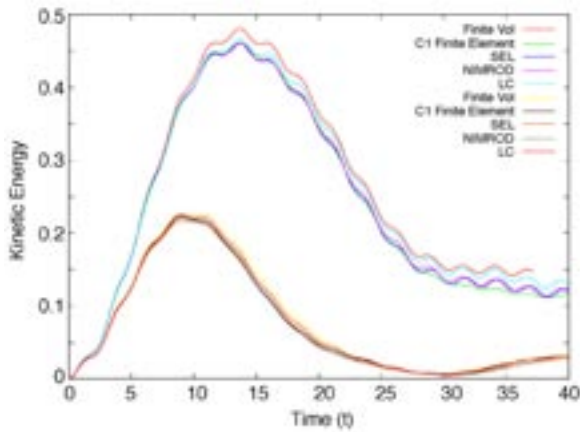

Figure 3. Benchmark runs showing the kinetic energy versus time for a low viscosity case (upper curves) and a high viscosity case (lower curves) from five different resistive MHD codes.

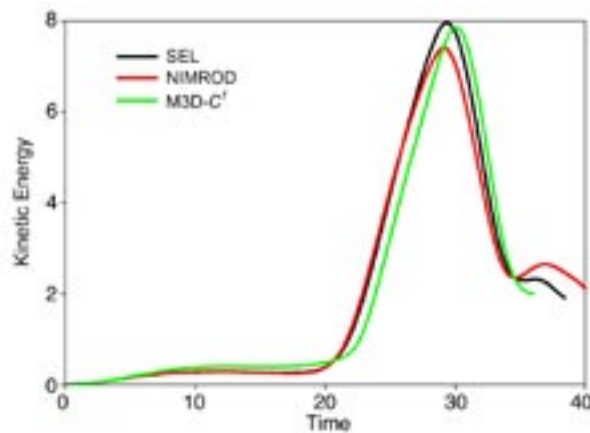

Figure 4. Benchmark runs showing the kinetic energy versus time for a two-fluid model applied to the reconnection problem from three different extended MHD codes.

Physics Investigation of Pellet Fueling

Injecting small pellets of frozen hydrogen is a proven method of fueling tokamaks. Previous results of 3-D extended MHD simulations of pellet injection are in qualitative agreement with experiments, i.e., high-field-side (HFS) fueling is observed to be more efficient than low-field-side (LFS) fueling. However, a quantitative understanding of the pellet-mass redistribution processes leading to transport across surfaces was lacking.

At least two viewpoints have been proposed: one is that the transport of mass across flux surfaces is accompanied by reconnection; while the other one suggests that the flow in the vicinity of the pellet is in the low-magnetic-Reynolds number regime so that the high-density cloud simply slips through the magnetic field. A systematic study of this process has been conducted using 3-D simulations in idealized geometry of the motion of localized regions of high-density plasma as they move across magnetic field lines. In the simulations, a localized region of high density which mimics a fully ablated pellet cloud is initialized, and the pressure in this region is varied from that of the background plasma (i.e., the cloud is cold) to the case where the temperature in the cloud is the same as the background plasma temperature (i.e., the cloud is hot and is essentially a high-beta plasmoid). It is found that the hot cloud moves much more rapidly along the major radius direction.

A time sequence of the density is shown in Figure 5. The radial location of peak density is plotted as a function of time, for different cloud temperatures, in Figure 6, which shows that the cloud speed is approximately constant after a brief initial transient. The cloud speed varies from approximately $0.01V_A$ to $0.06V_A$ (where V_A is the Alfvén speed based on the toroidal field at the magnetic axis and the initial density). Neither varying the Lundquist and the Reynolds numbers nor variation of the poloidal beta had any significant effect on the cloud speed.

It was found that the mechanism for cross-field transport is most consistent with an interchange instability (similar to Rayleigh-Taylor). This work is a continuation of our collaboration with the APDEC (Applied Partial Differential Equations Center) SciDAC Center at the Lawrence Berkeley National Laboratory (LBNL) using generalized up-winding techniques and employing the Chombo framework for adaptive mesh refinement to mitigate the need for large spatial resolution requirements.

Introduction of TEQ Equilibrium Solver in TRANSP

The ability to reconstruct the MHD equilibrium within TRANSP has been enhanced with the addition of the prescribed boundary solver in TEQ. The TEQ

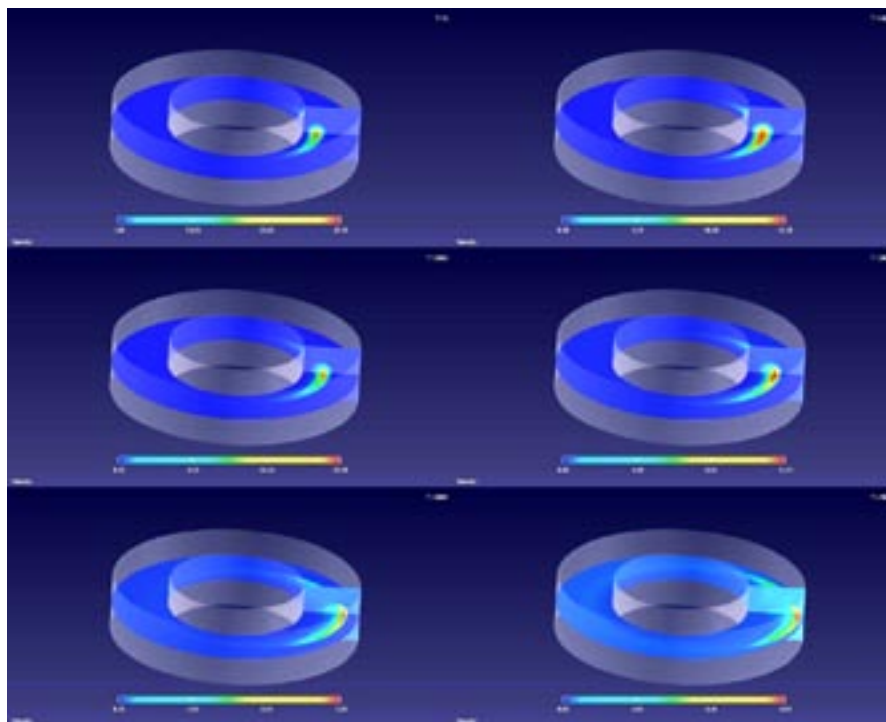

Figure 5. Time sequence of the density in the calculations where a high-density region is transported across the magnetic field. Both cold and hot density regions were studied.

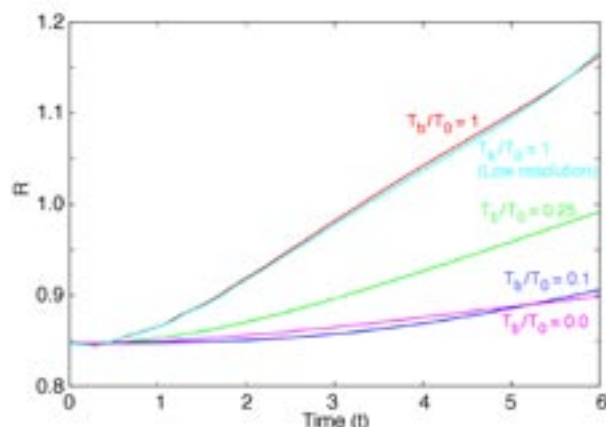

Figure 6. Time history of the radial position of the peak density for a series of calculations with Lundquist number $S=1,000$ and Reynolds number $Re=1,000$.

equilibrium solver was extracted by Lawrence Livermore National Laboratory (LLNL) from within their Corsica transport code as a Fortran 90 NTCC (National Transport Code Collaboration) module. In collaboration with LLNL this was integrated within TRANSP to provide code, which has proven to be robust and accurate even for the challenging geometries of the spherical tokamaks such as the National Spherical Torus Experiment (NSTX) and the Mega-Ampere Spherical Torus (MAST). In Figure 7 is shown the average error returned

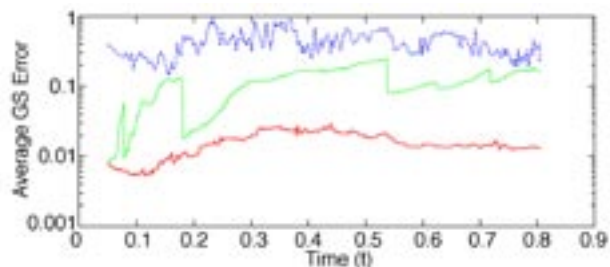

Figure 7. The average Grad-Shafranov error returned by TEQ is typically much better than the other solvers used in TRANSP (TEQ curve shown in red).

from the TEQ code versus time for a typical TRANSP run, and this is compared with the error returned from the previous solvers. Use of TEQ is now routine within TRANSP production runs.

TRANSP Run Production

Now in its fourth year of operation, the number of TRANSP runs executed on PPPL's FusionGrid computational service more than doubled from the previous year. During the year prior to the 2006 American Physical Society Division of Plasma Physics Meeting, 2,918 TRANSP runs were completed for a total of 27,251 CPU hours, as shown in Figures 8 and 9. Over the same period in 2005, 1,353 runs were completed for a to-

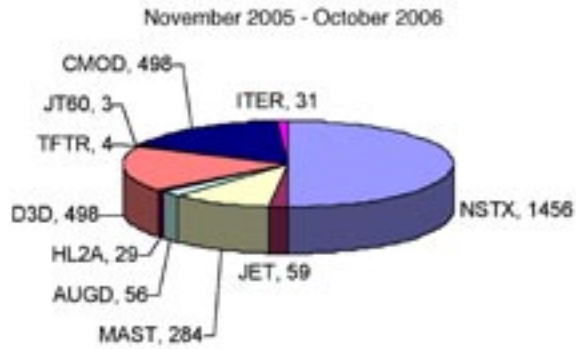

Figure 8. TRANSP production runs by experiment in the year preceding the 2006 American Physical Society Division of Plasma Physics meeting

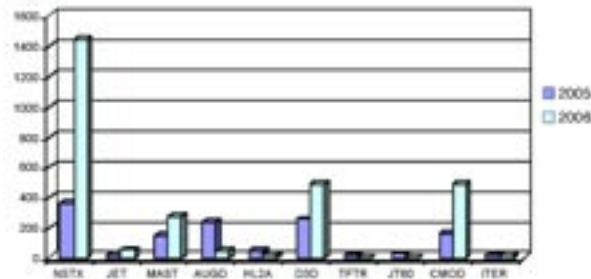

Figure 9. Comparison by experiment of 2005 and 2006 TRANSP production runs.

tal of 8,541 CPU hours. Documentation, scripts and utility code to help prepare and submit runs to the service have been provided at <http://w3.pppl.gov/transp>. Users of the service monitor the progress of their runs at http://w3.pppl.gov/transp/transpgrid_monitor, which gives links to log files and browser enabled graphics of the input data and namelist selected runtime data. Any run which experienced a problem during execution was examined by a PPPL expert and the results of the analysis were communicated back to the user through the web interface or by e-mail. Security for the service and the user's data has been provided through the use of FusionGrid Certificates. About 100 users are currently registered with the TRANSP compute service.

Parallel Services for Multi-physics Simulation (TRANSP)

A parallel computational service consisting of a serial client (TRANSP) and a parallel server (NUBEAM) has been successfully tested. The tokamak transport analysis code TRANSP has a large number of modules, which have traditionally run in a serial mode. However, accurately modeling plasma processes involving fast-ion behavior requires computational power not available on a single processor machine. To meet this

need, the Monte Carlo fast-ion module NUBEAM was parallelized and is now running as a separate "parallel service." A Client-Server model is used where the serial client (TRANSP) runs on a PPPL serial server, while the parallel NUBEAM service is run on a parallel server (Linux cluster). The Globus toolkit handles authorization, file transfers between the client and the server, and executes a remote command that puts NUBEAM in the parallel queue. The serial client invokes the parallel service repeatedly — on the timescale for updates of beam ion heating profiles — but a parallel processor batch queue wait is endured only on the initial invocation. The service has been tested for particle sizes ranging from 10,000 to 300,000 and on up to 32 processors. NUBEAM scales very well for large particle sizes. Table 1 shows the scaling (defined as the ratio of time for a one processor run to the time for a n processor run) for a 300,000 particle run for a single time point.

Figure 10 shows the wall clock time for a time dependent run, including serial TRANSP and service communication costs, using 300,000 Monte Carlo particles per species. Improvements to reduce the service invocation overheads are being pursued.

Table 1. Parallel Scaling Properties of NUBEAM.

Procs	Ideal Scaling	Actual Scaling
1	1.00	1.00
2	2.00	1.99
4	4.00	3.94
8	8.00	7.57
16	16.00	13.99
32	32.00	24.40

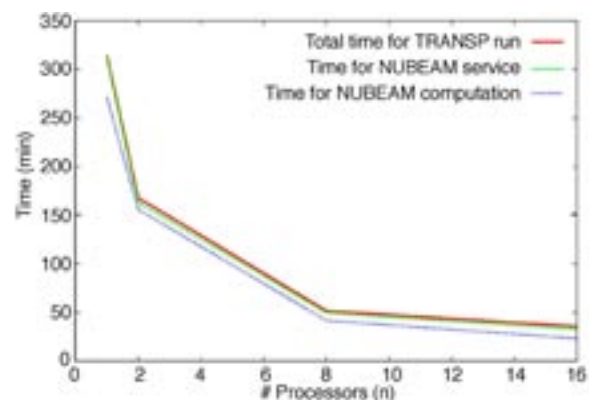

Figure 10. Total TRANSP code run time, run time for the NUBEAM service, and portion of run time for NUBEAM only.

Graphical Web Service for Reflectometry Simulation

Building a web service around PPPL's 2-D wave propagation code, FWR2D, has been an effective approach for adding graphical input, visualizing the output, and making the simulation more widely available to scientists. A multi-tier system was developed to optimize computing and display resources while making minimal changes to the original Fortran code and runtime environment. The reflectometry web service is seen as a prototype for other plasma physics applications services. A set of reusable scientific graphics classes were developed which would be suitable for a wide range of fusion codes.

A reflectometer emits radio-frequency waves toward the plasma and measures the amplitude of the reflected wave. Turbulence and fluctuation in the plasma can be located by correlating the reflection of different frequency waves. Reflectometers are expensive to build and the number of experimental plasma discharges for acquiring data is limited. Therefore simulation is essential before design, fabrication, and deployment. The 2-D wave propagation code was written in Fortran by Ernest Valeo and Gerrit Kramer. The goal was to add a graphical user interface to set up a run, automate visualization of the output, and make it available to physicists at different institutions running various computer platforms.

The graphical user interface, "El Fresco," was written in Java by Eliot Feibush to achieve portability to Windows, Macintosh, and Linux operating systems. El Fresco runs on the scientist's personal computer to take advantage of the tightly coupled graphics and achieves good interactive performance.

Implementing the Java program as an "applet" enables users to access it through a web browser and then automatically run the latest version without installing application software on their computers. An applet has security restrictions, so a Java "servlet" was developed for controlling the simulation program and accessing files on the server side. The applet sends requests to an HTTP server which forwards them to an Apache Tomcat servlet container inside the firewall. Each run is set up and processed in a protected directory on the server. Then it is listed and managed in the run history window in the applet. For grid portal security, each user has an X.509 credential stored on a MyProxy server. The user simply enters a password and does not have to manage local security data because the servlet retrieves the credential, as shown in Figure 11. Tomcat and the grid security were supported by Lew Randerson.

The input plasma contains 2-D cross sections of electron density, temperature, and magnetic field strength. The reflection location for a specific wavelength is calculated on the server and visualized in the applet. This enables the user to efficiently choose wavelengths for studying turbulence at a specific reflection layer in the plasma.

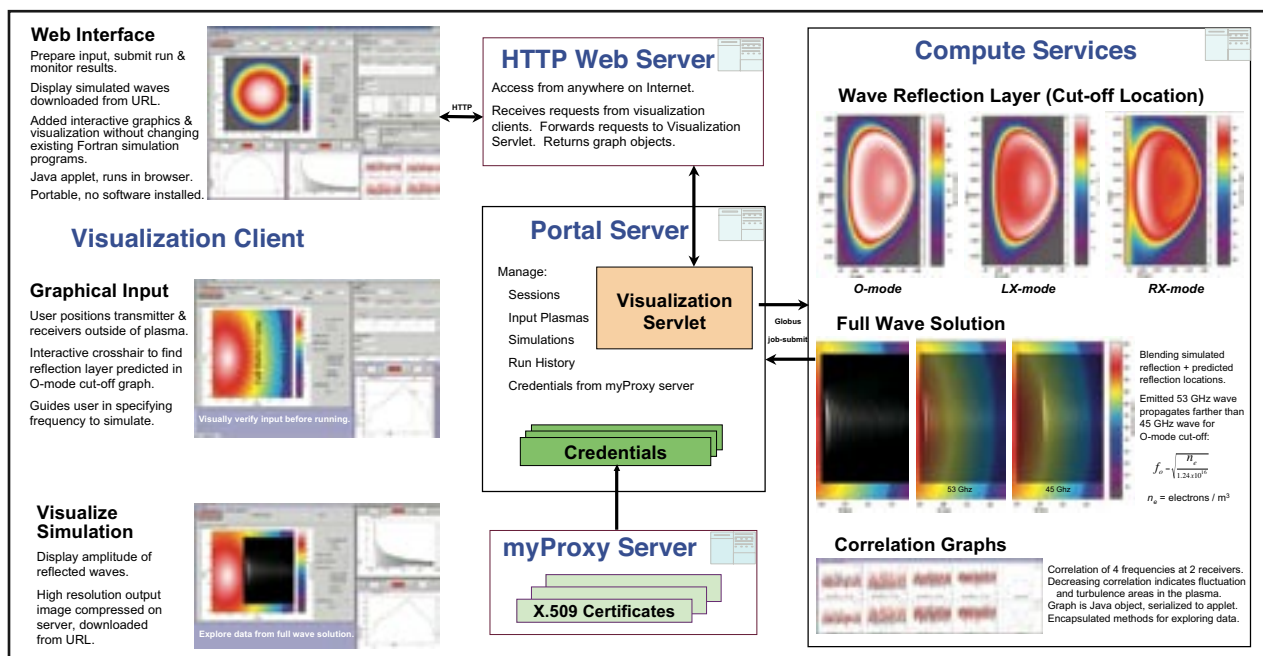

Figure 11. Multi-tier architecture of reflectometry web service. Three screen shots from the visualization client show the graphical user interface. Compute services running at PPPL calculate the reflection layer, the full wave solution, and the correlation graphs. They are displayed in the visualization client.

The simulation outputs even larger amounts of 2-D data. The entire input and output datasets are stored in double precision in the run directory on the server. Only the data needed for display is scaled to bytes and sent to the client where it is color coded. Blending the simulated reflection with the input is very effective for visualizing the reflected waves, particularly when zooming in on the data. There are six input images and three com-

puted images that can be displayed in any combination. The two selected images are blended in an image buffer in the applet.

The correlation between frequencies is calculated on the server where all the data is accessible. The Java servlet creates a graph object and sends it to the Java applet that has corresponding methods for displaying and exploring the graph (see Figure 11).

Space Plasma Physics

The Space Plasma Physics Group at the Princeton Plasma Physics Laboratory (PPPL) has been modeling the dynamical evolution of the solar-terrestrial system so as to understand how energy and momentum are coupled between the sun, magnetosphere, and ionosphere. The progress in understanding the transport from the solar wind to the magnetosphere and a new method to derive magnetic reconnection rates in solar flares which control the release of energy from the sun is describe in this report.

Magnetopause Transport for Northward Interplanetary Magnetic Field

When the interplanetary magnetic field is northward (aligned with the earth's dipole magnetic field) observations show that the plasma sheet of the magnetosphere becomes colder and denser. Two aspects of the development of plasma sheet plasma profiles have been investigated in collaboration with observers at the Johns Hopkins University's Applied Physics Laboratory: (1) the time scale of densification and (2) the symmetry properties of the profiles.

Both statistical and case studies were performed of plasma sheet densification using in situ satellite observations and remote techniques based on mapping ion precipitation from ionospheric satellites to the plasma sheet. An example of a case study is given in Figure 1, where plasma density is shown as a function of time for February 4–5, 2005. Global statistical estimates of density from remote observations are shown for dawn and dusk as well as in situ GEOTAIL density. At $\Delta t = 20$ hr the interplanetary magnetic field turned northward and remained so for approximately one day. During this period a maximum filling rate of around 0.5 particles per cubic centimeter per hour (particles/cc-hr) was estimated. These results were compared with theoretical estimates from dayside entry due to cusp reconnection or diffusive processes. For cusp reconnection, the entry flux was estimated assuming a rotational discontinuity at the magnetopause boundary and integrating over the open magnetopause. For this case, the open magnetopause maps to the cusp which is well defined by particle precipitation observations. For diffusive entry, the entry due to Kelvin-Helmoltz instabilities and kinetic

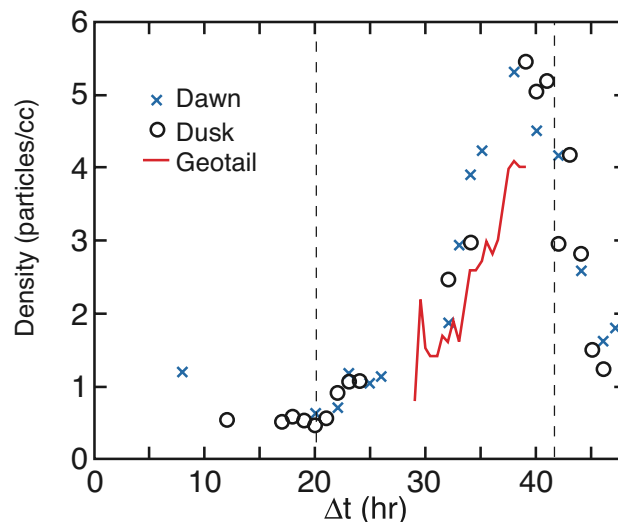

Figure 1. Plasma density on February 4–5, 2005 as inferred from DMSP ionospheric satellites (for dawn and dusk) and from in situ GEOTAIL satellite measurements. The interplanetary magnetic field turns northward after $\Delta t = 20$ hr and remains northward for nearly a day. The plasma sheet clearly densifies with a maximum filling rate around 0.5 particles/cc-hr.

Alfvén waves was estimated based on transport coefficients derived from simulation and theory. For the solar wind parameters observed on that day, it was found that either mechanism would give a plasma sheet filling rate around 0.5 particles/cc-hr. However, the estimate did show that the filling rate should scale as $n^{1/2}$ for reconnection versus n for diffusive entry where n is the solar wind plasma density. This work was recently published in the *Journal of Geophysical Research* [S. Wing, J.R. Johnson, and M. Fujimoto, “Timescale for the Formation of the Cold-dense Plasma Sheet: A Case Study,” *Geophys. Res. Lett.* **33**:23 (9 December 2006) Article No. L23106]. Future work will be to examine the density dependence of plasma sheet filling in statistical studies.

Unfortunately, the plasma-filling rate does not provide a definitive test of the competing transport mechanisms. However, asymmetries in global plasma profiles provide an additional constraint. In Figure 2 is shown the global plasma profile of: (a) density and (b) temperature [S. Wing, J.R. Johnson, P.T. Newell, and C.-I. Meng, “Dawn-dusk Asymmetries, Ion Spectra, and Sources in the Northward Interplanetary Magnetic Field Plasma Sheet,” *J. Geophys. Res.* **110**:A8 (August 2005) Article No. A08205”]. Two features stand out in these observations. First, the density is maximum along the magnetopause boundary of the plasma sheet, suggestive that there is a plasma source along the boundary. Secondly, there is an asymmetry in the plasma density and temperature. The cold component enters more efficiently on the dawnside and is heated relative to the duskside plasma entry. To date, there has been no obvious explanation why reconnection or Kelvin-Helmholtz instabilities might provide such an asymmetry. However, kinetic Alfvén-induced transport would have a natural asymmetry because kinetic Alfvén waves result from mode conversion of compressional waves that have a source in the magnetosphere’s foreshock that is statistically on the dayside due to the Archimedes spiral nature of the interplanetary magnetic field. It has also been shown that the heating on the dawnside is consistent with heating that would occur in kinetic Alfvén waves for observed wave amplitudes.

A Novel Method to Derive Magnetic Reconnection Rate in Solar Flares

A solar flare releases 10^{28} – 10^{32} ergs of energy as electromagnetic radiation. This energy is believed to come from the free magnetic energy in solar active regions. It is magnetic reconnection that converts the magnetic energy into kinetic energy and thermal energy of electrons and other particles, which will eventually be emitted as radiation. The measured solar flare energy

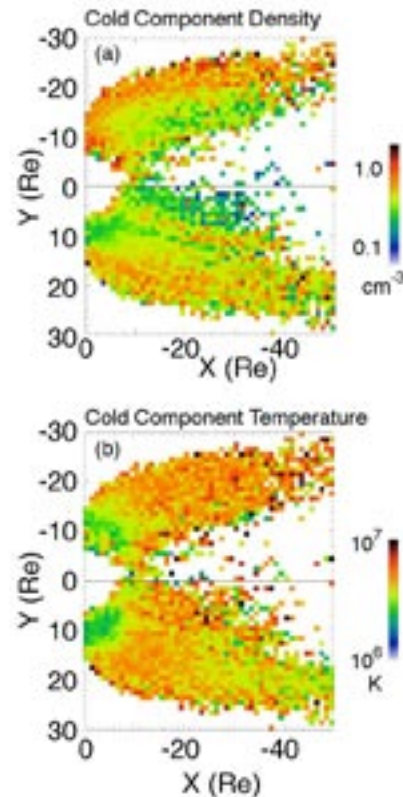

Figure 2. Global plasma density (a) and temperature (b) profiles inferred from remote statistical observations from DMSP ionospheric satellites for northward interplanetary magnetic field. Asymmetries are apparent in the plasma density and temperature that would be consistent with an entry process that is more efficient on the dawnside that is associated with heating. Of the mechanisms proposed to date, kinetic Alfvén wave transport is physically associated with asymmetry based on asymmetries in the wave source.

requires a very efficient magnetic reconnection process. The required reconnection rate, which is the Alfvén Mach number of the plasma inflow into the reconnection current sheet (RCS), is of the order of 0.01–0.1. Many numerical experiments have achieved this high reconnection rate, but only by assuming unrealistically high, localized resistivity. Thus, it has remained as an open question whether a magnetic reconnection process in the sun really takes place with such a high rate that requires enhancement of local electrical resistivity by 8–10 orders of magnitude from the classical value. This question can only be answered by measuring the magnetic reconnection rate in solar flares, but no method has existed for doing it.

Recently, observers at Big Bear Solar Observatory (BBSO) of the New Jersey Institute of Technology (NJIT) measured the area and speed of the moving flare ribbons in the H α blue wing. Since the H α blue wing

forms when the chromospheric material evaporates by precipitating high-energy electrons, the ribbon image in the $H\alpha$ blue wing can be considered as a silhouette of the coronal reconnection region projected onto the chromosphere. While working with the researchers at the NJIT under the PPPL University Collaboration Program, Gwang-Son Choe at PPPL derived the following formula for relating the magnetic reconnection rate with the area and velocity of the $H\alpha$ blue wing ribbons and the energy release rate (see Figure 3):

$$M = 2|v_f B_f^2 A_f| / \pi(d\epsilon_{em}/dt),$$

where v_f and A_f , respectively, are the velocity and the area of the $H\alpha$ blue wing ribbon moving on the solar disk, B_f is the magnetic field component normal to the solar surface, and $d\epsilon_{em}/dt$ the energy release rate. Figure 4 shows observed physical quantities of an $H\alpha$ blue wing ribbon and the energy release rate for $M = 0.1$. The real energy release rate cannot be exactly measured, but the

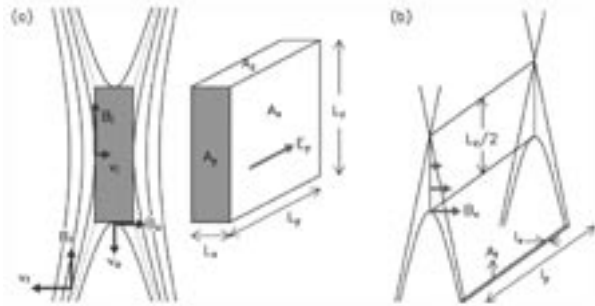

Figure 3. Schematic plots of the magnetic field configurations around the reconnection rate sheet (RCS). (a) Electromagnetic field, velocity, and area vectors (thick arrows) and the lengths of the sides of the RCS (thin arrows). The shaded region represents the cross section of the RCS in the x - z plane, and the dotted lines are the separatrices. The subscripts i , o , and f represent the incoming, outgoing, and footpoint field lines, respectively. (b) RCS and flare ribbon shown together to illustrate their relationship. The ribbon area is $A_f = l_x l_y$, and the RCS area pointing to the x -axis is $A_x = L_y L_z = l_y L_z$.

energy deposition rate to the X-ray emitting electrons can be estimated from the energy distribution of the electrons, which is obtained by inverting the observed X-ray spectrums. The electron energy deposition rate thus obtained is 10% to 80% of the energy release rate for $M = 0.1$. This shows that the magnetic reconnection rate in the solar flare is indeed of the order of 0.1. A paper on this result was published in *Astrophysical Journal* [J. Lee, D.E. Gary, and G.S. Choe, "Magnetic Energy Release during the 2002 September 9 Solar Flare," *Astrophys. J.* **647**:1 Part 1 (10 August 2006) 638–647].

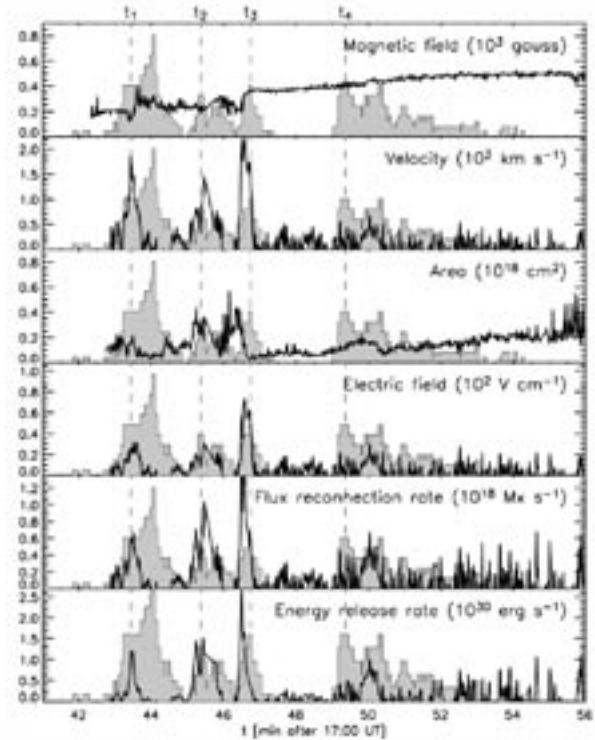

Figure 4. Physical parameters of the magnetic reconnection in the September 9, 2002 flare as functions of time. The top three panels show observed parameters: normal magnetic field strength along the path of the $H\alpha$ blue wing ribbon, ribbon velocity, and area. The bottom three panels show derived quantities: electric field, flux reconnection rate, and energy release rate for $M = 0.1$. The gray histogram in each panel shows the RHESSI count rate at 25–50 keV for reference.

Off-site Research

The Princeton Plasma Physics Laboratory's (PPPL's) Off-site Research Department seeks to broaden the contributions of our engineers and scientists by providing access to leading fusion research facilities worldwide. Working side-by-side with their colleagues in multi-institutional teams allows PPPL staff to learn from others as well as to impart their knowledge and experience. Integrated teams of experimentalists, theorists, and engineers can tackle the important scientific and technical issues on a variety of devices, comparing and contrasting phenomena on different scales, and in different configurations. In particular, the Off-site Research Program provides PPPL scientists and engineers with access to leading tokamak facilities throughout the world.

DIII-D Collaboration

PPPL researchers have made major new contributions to fusion science on DIII-D in the physics and technology of the Advanced Tokamak (AT). The AT mission of the U.S. Department of Energy (DOE) is to develop the scientific basis of a high-pressure self-sustained tokamak plasma discharge. Major PPPL contributions to this DOE mission are highlighted by high impact publication of leading-edge scientific results, invited talks at key scientific meetings, and rapid advances in key areas of fusion technology that are critical to the future success of the AT line of research. Areas where PPPL makes a large impact on the development of the Advanced Tokamak are:

- Energetic particle phenomena,
- Transport physics,
- MHD stability, and
- Radio-frequency heating and current drive.

Energetic Particle Phenomena

PPPL has made new contributions to the understanding of Alfvén waves driven by energetic and thermal particles. The key development led by PPPL physicists working on the DIII-D device is that Alfvén waves driven by thermal and fast ions are far more prevalent in tokamak plasmas than previously understood (Figure 1). As fusion alpha particles will interact with such waves,

understanding such phenomena is essential to predicting the behavior of a future reactor such as ITER. The new insight gained by PPPL researchers has spawned many new experiments in international facilities trying to reproduce and extend these results. Most notable is a joint experiment between the DIII-D and the Joint European Torus (JET) tokamak in the European Union, which explored the low-energy resonance condition for the excitation of Alfvén eigenmodes.

In addition to experiment, PPPL is a leader in the application of leading-edge theory codes to the understanding of experimental data analysis of energetic-particle-driven modes in DIII-D, Alcator C-mod, the National Spherical Torus Experiment (NSTX); international facilities such as the Joint European Torus (JET) and JT-60U make use of the linear stability code NOVA-K developed by PPPL researchers.

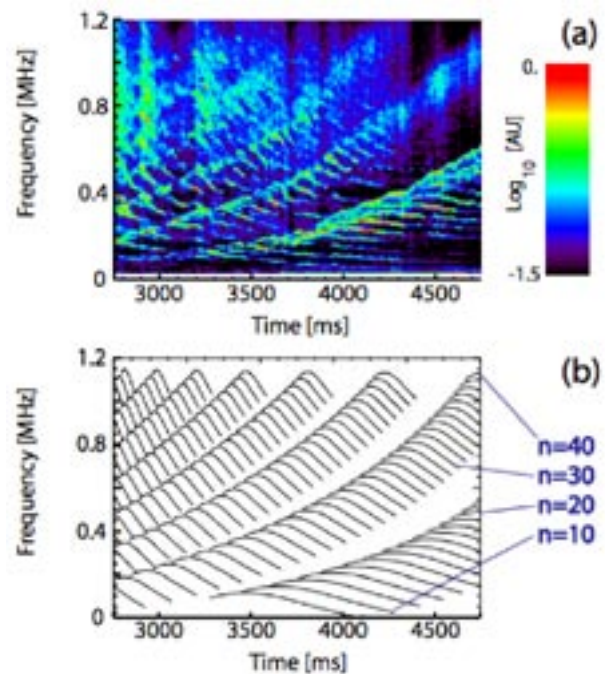

Figure 1. Frequency spectrum of Alfvén-wave eigenmodes in the DIII-D tokamak experiment versus time. (a) Density fluctuations measured by scattering far-infrared waves. A is a measure of scattered power. (b) Theoretically predicted spectrum.

Transport Physics

PPPL has taken leadership in producing the first reliable measurements of poloidal plasma rotation in a fusion plasma. Rotation (poloidal and toroidal) is a basic property of plasmas that impacts all other elements of plasma performance such as MHD stability and limits on plasma pressure. The successful attempt to measure the relatively small level of poloidal plasma rotation in DIII-D has potentially high scientific payoff in understanding the transport of momentum in ITER.

More recently, PPPL has taken a leadership role in the understanding of momentum transport in DIII-D beam-heated plasmas with low net injected torque. The investigation of low-rotation plasmas is a central element of the DIII-D program aimed at validating and extending the AT database to more reactor-relevant parameters. Preliminary results of these measurements were presented at the *16th High-temperature Plasma Diagnostics Conference* in Williamsburg, VA, in May 2006. A key new observation is that there is a large level of residual plasma rotation with zero net injected torque into the plasma. The residual rotation is substantial, of the order of the rotation produced with one co-beam injection source (Figure 2). The analysis of the anomalous momentum source and radial momentum flux from the injected neutral beams is being pursued experimentally and theoretically with the application of advanced gyrokinetic simulation codes. The central questions these studies are addressing are what determines plasma rotation and ultimately how, and to what extent, a reactor-grade plasma will rotate in the laboratory frame of reference. The answers to these questions have profound implications for the macroscopic and microscopic stabil-

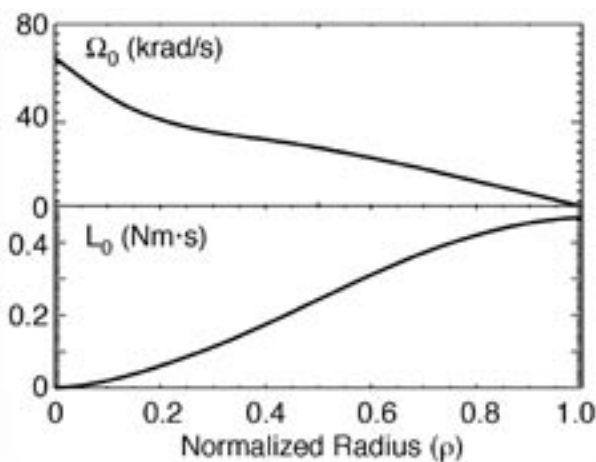

Figure 2. Intrinsic rotation frequency (upper) and inferred anomalous torque (lower) plotted versus normalized radius, in the case where there is zero net torque applied from neutral beams.

ity of a fusion plasma and hence on the maximum pressure and level of thermal confinement that the plasma can sustain.

PPPL expertise is also engaged in the measurement and interpretation of fluctuation measurements on DIII-D. Princeton is a world leader in the precision measurement of core fluctuations in fusion plasmas using microwave techniques and advanced simulation capability aimed at interpreting the complex signals obtained from the scattering of microwaves off of plasma turbulence. In the last year, PPPL researchers have established a new collaborative program with the University of California at Los Angeles (UCLA) to apply advanced simulation tools developed at PPPL for the analysis of microwave data. This new tool, the full wave reflectometer (FWR) code, has already been instrumental in performing a detailed design analysis of microwave systems planned for ITER. This analysis capability is unique in the world and was developed through the PPPL DIII-D collaboration program in conjunction with PPPL's Theory and the Computational Plasma Physics groups.

MHD Stability

The primary concern for the AT is the accessibility of stable high-pressure regimes with large levels of self-driven (bootstrap) current. High pressure is essential for efficient fusion energy production and for driving currents that will enable the plasma to maintain itself in a steady state. The primary instability in accessing high pressure is the resistive wall mode (RWM). PPPL is a leading institution for the understanding and control of RWMs, and the DIII-D program is a primary focus of PPPL's research effort in this area. PPPL contributes to RWM physics in collaboration with General Atomics and Columbia University researchers. A key new capability of PPPL researchers is the application of state-of-the-art simulation tools such as the Normal Mode Analysis (NMA) code to experimental data. The NMA code represents an advance in rigid mode models and will be a central contributor to the design analysis of ITER control coils. In addition to theoretical and experimental advances, PPPL provided the engineering and design leadership for the implementation of the audio amplifier upgrade employed for controlling the RWM modes in DIII-D.

Radio-frequency Heating and Current Drive

PPPL researchers play a key leadership role in the development of radio-frequency heating and current-drive systems on DIII-D. This area of technology is essential for the start up and control of a future fusion reactor and for simulating the conditions expected in



Figure 3. Completed socket assembly for the new radio-frequency high-power tube installation on DIII-D.

fusion reactors in today's facilities. This year PPPL delivered its fourth and final electron-cyclotron wave launcher (P2006) to DIII-D. By this delivery, PPPL satisfied a major program milestone for DIII-D on time and on budget. These microwave launchers are equipped to steer several megawatts of radio-frequency power into the plasma. The successful design and engineering of these launchers by PPPL staff has enabled seminal work to be performed on DIII-D, demonstrating the effective control of neoclassical tearing modes (NTMs).

Another area of plasma control is in the effective coupling of radio-frequency fast waves into plasma, affecting the central electron temperature and central plasma current. Historically, PPPL has been a leader in developing the transmission line and antenna technology for effectively coupling these low-frequency (100 MHz) radio-frequency waves into plasma. In FY06, PPPL, the Oak Ridge National Laboratory (ORNL), and GA collaborators succeeded in installing a new high-power tube (see Figure 3) for the delivery of 2 MW of radio-frequency power to the fast-wave antennas on DIII-D. The tube installation and commissioning were performed on time and on budget. This accomplishment represents a major technical milestone that will help accomplish one of the highest priority goals for the U.S. fusion program — operating DIII-D in more reactor-relevant conditions of higher electron temperature and direct electron heating. Already the team has injected 1.5 MW into dummy loads, and first plasma experiments with the new source are expected in mid FY07.

Alcator C-Mod Collaboration

The PPPL-Massachusetts Institute of Technology (MIT) Alcator C-Mod collaboration program concentrates on issues associated with AT development and ITER-relevant tokamak research utilizing the Alcator

C-Mod tokamak at the MIT Plasma Science and Fusion Center in Cambridge, Massachusetts. The Laboratory plays an active role in diagnostic development and support (motional Stark effect, microwave reflectometry, X-ray measurements, and gas-puff imaging measurements) and in heating system research and technical support.

Lower-hybrid Current Drive

During FY06, experiments commenced on Alcator C-Mod utilizing the completed lower-hybrid current-drive (LHCD) system, representing the culmination of a multi-year joint project between MIT and PPPL. The goal of the LHCD Project is to drive sufficient off-axis plasma current to generate and sustain AT plasma regimes that have improved energy confinement and stability. High-power commissioning experiments during FY06 demonstrated the system's capability to couple large power levels (up to 1 MW) and to drive plasma currents (up to 1 MA).

An important LHCD performance parameter is the current-drive efficiency, i.e., how much plasma current can be driven by a given amount of LHCD power. The efficiency of the current drive can be inferred experimentally by measuring the loop voltage in a scan of LHCD power. An efficiency of $\eta = 3.0 \pm 0.1 \times 10^{19}$ A/Wm² is inferred from the plot of loop voltage versus normalized LHCD power shown in Figure 4, which compares well with previous LHCD experiments and with modeling predictions for these plasma conditions. Measurements of the X-ray emission profile supported by magnetic equilibrium calculations indicate that current is being driven off-axis, in agreement with theoretical expectations.

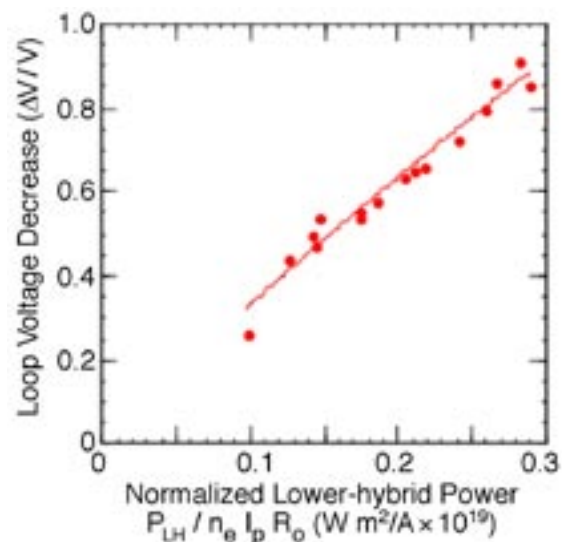

Figure 4. Loop voltage decrease versus normalized lower-hybrid power.

The LHCD hardware system was designed to generate a wide range of launched parallel wavelength that can be varied on a rapid time scale (one millisecond). Varying the launched parallel wavenumber showed increased efficiency at long wavelengths as expected from theory. The success of these experiments in FY06 sets the stage for applications of current drive to AT relevant discharges.

Edge Turbulence

One goal of the PPPL edge turbulence studies at Alcator C-Mod is to understand the high-frequency edge fluctuations observed by the gas puffing imaging (GPI) diagnostic on the basis of first-principles theory. An experiment was carried in FY06 to specifically test predictions of the GEM (Gyrofluid Electromagnetic) edge turbulence simulation code. This comparison was carried out in conditions relatively easy for the code to simulate: a high-density, near-circular, inner-wall-limited plasma that had a large outer scrape-off layer (SOL) in which the edge turbulence was measured. Turbulence simulations were performed for the SOL based on plasma profiles measured by a scanning Langmuir probe. Figure 5 shows the theoretically calculated frequency spectrum of the SOL turbulence in Alcator C-Mod, compared with the actual spectrum measured by the gas puff imaging (GPI) diagnostic. The curve with the open circles is the GPI-measured spectrum in the outer midplane SOL of an inner-wall-limited discharge, and the curve with the solid points is the result of the GEM simulation code run for this location for this shot (from B. Scott of IPP Garching). The shapes of the simulated and measured frequency spectra are similar, and the measured auto-correlation time is in the range 12–21 μsec compared to 9 μsec in the turbulence simulation, which is encour-

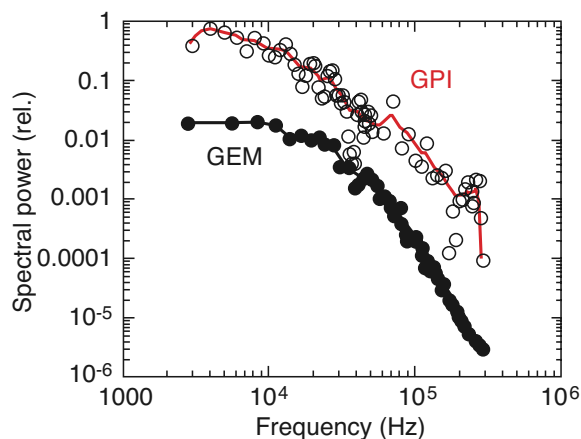

Figure 5. Comparison of the frequency spectrum measured in the scrape-off layer of Alcator C-Mod (labeled GPI) with the predictions of the GEM edge turbulence simulation code.

aging. The predicted and measured poloidal and radial correlation lengths also agree within about a factor of two, i.e., about one cm and 0.5 cm in the simulation, respectively, compared with 1.3–2.1 cm and 0.9–1.6 cm in the measurements.

The simulation predicts structures that are somewhat higher in frequency and smaller in size than observed experimentally. One significant difference between the simulated and measured turbulence is in the relative density fluctuation level, which is predicted to be 4–5%, but is measured to be about 20–30%. This initial comparison will be extended in the future to include scans of the most important quantities in the simulation results, namely, the gyroradius and collisionality.

X-ray Crystal Spectrometer

A new type of X-ray imaging crystal spectrometer for Doppler measurements of the radial profiles of core ($t/a < 0.8$) ion temperature and plasma rotation velocity is being developed by PPPL and the MIT team for use on Alcator C-Mod and possibly ITER. The spectrometer consists of a spherically bent crystal and a two-dimensional position-sensitive detector that records the temporally and spatially resolved X-ray line spectrum from highly charged ions (for Alcator, the chosen lines are hydrogen- and helium-like argon, ArXVII and ArXVIII, respectively). The expected spatial and temporal resolutions are 10 mm and 10 ms respectively. A major innovation is the use of recently developed PILATUS II 200 by 500 pixel detector modules that provide a count rate capability of 1 MHz per pixel. The detector performance and suitability for use in a tokamak environment was verified during FY06 experiments. As shown in Figure 6, the spectrometer will view the plasma through B-port at an angle with respect to the toroidal magnetic field to allow measurement of both toroidal rotation and ion temperature.

Effect of Secondary Beam Neutrals on MSE Calibration

The motional Stark effect (MSE) diagnostic developed by PPPL is designed to measure the q-profile on Alcator C-Mod, which will be modified by LHCD to generate AT plasma regimes. The MSE diagnostics are based on the principle that hydrogen atoms moving with velocity \mathbf{v} through a magnetic field \mathbf{B} feel an electric field $\mathbf{E} = \mathbf{v} \times \mathbf{B}$ and emit light that is polarized in a direction parallel to this electric field. MSE diagnostics accurately measure the polarization direction of this emitted light and thereby infer the pitch angle of the local magnetic field which is directly related to the q-profile. Typically, MSE diagnostics are calibrated either by illuminating the system with polarized light generated by

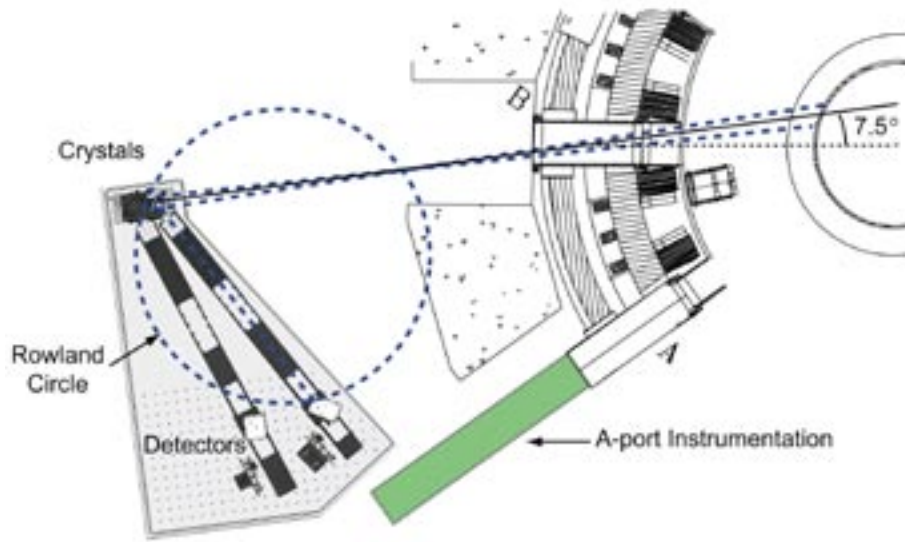

Figure 6. Top view of the X-ray imaging crystal spectrometer for Alcator C-Mod.

a film polarizer installed inside the torus when it is not under vacuum (“in-vessel” calibration), or else by injecting a neutral beam into a torus filled with low-pressure gas that has a magnetic field of known direction applied to it (“beam-into-gas” calibration). In both cases, the known direction of the magnetic field is used to calibrate the angle measured by the MSE diagnostic.

For some time, it has been observed that on Alcator C-Mod these two calibration techniques differ by as much as $\sim 10^\circ$ compared to the required measurement accuracy of $0.1\text{--}0.2^\circ$. The anomalous calibration results have to date precluded use of MSE as a reliable tool to measure the q-profile. During FY06 a new conjecture to explain the calibration discrepancy was tested that is based on the unusual orientation of Alcator C-Mod’s neutral beam, which, unlike all other tokamaks, aims directly perpendicular to the plasma at the horizontal midplane.

The consequence of perpendicular injection is that beam neutrals which become ionized through collisions with background gas have negligible velocity parallel to the magnetic field line, and drift only slowly out of the MSE field-of-view as they gyrate about the magnetic field line. Indeed, under typical conditions, the average beam ion drifts only about 0.25 cm vertically before it experiences charge-exchange again with the torus gas. It thereby becomes neutral once again, but — crucially — at a random gyro angle. These “secondary” beam neutrals generate light at an isotropic polarization angle that confuses the MSE calibration measurements.

Calculations indicate that emission from the secondary beam neutrals is sufficient to explain the $\sim 10^\circ$ anomaly between in-vessel and beam-into-gas calibrations.

More directly, this conjecture explains another previously anomalous phenomenon: the appearance of an unexpected spectral feature on the “blue side” (i.e., short wavelength side) of the unshifted $H\alpha$ line when the beam is injected into gas with an applied magnetic field. Due to the Doppler shift from a beam moving away from the MSE optics, we expect to observe only light shifted to the red side of the $H\alpha$ line, but as shown in Figure 7(a), a small feature is also observed on the blue side when a nonzero magnetic field is applied. In the context of the secondary beam-neutral conjecture, this blue emission is generated by those secondary beam neutrals, which happen to emit light when their gyro-orbit is directed back toward the MSE optical system. Calculations, Figure 7(b), of the expected emission from secondary beam neutrals reproduce semi-quantitatively the magnitude of the blue wavelength shift and its variation with pitch angle and MSE viewing angle.

On the basis of this evidence, Alcator C-Mod’s diagnostic neutral beam will be rotated toroidally by 7° (the maximum amount allowed by access constraints) during early FY07 to reduce the population of the secondary neutrals by a factor greater than 30. Tests in mid-FY07 will determine whether this change resolves the calibration anomalies and thereby restores MSE to an accurate system for measuring the q-profile.

International Collaborations

In order to take full advantage of the world’s investment in fusion research facilities and to better prepare PPPL researchers for the international ITER Project, DOE has funded a program in international collaborations. This allows PPPL researchers access to the JET

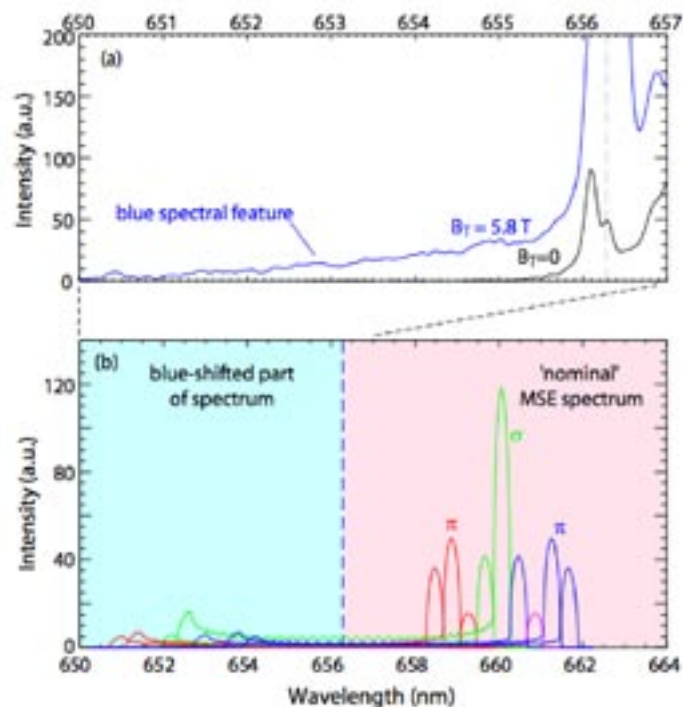

Figure 7. (a) Spectrum emitted by the Alcator C-Mod deuterium neutral beam along a motional Stark effect sightline on the short-wavelength side of the unshifted H α line with and without applied toroidal field. (b) Calculated spectrum due to primary and secondary beam neutrals.

tokamak in Great Britain and to the JT-60U tokamak in Japan, both of which have plasma parameters closest to ITER. PPPL staff also have access to the new long-pulse superconducting tokamaks being constructed in Korea and Japan and to stellarator devices worldwide in preparation for the U.S. revival in stellarator research.

JET

JET is the most powerful magnetic fusion facility in the world. It is the major data provider of the international fusion energy sciences program in its attempt to build ITER and investigate the innovations in toroidal magnetic confinement and to strengthen, through elucidating the underlying plasma physics, the scientific basis for magnetic confinement fusion. JET researchers study plasmas at the closest parameters to ITER and also have the capability to use tritium, making JET the most outstanding and uniquely important fusion facility in the world.

PPPL staff who collaborate on JET offer an important range of expertise, which further enhances the capabilities of this outstanding facility to lead the world fusion effort. By providing these capabilities to JET, PPPL collaborators comprise about 50% of the U.S. access to this world-leading fusion program, and provide the U.S. fusion community with an avenue to test its experimen-

tal ideas, diagnostic innovations, and theoretical insights on the most fusion-relevant plasma.

In FY06, research activity was focused on several ITER-relevant research topics:

Wave-particle Interactions. In FY06, PPPL initiated and helped perform JET experiments investigating the excitation mechanism of reversed-shear Alfvén eigenmodes and toroidal Alfvén eigenmodes and to explore the excitation of a “sea of Alfvén eigenmodes” (see Figure 8), as has been identified by PPPL researchers in the DIII-D device. This is an example of the cross fertilization that off-site collaborations offer. These experiments have been identified as high priority International Tokamak Physics Activities and initial results were reported at the *21st IAEA Fusion Energy Conference* held in Chengdu, China, in October 2006.

Transport Physics. A PPPL reflectometer diagnostic was installed on JET in 2003 to aid in the study of turbulence. After initial shakedown of the diagnostic, experimental data was taken during 2006. Preliminary measurements of the radial scale of the turbulent fluctuations using correlation reflectometry indicate similar — but not identical — spectra to the GYRO code.

Lost-alpha Diagnostics. PPPL fabricated and delivered the in-vessel JET lost-alpha diagnostic hardware to the United Kingdom Atomic Energy Agency in the

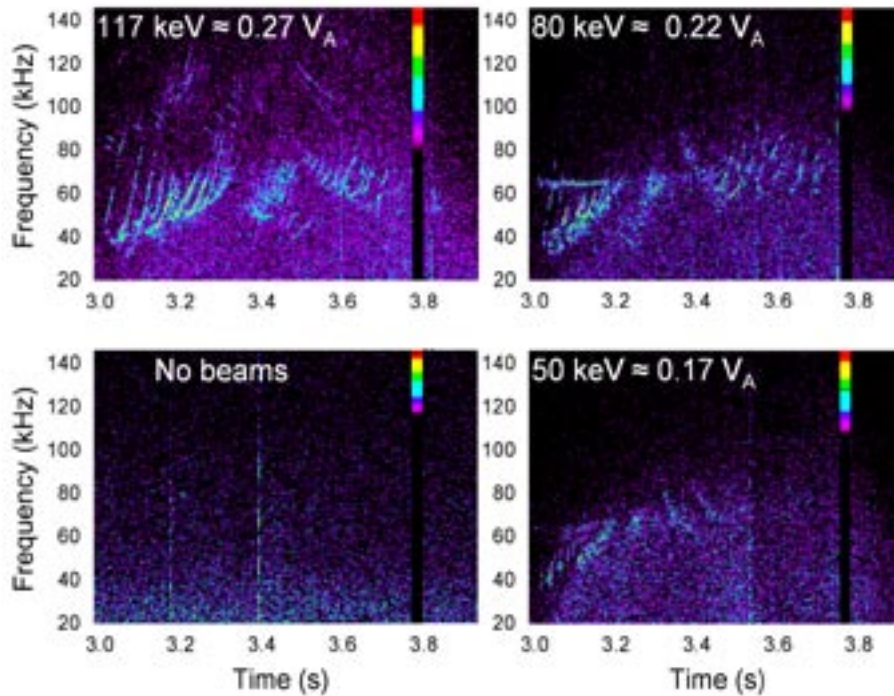

Figure 8. Microwave interferometer signal as a function of neutral-beam injection voltage showing the presence of Alfvén cascade modes at injection velocities well below the Alfvén velocity

spring of 2005 for installation in the vacuum vessel. The detectors were installed in July 2005. The cables and amplifiers were installed at JET and connected to the JET data acquisition system in November 2005. Initial tests with these detectors were aimed at evaluating noise levels and validating the signals. During FY06 the first data was taken with this diagnostic. Figure 9, shows fast-ion losses during ion-cyclotron range-of-frequencies minority heating on the various Faraday cup channels.

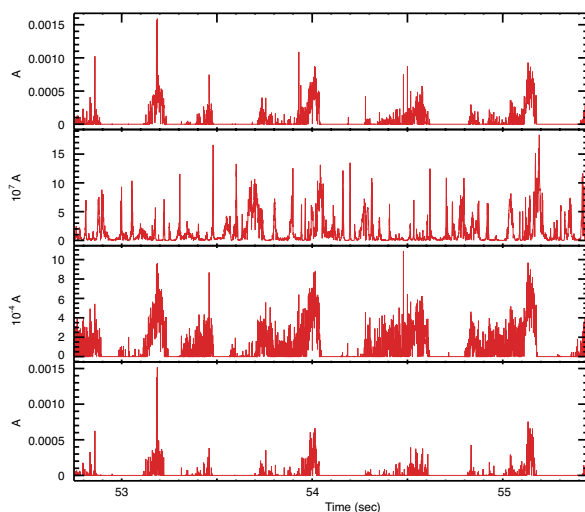

Figure 9. Lost fast-ion signal from Faraday cup array during ICRF heating.

KSTAR

Construction of the Korea Superconducting Tokamak Advanced Research (KSTAR) device in Taejon, South Korea, is nearing completion. Consequently, the U.S.-KSTAR collaboration is approaching a time of change. At the U.S.-KSTAR meeting at Princeton in September 2006, the American and South Korean teams agreed that the U.S. will complete the current research and development program by the end of FY07 and that the deliverables will be presented at the FY07 U.S.-KSTAR meeting in Taejon in September 2007. PPPL's contribution during FY06 included incorporating the NUBEAM code into TRANSP and continuing support for diagnostic cassette design.

Stellarator

PPPL international stellarator collaborations give PPPL researchers access to the world's leading stellarators before the completion of the U.S. National Compact Stellarator Experiment.

PPPL continued its collaboration with the Wendelstein-7 Advanced Stellarator in Germany with analysis of parametric scans of high-beta data. The PIES code analysis capabilities were improved to include the parallel current flowing in the stochastic region, as determined by the equilibrium reconstruction using magnetic diagnostics. The magnetic-field-line diffusion coefficient was calculated in the stochastic edge regions for comparison with the changes in the plasma transport.

Collaboration on the imaging of edge turbulence in the TJ-II, a “flexible” Heliac (stellarator) located at the CIEMAT Institute in Spain, continued with analysis of data on the 2-D gas puff images of edge blobs. Again, this work is an example of the cross-cutting nature of PPPL’s collaborative research. Since the personnel involved are the same as those performing similar measurements on Alcator C-Mod and NSTX, direct comparison of edge turbulence among stellarators, spherical torii, and conventional tokamaks will easily be made.

Collaboration on the Large Helical Device (LHD) in Japan and with the Max-Planck Institut für Plasma-physik-Greifswald included participation in the International Working Group for Confinement Studies in Stellarators. A collaboration effort was established with the National Institute of Fusion Science in Japan on the gyrokinetic modeling of stellarators.

JT-60U

The collaboration with the Japan Atomic Energy Research Agency (JAERI) on the JT-60U tokamak continued to focus on negative-ion neutral-beam development for ITER. Two new problems of relevance to ITER beam development, as well as present and future negative-ion beam operations, were identified. These problems are:

- During beam extraction, a significant fraction of the cesium in the ion source discharge is atomic,

rather than ionic, as would be predicted by standard Saha theory. While ionic cesium is electrostatically prevented from escaping through the plasma grid apertures, atomic cesium is not, and may constitute an unexpected loss term for ITER operation.

- During each period of observation, the ion source plasma was found to contain significant amounts of oxygen. This is a concern because oxygen is twice as electronegative as hydrogen, and thus is many times more prolific in producing negative ions, so the oxygen component of the negative ion population will be much greater than its percentage of total gas in the chamber. It will be extracted with the negative hydrogen. Since it is much heavier than the hydrogen, its space charge will displace hydrogen in proportion to the square root of the mass ratio in the extracted beam (square root of 8 for deuterium, square root of 16 for hydrogen). This may account in part for the perpetually low negative hydrogen and negative deuterium current densities extracted in existing systems. It is believed that the oxygen is stored in the cesium used in these sources, being gradually released as the hydrogen reduces the cesium oxide. The primary source of the oxygen could either be earlier air leaks, earlier water leaks, oxygen coming from the stainless steel in the beamline, or oxygen leached from the insulators.
-

Lithium Tokamak Experiment

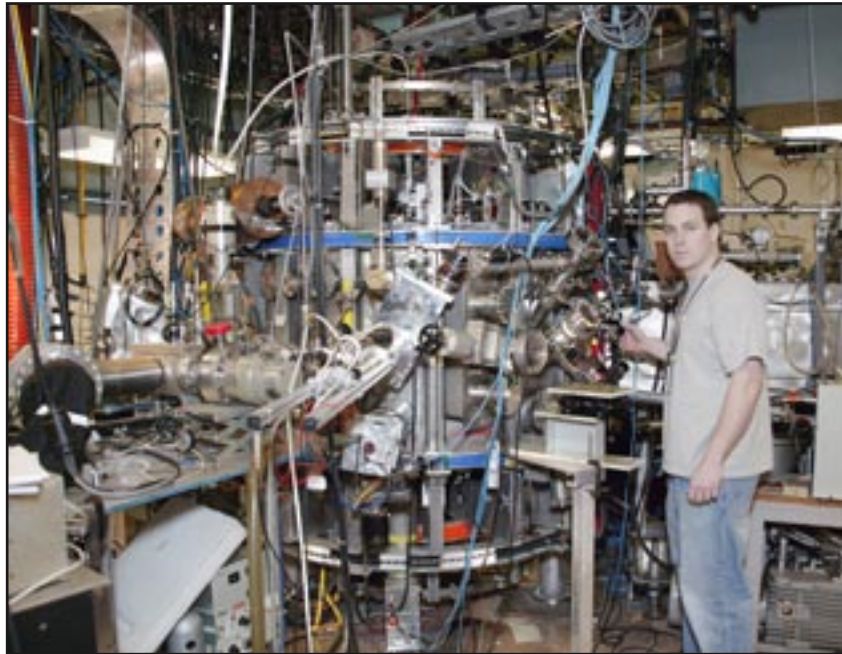

Lithium Tokamak Experiment

The Lithium Tokamak Experiment (LTX) and its predecessor, the Current Drive Experiment-Upgrade (CDX-U), are devices dedicated to the study of liquid lithium as a plasma-facing component (PFC). One of the attractive features of a liquid lithium PFC is that it virtually eliminates recycling, or the reintroduction of cold gas back into the plasma from the vacuum chamber walls. This is because lithium has a high chemical reactivity with atomic hydrogen, which is then retained in the PFC. Flowing liquid lithium can also potentially handle the high power densities expected on fusion reactor walls. In addition, lithium has a low Z , so radiation losses should be reduced if there is any sputtering from the PFC.

All major tokamaks have obtained their best performance under low-recycling conditions. If a fully non-recycling wall can be achieved, theory predicts that the basic nature of magnetic confinement will be changed. The temperature and density profiles, and plasma current distributions, would potentially eliminate dele-

rious plasma instabilities. Furthermore, the transport mechanisms causing the loss of energy and particles would be reduced, and plasmas with higher energy confinement could result.

Suppression of Plasma Instabilities with Liquid Lithium

The CDX-U device was a spherical tokamak with a 34-cm major radius. The torus had an ellipsoidal cross section, with a minor radius of 22 cm and an elongation of 1.6. The plasma current was driven inductively using an Ohmic-heating solenoid in the center column (centerstack) of the machine. It had a maximum value of 100 kA, which could be sustained for about 20 ms.

A unique feature of CDX-U was a large pool of liquid lithium in a tray that completely encircled the bottom of the vacuum chamber. The tray, which had a major radius of 34 cm and width of 10 cm, was filled with lith-

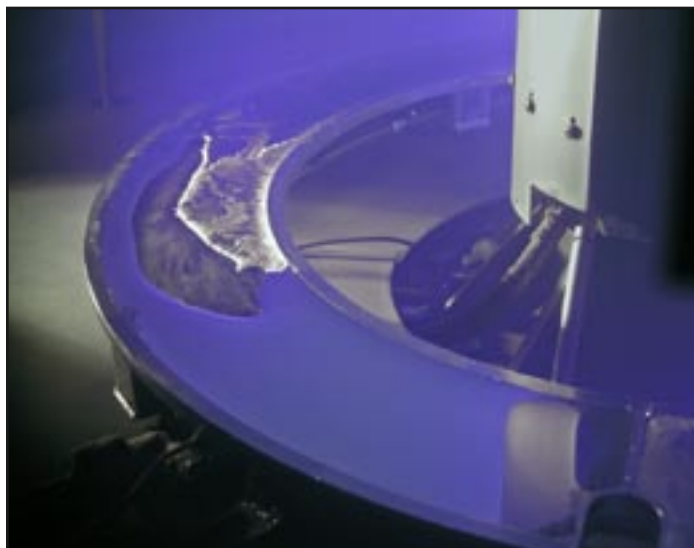

Figure 1. View of CDX-U centerstack (at right) and liquid lithium limiter tray during argon glow discharge cleaning operation.

ium to a depth of a few millimeters. This resulted in a liquid lithium “limiter” in contact with the plasma, with a surface area of 2000 cm^2 . Figure 1 is a view through a CDX-U port that shows the centerstack and the lithium filled-tray. The photograph was taken during an argon glow discharge, which was used to clean the lithium surface of impurities.

The experiments on CDX-U with lithium as a PFC were concluded in FY05, and further analysis of the data was conducted in FY06. Among the more conspicuous features of CDX-U liquid lithium limiter discharges was their stability against plasma oscillations called magnetohydrodynamic (MHD) modes. These were common prior to liquid lithium limiter operation. Tokamak dis-

charges are confined by magnetic fields generated by currents flowing in the plasma. Impurities can change the current distribution, for example, since their influx can vary the resistance of the plasma. This distorts the magnetic field, and the resulting plasma instability is called an MHD mode.

Since MHD modes are related to magnetic field perturbations, they can be detected by magnetic pickup coil sensors located around the plasma. The left-hand panel of Figure 2 shows the signal from one of the magnetic sensors for a CDX-U plasma without a liquid lithium limiter. The sensor signal grows until the magnetic field is so distorted that it “reconnects,” or relaxes into its original configuration. The cycle of MHD mode growth

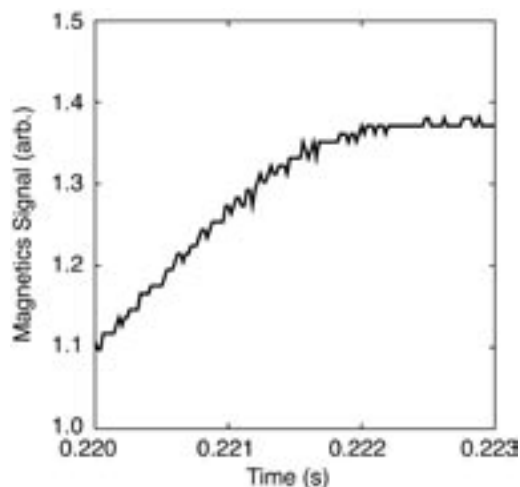
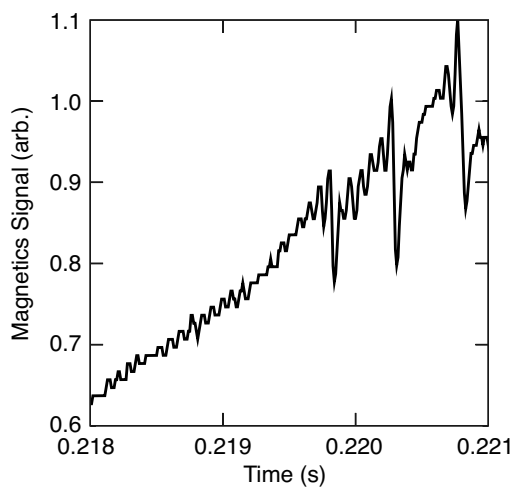

Figure 2. Comparison of magnetic sensor signals for plasma without (left) and with (right) liquid lithium plasma-facing component.

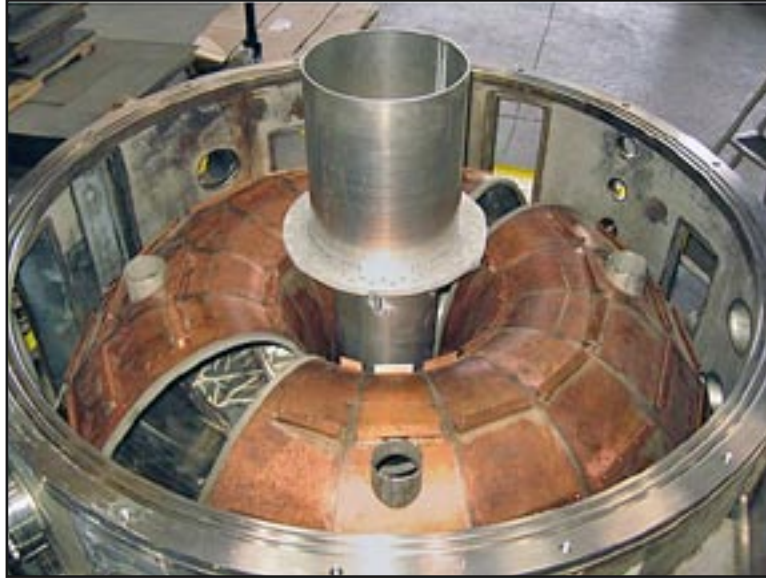

Figure 3. Heated copper inner shell inside former CDX-U vacuum vessel.

and rapid relaxation then repeats in a pattern resembling a “sawtooth.”

With plasmas having a liquid lithium limiter, however, the MHD modes are absent. The right-hand panel of Figure 2 displays the magnetic sensor signal for a CDX-U liquid lithium limiter discharge. On this trace, there is no evidence for the oscillatory behavior associated with MHD modes. This is consistent with suppression of impurity influx into the plasma. The dominant impurity in CDX-U is water, which reacts very strongly with lithium. Its retention in the liquid lithium PFC was demonstrated by the elimination of the water line in the residual gas analyzer spectrum, and the lowest base pressures ever achieved in CDX-U.

Construction and Installation of Heated Inner Shell for LTX

The CDX-U vacuum vessel was disassembled in FY06 to prepare for the installation of a heated inner shell inside it. This was a major step for the conversion of CDX-U to LTX. The shell was fabricated out of 3/8-inch copper sheets, which had a stainless steel liner explosively bonded to it. They were cut, shaped, and welded together into four identical segments. The segments were paired together to form the upper and lower halves of the toroidal shell. In FY06, the fabrication of the shell was completed, and it was successfully installed inside the former CDX-U vacuum vessel (Figure 3).

The upper and lower lids and central tank of the vacuum vessel were also modified (Figure 4). The changes were required to accommodate support structures for the inner shell and access for new diagnostics. These

include a Thomson Scattering electron-temperature system with improved optics and a microwave interferometer that is being upgraded for simultaneous density measurements along two chords through the plasma.

Another diagnostic improvement for LTX will be the detection of ultraviolet (Lyman-alpha) emission to measure the degree of deuterium recycling. On CDX-U, the amount of visible light emitted by atomic deuterium was used to determine how much of it was absorbed by the lithium PFCs. However, the mirror-like surface of the liquid lithium also reflected light from other sources beyond the direct view of the detector. The extra light could lead to an underestimate of the deuterium absorbed by the lithium, and extensive computer modeling was required to correct for this effect. Measuring

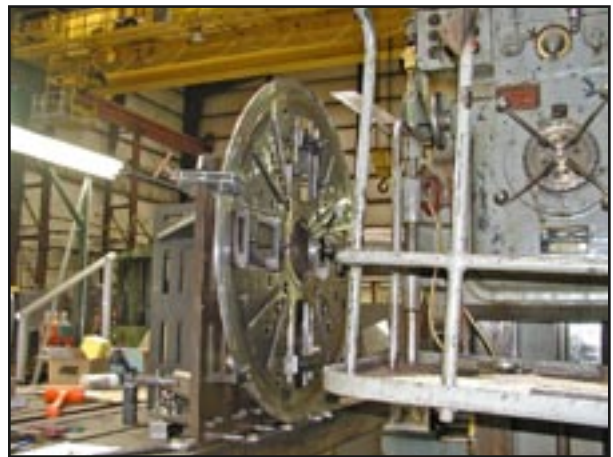

Figure 4. Vacuum vessel lid undergoing modification for LTX.

the Lyman-alpha radiation avoids this problem, since liquid lithium reflects very little ultraviolet light.

The stainless steel plasma-facing surface of the inner LTX shell will be coated with lithium from an electron beam evaporator. The evaporator will be capable of providing a new lithium surface with a ~ 1000 Å thickness between plasma discharges. By keeping the shell temperature above the melting point of lithium, 90% of the PFC area (~ 5 m²) will consist of liquid lithium.

A computer drawing of LTX when completely assembled is shown in Figure 5. The parameters of LTX and CDX-U are compared in Table I. The LTX plasmas will be significantly larger, and their higher currents and longer durations are to be achieved with a new Ohmic-heating power supply. It will consist of larger capacitor banks that are to be controlled with insulated gate bipolar transistors (IGBT's) in an "H-bridge" configuration. This capability did not exist on CDX-U, where the simple discharge of the Ohmic-heating capacitor banks could not result in steady plasma currents. When experiments begin on LTX in late FY07, they will be the first of their kind for the study of plasmas almost fully enclosed by a low-recycling wall.

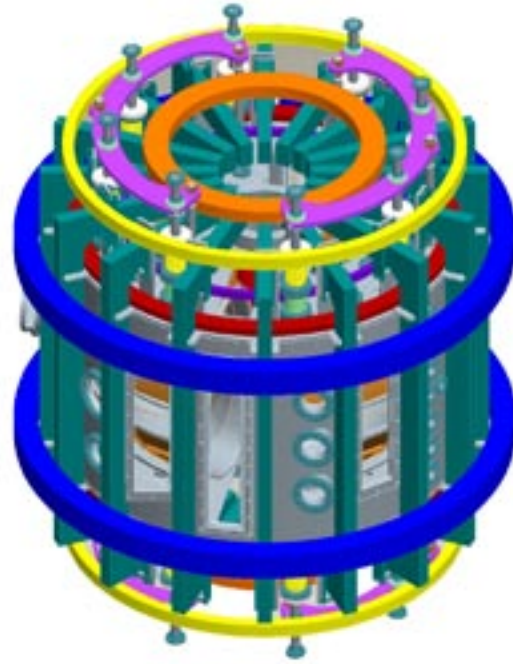
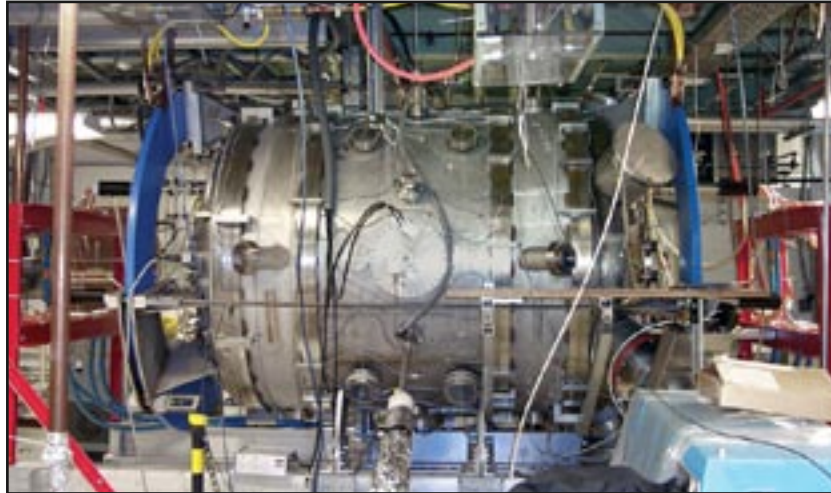

Figure 5. Computer drawing of the fully assembled LTX with cross section showing upper and lower halves of the heated copper shell.

Table 1. Comparison of CDX-U and LTX Parameters.

Parameter	CDX-U	LTX
Major Radius	34 cm	40 cm
Minor Radius	22 cm	26 cm
Toroidal Field	2.1 kG	3.8 kG
Plasma Current	100 kA	250 kA
Discharge Duration	20 ms (transient)	100 ms (flattop)

Magnetic Reconnection Experiment



Magnetic Reconnection Experiment

The Magnetic Reconnection Experiment (MRX), shown above, was built to study magnetic reconnection (Figure 1) as a fundamental plasma process in a controlled laboratory environment. Magnetic Reconnection — the topological breaking, annihilation, and reconnection of magnetic field lines — occurs in virtually all magnetized plasmas, both in the laboratory and in nature.

Despite its omnipresence, reconnection is not a well-understood phenomenon. In laboratory fusion plasmas, such as tokamaks, reconnection manifests itself as “saw-tooth” oscillations in electron temperature and often

affects plasma confinement. Reconnection plays an important role in the evolution of solar flares (Figure 2), coronal heating, and in the dynamics of the Earth’s magnetosphere. Reconnection at the dayside magnetopause is often considered as the onset and triggering of such events as auroral substorms and geomagnetic storms. However, the fast rate of energy release observed during magnetic reconnection is not resolved by the current reconnection models. The observed “fast reconnection” has made magnetic reconnection a very active area of research. Experiments on MRX provide crucial data with which the theoretical and observational research

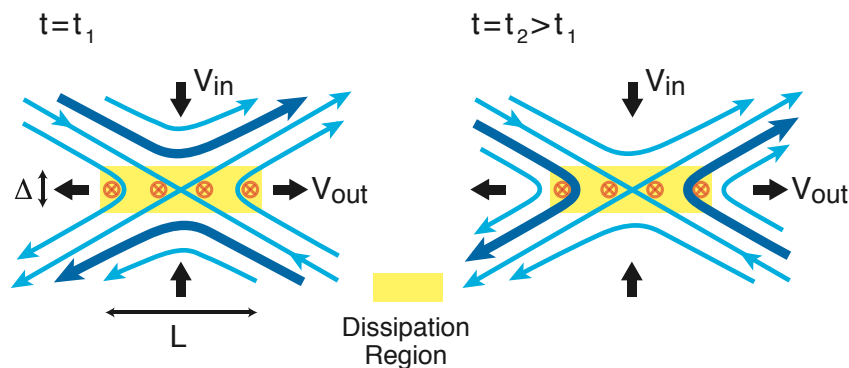

Figure 1. The process of magnetic reconnection. The dark field lines in the left frame move toward the dissipation region and magnetic reconnection occurs. After reconnection, the field lines move into the outflow region, as illustrated in the right frame.

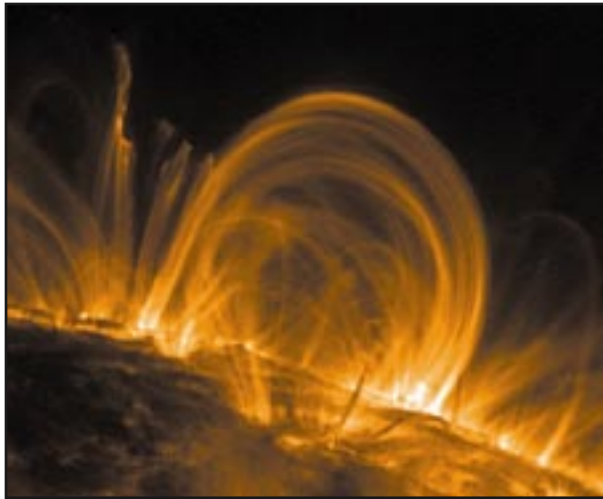

Figure 2. Reconnection in solar flares, illustrated here in data from the TRACE satellite, is thought to lead to the anomalously high plasma temperatures measured in the solar corona.

communities can compare their work. Cross-disciplinary interactions have led to fertile discussions and useful reassessments of the current understanding.

The modest size and versatility of MRX make it an ideal facility to study basic science and to train graduate students. Because of the strong impact of this experiment on many fields of research, MRX is jointly funded by U.S. Department of Energy (DOE), the National Science Foundation (NSF), and the National Aeronautics and Space Administration (NASA).

Research Objectives

The primary purpose of MRX is the comprehensive analysis of magnetic reconnection and related physics, which are crucial for understanding self-organization phenomena of fusion plasmas as well as solar and magnetospheric plasmas. The analysis focuses on the coupling between local microscale features of the reconnection layer and global properties such as external driving forces, MHD flows, and the evolution of the plasma equilibrium. In particular, MRX has the following research goals:

- Test 2-D and 3-D theoretical models of reconnection layers, and compare the results to state-of-the-art numerical simulations.
- Investigate the role of effects beyond resistive MHD (turbulence and Hall-MHD) in determining the reconnection rate and spatial structure of the reconnection layer.
- Explore the role of boundary effects on the rate and spatial structure of magnetic reconnection.

- Identify the mechanisms by which magnetic energy is efficiently converted to plasma kinetic and thermal energy.
- Explore the application of magnetic reconnection science to fusion concepts, including spheromak merging for the formation of large-flux field-reversed configurations (FRCs).

MRX has achieved many important results in the field of magnetic reconnection, and continues to provide high-quality data for comparison with analytic theory, numerical simulation, and space and solar observations. Previous research demonstrated that reconnection in MRX can be accurately modeled using a generalized Sweet-Parker model, as long as the model is generalized to include the effects of downstream pressure and a phenomenological effective resistivity. This effective resistivity, which can be much larger than that caused by simple collisions, provides the enhanced dissipation required to break magnetic field lines. There are many physical processes that can provide the source of this resistivity, and studying these processes is a key goal of MRX research.

Subsequent measurements indicated that substantial magnetic fluctuations can occur at the current sheet center. These fluctuations were shown to be correlated with the enhanced effective resistivity, indicating that they may play an important role in causing fast reconnection. Theoretically, it was shown that the large relative drift between electrons and ions in the current sheet can give rise to electromagnetic waves, and that these waves can lead to enhanced resistivity.

Further research also yielded the first-ever measurement of the Hall effect in a laboratory plasma, by studying the quadrupole out-of-plane magnetic field. The Hall effect is due to the decoupling of electron and ion motions in the vicinity of the reconnection region. This decoupling allows the ions to avoid passing through the center of the reconnection layer, enabling fast reconnection. The decoupling also leads to currents in the plane of magnetic reconnection, which produce the quadrupole out-of-plane field. It is important to note, however, that the Hall effect cannot cause the dissipation required to break magnetic field lines: the reconnection rate can be determined by the Hall effect, but a full physics understanding requires a further examination of the detailed region where magnetic field lines are broken.

Experimental Device

The key components of the MRX device are two flux cores: doughnut shaped devices containing multiple magnet windings that inductively produce the plasma

and magnetic fields in MRX. These flux cores allow two distinct magnetic reconnection geometries in MRX. In the geometry that has been utilized most frequently to date, plasma is formed around the cores, and then the currents in the windings are quickly decreased. This has the effect of pulling oppositely directed magnetic fields together, causing magnetic reconnection to occur and a current sheet to form. This geometry causes long-lived and stable current sheets, allowing detailed study of reconnection physics. The flexibility of this configuration is further enhanced by the ability to form current sheets with a guide-field (co-helicity), or without a guide-field (null-helicity). In the second type of configuration, the programming of the currents in the flux-cores is changed so that two independent toroidal plasmas (spheromaks) are formed adjacent to the flux cores, and then allowed to merge via their mutual attractive force. Magnetic reconnection occurs during this merging, and a fusion relevant field-reversed configuration is formed.

A set of carefully chosen diagnostics provides insight into the physics of magnetic reconnection and real-time monitoring of MRX plasmas. These include Langmuir probes (electron density and temperature, and plasma flows), spectroscopic probes (ion temperature and flows), magnetic probes (spatial and temporal structure of the magnetic field) and large pick-up loops (global currents and magnetic fluxes). Of particular interest for the FY06 operations was the construction of new fine-structure magnetic probe arrays, which allow the small-scale structure of the reconnection layer to be studied, and the manufacture of additional magnetic-fluctuation probes, allowing the extended study of the possible role of small-scale waves in determining the reconnection rate.

Highlights

MRX activities in FY06 focused on three research areas. A campaign of experiments made further studies of the “fine-structure” of the diffusion region, yielding the first ever identification of the electron diffusion region in a laboratory plasma. Second, a related set of experiments measured magnetic fluctuation in the out-flow region of the current sheet. These experiments confirmed that, as with the previous measurements at the $Z = 0$ current sheet midplane, the magnetic fluctuation amplitude is peaked in the current sheet center. As the year ended, MRX had begun a campaign of ohmic sustainment of FRC plasmas.

Identification of the Electron Diffusion Region

As noted above, previous research at MRX has identified the quadrupolar structure of the out-of-plane mag-

netic field in the diffusion region. Research in FY06, utilizing additional fine-structure magnetic probes, enabled a more fine-scale measurement of these structures. An example of the improved measurements of the out-of-plane field are illustrated in Figure 3, where colors represent the out-of-plane magnetic field and the arrows represent the in-plane Hall currents which give rise to that field. Measurements were performed on only the left half of the diffusion region, enabling finer spatial resolution.

Two lobes of the quadrupole field structure are visible, extending away from the current sheet central region; the ridges of these lobes are traced with a dashed red line. These ridges terminate on the corners of a box, which is located at the center of the diffusion region. This box represents the newly identified electron-diffusion region, where the magnetic field lines are broken from the electron fluid, and the final steps in the process of magnetic reconnection take place. Note that the in-plane current pattern, which is mostly indicative of electron flow, shows the electrons traveling along the outer ridges of the separatrices, and then flowing into the diffusion region. The electrons are then accelerated out of the diffusion region in a narrow jet located between the lobes of the out-of-plane field, as indicated by the longer arrows around $R = 0.36$ m. These results indicate the first time that the electron diffusion region, where magnetic field lines are decoupled from the electron fluid, has been identified in a laboratory plasma.

The scaling of the electron diffusion region size has been studied as a function of controllable plasma

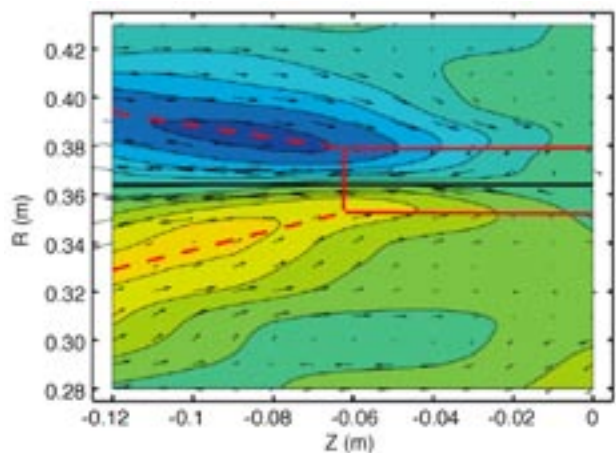

Figure 3. Fine-scale measurements of the electron diffusion region. The colors correspond to the out-of-plane magnetic field, while the arrows indicate the in-plane current that produced the field. The image displays only half of the diffusion region (i.e., measurements in only the left half of Figure 1).

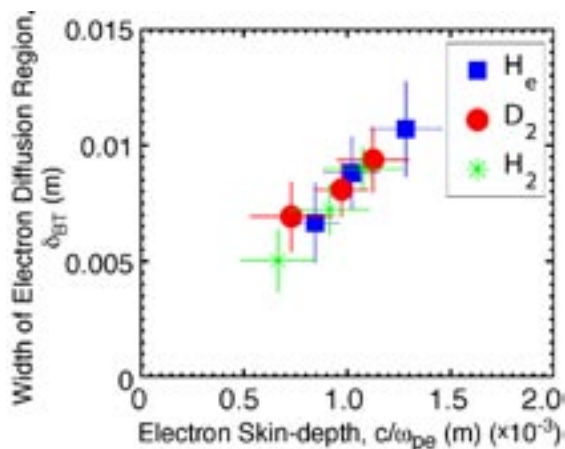

Figure 4. The width of the electron diffusion region as a function of the electron skin-depth. The results indicate that the width of the electron diffusion region does not depend on the ion mass.

parameters. Figure 4 illustrates that the (radial) width of the outflow jet scales with a quantity known as the electron skin-depth, c/ω_{pe} , for plasma formed in different gasses. This result indicates that the ion mass is not a relevant parameter in determining the size of this small inner region, a critical result that will enable the refinement of theories and numerical simulation.

Observation of Magnetic Fluctuations in the Outflow Regions

As indicated above, the Hall effect cannot provide the dissipation required to ultimately break magnetic field lines, although it can accelerate the reconnection process. Magnetic fluctuations, and their associated anomalous resistivity, can provide this dissipation. If there is a large difference between the velocities of electrons and ions, magnetic fluctuations can be excited. Figure 4 illustrates that such a situation exists in the electron outflow regions between the lobes of quadrupole field: the electron flow is very large there, while the ions are nearly stationary. Hence, experiments were conducted to examine magnetic fluctuations in the outflow region during magnetic reconnection.

A typical result from these studies is shown in Figure 5, where the results are plotted as a function of the radial distance from the current sheet center. Frame (a) ($Z = -8$ cm) corresponds to an axial location far from the current sheet midplane, while (b) ($Z = 4$ cm) illustrates measurements nearer to the midplane. The dashed lines represent the current density in both the toroidal (j_T , neutral sheet current) and axial (j_z , outflow) directions; these currents naturally have their maximum value at the current sheet center. Each point represents the amplitude of magnetic fluctuations for a given dis-

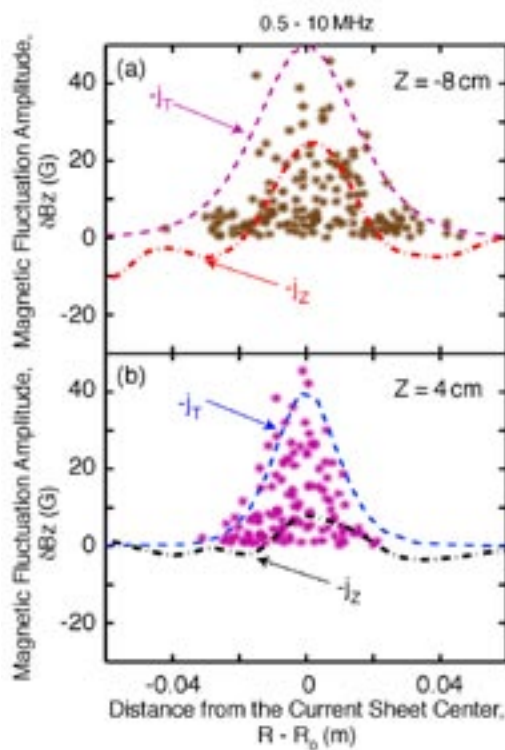

Figure 5. The amplitude of magnetic fluctuations, plotted as a function of the distance across the current sheet, at two locations in the outflow region. The axial (j_z) and toroidal (j_T) current densities are also shown. The results indicate that the largest fluctuations, when they occur, are always located near the center of the current sheet in the region of largest current density.

charge, with many points corresponding to many discharges. The location of largest magnetic fluctuations always occurs near the current sheet center, where the current density is highest. The presence of many discharges without large fluctuations illustrates the intermittent nature of these events: diagnostics located at one location may measure large fluctuations, while other diagnostics may not observe any fluctuations. These fluctuations often coincide with transient increases in the reconnection rate.

These fluctuation studies were conducted while also measuring the quadrupole out-of-plane field. The simultaneous observation of these phenomena illustrates that the quadrupole field, a 2-D phenomenon, can exist in the presence of large magnetic fluctuations, 3-D phenomena. Both are likely important in obtaining a full picture of the magnetic reconnection process.

Ohmic Sustainment of Field-reversed Configuration Plasmas

As FY06 came to a close, a new experimental campaign began, focusing on the sustainment of field-

reversed configuration plasmas using an ohmic solenoid. The ohmic solenoid is a tightly wound helical coil, with a radius of 10 cm, inserted down the center of the MRX device. This helical coil acts as the primary coil of a transformer, while the plasma acts as the secondary coil. Hence, when the current is increased in the ohmic coil, there is a subsequent increase in the plasma current and sustainment of the plasma configuration.

This process is illustrated in the frames of Figure 6, where the top row corresponds to a sustained discharge and the bottom row to a discharge without sustainment. The currents in each flux-core were programmed to form a spheromak; the two spheromaks move toward each other and begin to merge ($t = 275 \mu\text{s}$). At $t = 325 \mu\text{s}$, the merging is complete and an FRC is formed. It is at this point that the ohmic current begins to increase for the sustained discharge, leading to the sustainment of the closed poloidal field lines of the FRC until $630 \mu\text{s}$. The unsustained discharge quickly decays, with field-reversal lost by $t = 360 \mu\text{s}$. The lifetime of FRC plasmas in MRX was extended from $\sim 50 \mu\text{s}$ to $>350 \mu\text{s}$ via this technique.

Future Work

The detailed studies of the Hall effect have been a breakthrough, but further work remains. For instance, the scaling of the fine-scale structures (electron diffusion

region axial length, for instance) with system size is an important theoretical question, which will be addressed in future MRX experiments. Furthermore, the width of the electron diffusion region was observed to be $\sim 8c/\omega_{pe}$, instead of the $1-2 c/\omega_{pe}$ expected based on simulation results. The reason for this discrepancy is related to the issue of anomalous dissipation (and thus possibly magnetic fluctuations), and will be investigated in future experiments.

Future work will also focus on the process of magnetic reconnection in the presence of a guide field (uniform magnetic field perpendicular to the plane of the reconnecting magnetic field). The present MRX physics studies of magnetic fluctuations and the Hall effect will be extended as a function of guide field magnitude, allowing parametric dependencies to be studied. In order to accomplish these studies, an additional coil set and power supply will be constructed.

With regard to FRC studies, the initial success of the ohmic system allows a number of important physics issues in compact toroid physics to be addressed. For instance, what is the mechanism of ohmic current drive in a FRC, where the current flows perpendicular to magnetic field lines? Investigations will also be made of the stability of these configurations, and comparisons will be made between spheromak and FRC plasmas under sustainment.

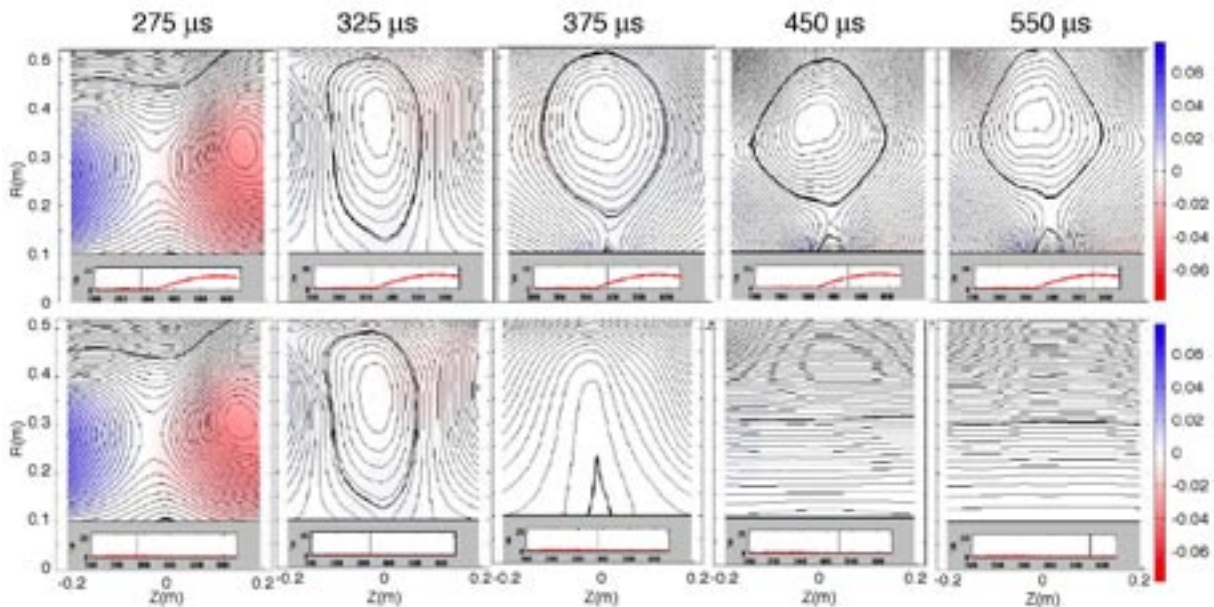

Figure 6. An example of a sustained field-reverse configuration in the top row, and an unsustained configuration in the bottom row.

Plasma Science and Technology

The Princeton Plasma Physics Laboratory has an active program in Plasma Science and Technology which supports the Laboratory's mission to create new knowledge in plasma science and to use this knowledge to develop new plasma technologies. These projects generally consist of small experiments focused on a specific topic of interest. All of these projects have strong graduate and undergraduate participation, and many of them have ties to work being done in the PPPL Theory Department. The Lithium Tokamak Experiment, the Magnetic Reconnection Experiment, and Applications Research and Technology Transfer, discussed elsewhere in this report, form part of this program.

Some of these basic physics experiments lie at the frontiers of fusion research. For example, the novel Field-reversed Configuration Experiment is designed to create a remarkably efficient magnetic confinement system which could eventually be used to burn advanced fusion fuels, while the heavy ion fusion research aims to create and focus extremely high-intensity ion beams onto an inertial fusion target. These and all the other small experiments are strongly coupled to plasma physics research at other national laboratories and universities.

These experiments also have an important role in creating links between plasma physics and other areas of science and technology. For example, the work on high-intensity accelerators is directly applicable to future experiments in high energy physics, and the Hall Thruster Experiment may develop into superior propulsion technologies for spacecraft.

Magnetorotational Instability Experiment

The accretion disks that form around strong gravitational sources such as black holes and protostars are responsible for the formation of stars and planets and for the luminosity of active galactic nuclei, neutron stars, and white dwarfs. To facilitate star and planet formation, the in-falling material must lose a significant amount of angular momentum through turbulent mixing. A rotating fluid disk in equilibrium rotating about a central gravitational source has a Keplerian azimuthal velocity profile $\Omega(r) \propto r^{-3/2}$ with angular momentum increasing with radius. Such an arrangement is hydrodynamically stable according to the Rayleigh criterion ruling out linear instability. Two possible mechanisms for the turbu-

lent transport are then either a nonlinear hydrodynamic instability or a magnetohydrodynamic instability known as the Magnetorotational Instability or MRI.

The MRI is a local instability resulting from the Maxwell stress introduced by an ambient magnetic field coupled to the Keplerian sheared flow. The magnetic stress couples two fluid elements sharing a magnetic field line. If one fluid element is perturbed radially inward toward larger rotation rates, it will experience a loss of angular momentum due to the magnetic stress. The fluid element would then fall further inward. The other fluid element perturbed radially outward will gain angular momentum thereby pushing it farther outward. The instability is suppressed if the magnetic field is too strong to be stretched or if the resistive diffusion rearranges the magnetic field faster than the flow distorts it.

The MRI is sufficiently generic that it should be manifest in an experimental apparatus known as a Taylor-Couette experiment that can generate a quasi-Keplerian flow between rotating concentric cylinders. The MRI experiment, shown in Figure 1, is unique among other Taylor-Couette devices due to the implementation of segmented end-caps that substantially reduce the sec-

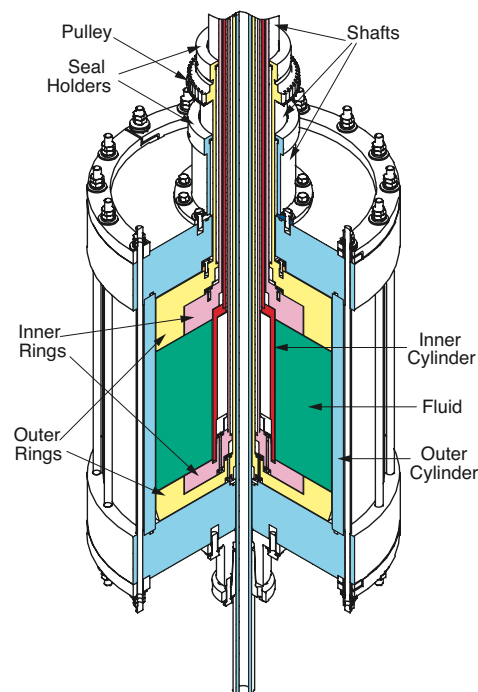

Figure 1. Magnetorotational Instability Experiment.

ondary circulation, known as Ekman pumping, created by the end-caps in a short cylinder. This secondary circulation would otherwise redistribute angular momentum, thus confounding identification of the MRI.

Hydrodynamic experiments using water in the apparatus have demonstrated that the flows generated by rotating cylinders and end-cap rings are essentially laminar for Reynolds numbers up to 2×10^6 . The velocity profile is measured using two-component laser Doppler velocimetry (LDV). The measurements confirm that the flows generated in the experiment are quasi-Keplerian, i.e., the angular velocity decreases with radius whereas the angular momentum increases. The various flows generated in the experiment and referenced in the literature are summarized in Figure 2. In addition, direct measurements of the Reynolds stress due to velocity fluctuations establish that the hydrodynamic contribution to the turbulent angular momentum transport is negligible for the flows produced in the experiment. These results demonstrate that Keplerian flows are both linearly and nonlinearly stable at high Reynolds number. Not only does this create a quiescent background for observing the MRI, but also suggests that hydrodynamic turbulence cannot be responsible for the turbulence in cool disks, such as

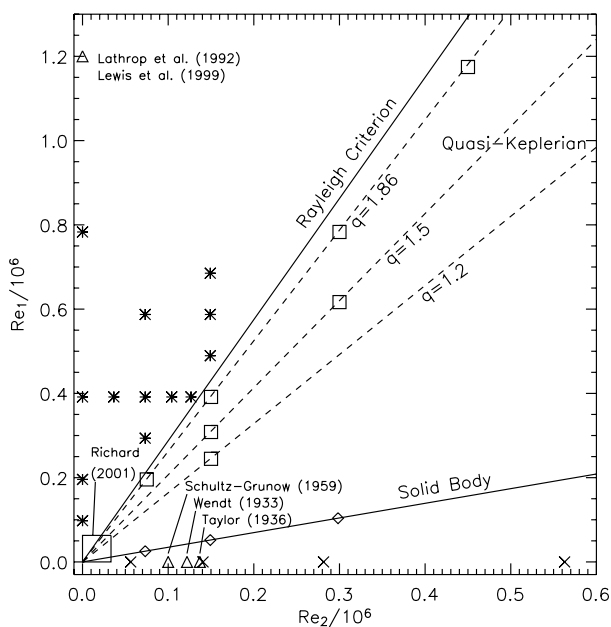

Figure 2. Experimentally studied Taylor-Couette Flows. The two axes are Reynolds numbers based on inner and outer cylinder rotation rates. Asterisks mark Rayleigh-unstable flows, squares indicate quasi-Keplerian flows, and diamonds indicate solid body flows. Crosses indicate flows with the inner cylinder stationary and triangles indicate flows from other experiments in the literature.

the planet-forming disks around protostars, which were thought to be too resistive for the MRI.

The experimental apparatus has been modified to support the introduction of a liquid metal to perform the magnetohydrodynamic experiments. The liquid metal to be used in the experiment is a Gallium alloy that is liquid at room temperature. The viscosity and resistivity of the alloy are sufficiently low to produce the MRI given the flows established in the experiment. The acrylic outer cylinder has been replaced with a stronger stainless steel cylinder. Six magnetic field coils coaxial with the apparatus have been installed and operated up to their designed specification of 1 kA per coil. The coils are capable of creating up to a 0.5-T axial magnetic field to produce the MRI. The initial diagnostics, including arrays of induction coils and Hall probes, have been installed and will be used to observe the magnetic perturbations induced by the instability.

A numerical simulation of the experiment based on the ZEUS astrophysical code is being produced to predict the signal levels expected on each of the diagnostics given the rotation rates of the cylinders and the current in each of the six coils. A hydrodynamic wing has also been manufactured to introduce pressure and magnetic field sensors into the fluid with minimal impact to the flow. The internal measurements will be used to measure the nonlinear saturation of the MRI. A torque sleeve has been proposed to measure the global angular momentum transport produced by the MRI and ultrasonic Doppler velocimetry will be used to measure the velocity profile. A facility for treating oxidized Gallium alloy has also been designed to purify the alloy between experimental runs and to prevent oxidization during operation. Results from the experiment will provide valuable insight into an elusive astrophysical process critical to our understanding of star and planet formation.

Liquid Metal Experiment

Most magnetohydrodynamic (MHD) experiments using liquid metals have concentrated on instabilities and turbulence with closed boundaries. The Liquid Metal Experiment (LMX) is a small-scale laboratory experiment designed to explore the less developed field of free-surface MHD. Surface waves and turbulence are an essential component to processes in both astrophysical and laboratory plasmas. It is thought that energetic events such as X-ray bursts from neutron stars are related to the free-surface flows generated by accretion of material onto the dense plasma ocean on the star surface. Interest in using liquid metals in a first-wall application in fusion devices raises important questions about the stability of a free-surface flow of liquid metal subject to strong magnetic fields and high heat flux. The goal

of LMX is to address the basic physics of MHD open channel flow through experiments using a Gallium alloy that is a liquid metal at room temperature.

Several questions on the basic physics of MHD channel flow will be addressed in the LMX. The effects of the magnetic field on the flow profile have been shown to depend on the aspect ratio of the channel, i.e., the ratio of flow height to width. Experiments using large aspect ratio channels documented in the literature demonstrated flattening of the cross-channel velocity profile with increased transverse magnetic field strength. Previous LMX studies with a small aspect ratio channel, however, showed velocity profile peaking due to a reduction in the influence of the boundary layers on the channel walls. The LMX will be used to study the flow profile as a function of magnetic field, aspect ratio, and flow speed.

Changes to the stability of flow to surface waves will also be explored. Previous results indicate that driven surface waves are not affected by a magnetic field applied in the perpendicular direction of wave propagation while the waves are damped with a parallel magnetic field, in agreement with a linear stability analysis. Further exploration of nonlinear effects such as solitary waves is also planned.

Experiments will be conducted to assess MHD effects on shear stability, namely whether the flow is stabilized by the suppression of cross-field perturbations or destabilized by the introduction of new boundary layers or is subject to critical layer instabilities arising from a matching of the flow speed with the surface wave phase speed. Changes to heat transport due to thermal convection will also be studied by applying both horizontal and vertical temperature gradients.

Collaborators at the University of Chicago and the Argonne National Laboratory have contributed to the theory development of the project and are working on numerical simulations to explore the stability of a free-surface MHD flow. Their results so far have established that the magnetic field can suppress two types of hydrodynamic instability. The first is a long-wavelength propagating surface wave referred to as the “soft” instability. It is suppressed by resistive dissipation when the magnetic field is normal to the flow. An internal “hard” instability present at short wavelengths is suppressed regardless of field orientation.

The construction of a new channel and pump, shown in Figure 3, and a new 7-kG magnet is complete. The new apparatus allows exploration of faster flow speeds and accommodates experiments with either water or the Gallium alloy. Preliminary water experiments were performed to reduce channel entrance and exit effects. Laser Doppler velocimetry measurements shown in Figure 4 demonstrate that the length of uniform downstream

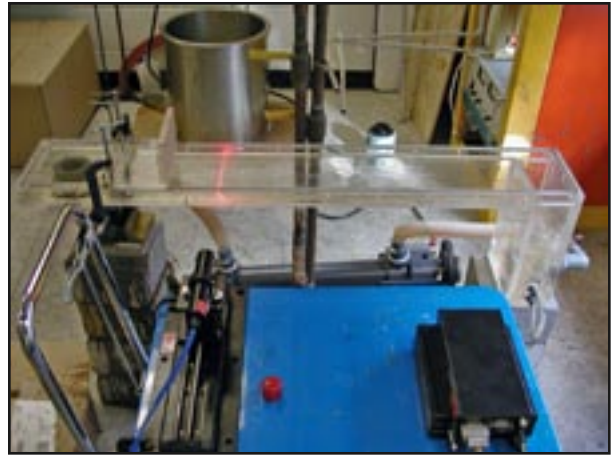

Figure 3. The Liquid Metal Experiment including the channel with pump and the laser Doppler velocimetry system.

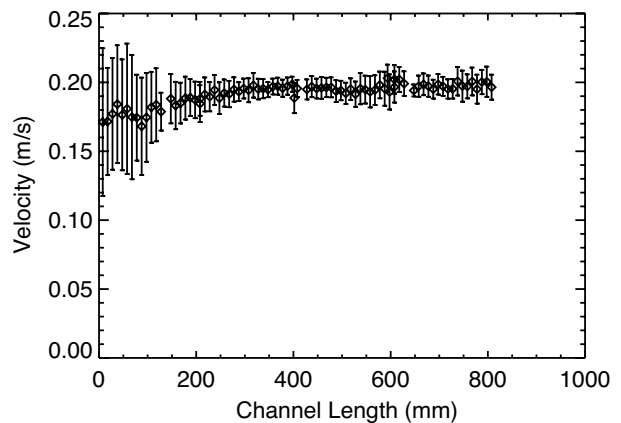

Figure 4. Laser Doppler velocimetry measurements of the downstream velocity along the length of the channel in the LMX.

flow will be adequate for conducting the liquid metal experiments. The upcoming liquid metal experiments should improve the general understanding of free-surface MHD flows and its application to both fusion and astrophysics.

Magnetic Nozzle Experiment

The Magnetic Nozzle Experiment (MNX) studies the physics of mirror-geometry helicon-heated plasmas expanding through magnetic field gradients. Applications of MNX research are to fusion science, solar physics, and spacecraft propulsion. During FY06, a productive collaboration with Professor E. Scime, West Virginia University (WVU), continued and three graduate students — X. Sun (WVU), M. Miah, and N. Ferraro — performed research on MNX.

Scientific studies during the fiscal year included explorations of ion flow speed along the plasma column; these studies were performed with a laser-induced-fluorescence system loaned by WVU. Ion acceleration to supersonic speeds occurs by passage through a double layer formed by mechanical or magnetic apertures placed in helicon plasmas. The high directed energy achieved, about ten times the electron temperature, shows that the double-layer ion-acceleration method has potential for use in spacecraft propulsion missions to remote planets. These results were published in *Physics of Plasmas* [X. Sun, S.A. Cohen, Earl E. Scime, and Mahmood M. Miah, "On-axis Parallel Ion Speeds Near Mechanical and Magnetic Apertures in a Helicon Plasma Device," *Phys. Plasmas* 12:10 (October 2005) Article No. 103509 (8 pages)].

Experiments on the role of superthermal electrons in determining the strength of the double layer were started. Diagnosis of the helicon-heated plasmas was performed with passive emission spectroscopy (interpreted with collisional-radiative models) and Langmuir probes. The results are consistent with a small superthermal population ($E_s \sim 100$ eV and $n_s/n_e \sim 10^{-3}$) being responsible for the strong ion acceleration [S.A. Cohen, Xuan Sun, N.M. Ferraro, E.E. Scime, M. Miah, S. Stange, N.S. Siefert, R.F. Boivin, "On Collisionless Ion and Electron Populations in the Magnetic Nozzle Experiment (MNX)," *IEEE Trans. Plasma Sci.* 34:3, Part 2 (June 2006) 792-803]. Particle-in-cell (PIC) simulations have shown the presence of a superthermal electron component, generated by electron flow up the double layer.

Princeton Field-Reversed Configuration Experiment

The Princeton Field-Reversed Configuration Experiment (PFRC) was built to study the physics of odd-parity rotating magnetic fields (RMF₀) interacting with magnetized plasmas. Theory predicts that FRCs formed by odd-parity rotating magnetic fields should have closed magnetic field lines, hence good energy confinement properties. Other favorable theoretical predictions for odd-parity rotating magnetic fields are excellent ion heating in the ion-cyclotron range-of-frequencies and good electron heating, even far below the electron-cyclotron-resonance frequency. The PFRC was designed to use commercially available equipment and to operate at low power. Both choices improve facility safety and lower facility costs, important aspects to the eventual commercial success of fusion power.

In FY06, five graduate students, J. Olsen, N. Ferraro, A. Roach, D. Lundberg, and D. Fong, performed PFRC research. The research strongly benefited from collaborations with theoreticians at the Los Alamos National

Laboratory (A. Glasser) and the Naval Research Laboratory (A. Landsman).

Theoretical investigations during FY06 were on the mechanism for odd-parity rotating magnetic fields heating of ions. The heating of figure-8 ion orbits was shown to be large compared to that of betatron and cyclotron orbits. Heating occurred at nonlinear resonances of the odd-parity rotating magnetic fields frequency with the ion orbital frequency. The onset and saturation of figure-8-orbit heating was explained. These studies show how it is possible to tune the energy of heated ions, allowing use of a resonance in fusion rates, as exists for the p-B¹¹ fuel mixture [A.S. Landsman, S.A. Cohen and A.H. Glasser, "Onset and Saturation of Ion Heating by Odd-parity Rotating Magnetic Fields in a Field-Reversed Configuration," *Phys. Rev. Lett.* 96:1 (3 January 2006) Article No. 015002].

Results achieved in the experimental program were extraordinarily encouraging. High-beta hydrogen plasmas ($0.6 < \langle \beta \rangle < 0.9$), with a low Coulomb collisionality ($\nu^* < 10^{-3}$) — one-thousand times smaller than previously obtained — were formed using only 10 kW of radio-frequency power applied to a 4-cm radius plasma column. The electron temperatures, measured by both diamagnetic loops and X-ray detectors, exceeded 200 eV, about a factor of four higher than previous odd-parity rotating magnetic fields experiments, even those which employed more than 10 MW of heating power. Full penetration of the odd-parity rotating magnetic fields to the major axis was also observed, representing another major technical advance for the PFRC. Full penetration was attributed to control of plasma and neutral density by two in-line divertors, also a "first" in the FRC/RMF₀ program.

Hall Thruster Experiment

A Hall Thruster is a plasma-based propulsion system for space vehicles. Although the vast majority of satellites worldwide have relied on chemical thrusters, the amount of fuel that must be carried by a satellite depends on the speed with which the thruster can eject it. Chemical rockets have very limited fuel exhaust speed. Plasmas can be ejected at much higher speeds, therefore less fuel need be carried on board. Until the late 1990s, the Hall thruster approach had been pursued most vigorously in Russia; during the preceding twenty years, the Russians had placed about 100 Hall Thrusters in orbit.

In FY99, a Hall Thruster Experiment (HTX) was established at the Princeton Plasma Physics Laboratory. The PPPL effort was the result of a collaborative theoretical research effort with the Center for Technological Innovation at Holon, Israel. This study, initially funded by the U.S. Air Force Office of Scientific Research

(AFOSR), identified improvements that might make Hall Thrusters more attractive for commercial and military applications. After demonstrating state-of-the-art thruster operation, including decreased plasma plume, the project acquired broader support. In addition to support from AFOSR, the program has enjoyed support from the Defense Advanced Research Projects Agency, the New Jersey Commission on Science and Technology, and the U.S. Department of Energy. The facility is pictured in Figure 5.

Hall Thruster Operation

A conventional ion thruster consists of two grids, an anode and a cathode, between which a voltage drop occurs. Positively charged ions accelerate away from the anode toward the cathode grid and through it. After the ions get past the cathode, electrons are added to the flow, neutralizing the output to keep it moving. A thrust is exerted on the anode-cathode system, in a direction opposite to that of the flow. Unfortunately, a positive charge builds up in the space between the grids, limiting the ion flow and, therefore, the magnitude of the thrust that can be attained.

In contrast, in a Hall Thruster, electrons injected into a radial magnetic field neutralize the space charge. The magnitude of the field is approximately 200 G, strong enough to trap the electrons by causing them to spiral around the field lines. The magnetic field and a trapped electron cloud together serve as a virtual cathode (see Figure 6). The ions, too heavy to be affected by the field,



Figure 5. The PPPL Hall Thruster Experiment and research team.

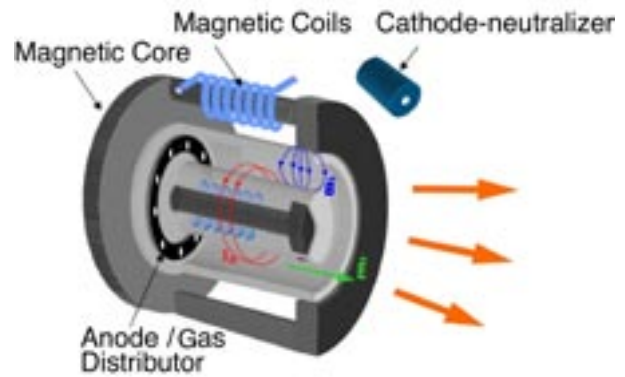

Figure 6. The Hall thruster concept.

continue their journey through the virtual cathode. The movement of the positive and negative electrical charges through the system results in a net force on the thruster in a direction opposite that of the ion flow.

Plasma thrusters for current space applications employ xenon propellant. Xenon is relatively easy to ionize and store onboard the spacecraft. It also has a high atomic number (54), which means a lot of mass per ionization energy expended. The ionization energy is an unavoidable inefficiency, in the range of exhaust velocities most useful for current space applications, about 15 km/sec. The energy loss for once-ionized xenon is less than 10 percent of the exhaust energy. (If the weight per atom were half, this percentage would double.)

Applications

Thrusters are used to compensate for atmospheric drag on satellites in low-earth orbit, to reposition satellites in geosynchronous orbit, or to raise a satellite from a lower orbit to geosynchronous orbit. For each kilogram of satellite mass it turns out that about one or two watts of on-board power are available. Hall thrusters ranging from below a hundred watts to more than 2 kilowatts have been built at PPPL. PPPL physicists hope that their ideas can be useful both for thrusters operating at many thousands of watts, like for planetary missions, as well as, in the small power limit, for very small satellites with masses of 50 to 100 kilograms.

Thruster Results

One of the main innovations at the PPPL HTX facility (Figure 7) was to show how steep voltage drops could be localized and controlled in a Hall-thruster geometry using segmented electrodes. These techniques now support new thruster configurations and new methods to focus neutralized ion beams thereby to achieve significant beam current densities. Experiments on the recently upgraded HTX facility began to challenge accepted limits on the magnetic insulation

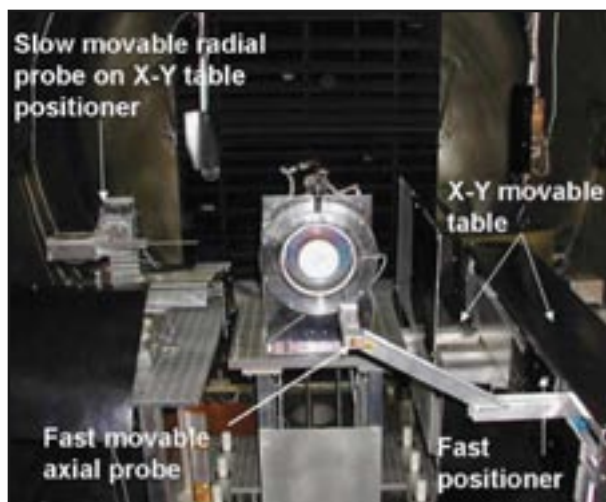

Figure 7. Interior view of the Hall Thruster vacuum chamber.

properties of plasma. With unique plasma probe diagnostics, the importance of plasma-wall interactions and the role of secondary electron emission in power losses at the walls and electron cross-field transport was demonstrated.

In addition to imagining larger, more powerful thrusters capable of accelerating satellites more quickly or powering larger satellites, scientists also envision a large satellite discharging hundreds of smaller ones for the exploration of a planet or as a space-based radar array. The PPPL Hall microthruster was invented to scale to low power. This device employs a cylindrical rather than the conventional annular configuration. Because of its low surface to volume ratio, the cylindrical geometry is better adapted for microthruster operation.

The technological problems associated with scaling to low power are by no means straightforward. The power density tends to grow at small sizes, and the smaller features are more susceptible to heat loading. In attacking these technological constraints, in the cylindrical design, the central magnetic pole is almost eliminated, as shown in Figures 8 and 9.

The cylindrical thruster geometry is fundamentally different from the conventional configuration in the way the electrons are confined in the discharge and the ion space charge is neutralized. Here, the electrons in the cylindrical part of the channel are trapped axially in a hybrid magneto-electrostatic trap: on the anode side they are reflected by the strong magnetic mirror, while on the cathode side they are reflected by the potential drop in the plume. Electrons neutralize the ion space charge not by being held axially by the radial magnetic field, like in the conventional thruster and, instead, electrons are allowed to move axially back and forth while

being trapped axially in the hybrid trap. Therefore, one of the fundamental constraints of the conventional thruster configuration is loosened, and the associated physics of this new thruster is quite different. The PPPL Hall Microthruster has been operating at high efficiency below the 100-W range, useful for very small satellites with masses of 50 to 100 kg.

Several low-power cylindrical Hall thrusters built along the lines of the PPPL thruster were characterized at the Air Force Research Laboratory, Edwards, CA, and at the NASA Marshall Space Flight Center. The thruster

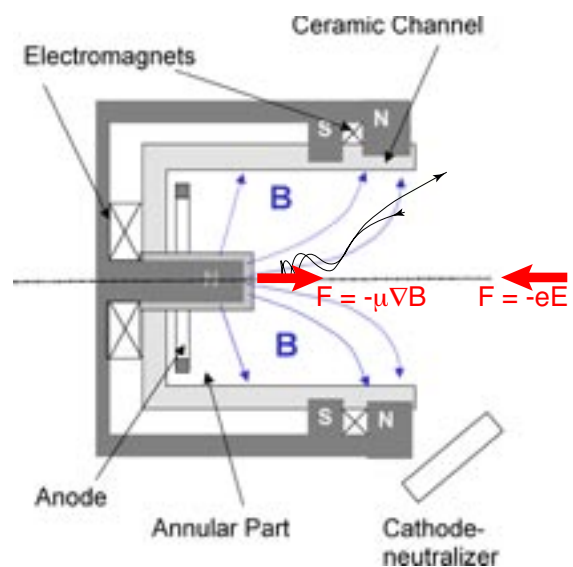

Figure 8. Schematic of the Hall Microthruster with cylindrical geometry.

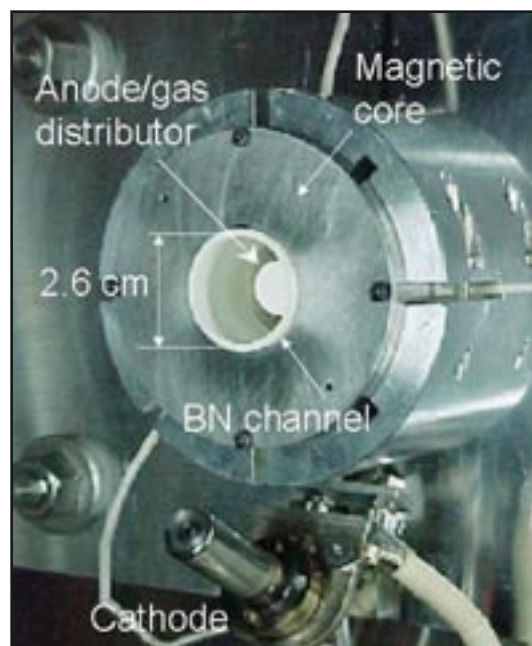

Figure 9. A 100-W cylindrical design Hall thruster.

efficiencies were determined through collaboration with the Mechanical and Aerospace Engineering Department at Princeton University. Because of the larger volume-to-surface ratio, cylindrical Hall thrusters are expected to last longer than conventional Hall thrusters with similar efficiencies. The cylindrical Hall thruster concept pioneered at PPPL has now captured attention in Japan, France, Korea, and Germany.

During FY06, PPPL scientists achieved the further result of 40% plume narrowing, which resulted in an almost 70% increase of the anode efficiency with stable operation in the voltage regime 50–600 V. An anode efficiency of about 40% was achieved in the power range of 100–200 W through optimization of the magnetic field distribution, discharge parameters, and the use of segmented electrodes. These experiments also exhibited the suppression of the electron anomalous cross-field transport. In this significant voltage and power regime, these efficiencies exceed previous state-of-the-art efficiencies for microthruster electrical propulsion.

Nonneutral Plasma, High-intensity Accelerators, and High Energy Density Physics

A nonneutral plasma is a many-body collection of charged particles in which there is not overall charge neutrality. Such systems are characterized by intense self-electric fields and, in high-current configurations, by intense self-magnetic fields. Nonneutral plasmas, like electrically neutral plasmas, exhibit a broad range of collective properties, such as plasma waves and instabilities. The intense self-fields in a nonneutral plasma can have a large influence on detailed plasma equilibrium, stability, and confinement properties, as well as on the nonlinear dynamics of the system.

There are many practical applications of nonneutral plasmas. These include:

- improved atomic clocks;
- positron and antiproton ion sources;
- antimatter plasmas, with application to antihydrogen production;
- coherent electromagnetic radiation generation, including free electron lasers, cyclotron masers, and magnetrons;
- advanced accelerator concepts with high acceleration gradients;
- investigation of nonlinear collective processes and chaotic particle dynamics in high-intensity charged-particle beams; and

- applications of intense ion beams to studies of high energy density physics properties of warm dense matter and heavy ion fusion.

Research on nonneutral plasmas and high-intensity accelerators at PPPL focuses on three areas:

- basic experimental investigations of nonneutral plasmas confined in a Paul trap with oscillatory wall voltages, used to simulate intense beam propagation through a periodic quadrupole field configuration;
- analytical and numerical studies of the nonlinear dynamics and collective processes in intense nonneutral beams propagating in periodic-focusing accelerators and transport systems, with particular emphasis on next-generation accelerators for ion-beam-driven high energy density physics and fusion, spallation neutron sources, and high-energy physics applications of intense charged-particle beams; and
- experimental investigations of advanced ferroelectric plasma sources for intense ion beam space-charge neutralization; experimental and theoretical studies of ionization and stripping cross sections, and multielectron loss events; optimization of negative ion beams for heavy ion drivers; and application of halogen ion-ion plasmas to warm dense matter studies.

Paul Trap Simulator Experiment

The Paul Trap Simulator Experiment (PTSX) is a compact experiment that simulates intense beam propagation through periodic focusing magnetic alternating-gradient transport systems over distances of tens of kilometers by placing the physicist in the frame-of-reference of the beam. The transverse dynamics of the particles in the two systems is the same. Plasmas are trapped for hundreds of milliseconds in the PTSX device, which corresponds to equivalent propagation distances of tens of kilometers. The PTSX device confines cesium ions in the transverse plane by applying oscillatory voltages to the four quadrants of a 2-m-long 20-cm-diameter, segmented primary cylinder. Static voltages, applied on 40-cm-long end cylinders, provide axial confinement of the trapped one-component pure ion plasma. The amplitude and frequency of the oscillating voltage in PTSX correspond to the amplitude and spacing of the magnets in the actual alternating-gradient transport system.

In recent experiments, the transition rate between two voltage waveform amplitudes was varied to establish at what rate the transition may be considered adi-

abatic. A comparison of instantaneous and assuredly adiabatic changes (made over 40 lattice periods) in the applied waveform voltage amplitude shows that 90% changes can be made (Figure 10). Subsequently, it was shown that these adiabatic changes can be made in as few as four lattice periods. This result is corroborated by particle-in-cell (PIC) simulations performed using the WARP particle-in-cell code.

Collective Effects in Bunched Beams

In 3-D high-intensity bunched beams, collective effects with strong coupling between the longitudinal and transverse dynamics are of fundamental importance. A direct consequence of this coupling effect is that the particle dynamics does not conserve transverse energy and longitudinal energy separately, and there exists no exact kinetic equilibrium that has an anisotropic energy in the transverse and longitudinal directions. The strong coupling also introduces a mechanism for the electrostatic Harris-type instability, which is driven by the energy anisotropy and exists naturally for intense beams, to occur. The self-consistent Vlasov-Maxwell equations have been applied to high-intensity bunched beams, and a generalized low-noise δf particle simulation algorithm has been developed for bunched beams with or without energy anisotropy. Systematic studies have been carried out for: the particle dynamics, approximate equilibrium, and stability properties

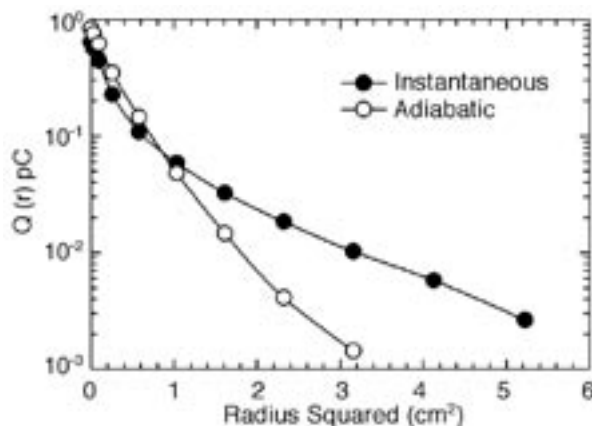

Figure 10. The radial charge profile (which is proportional to the radial density profile) changes from a near-equilibrium Gaussian profile to a profile that has a significant “halo” population of particles at large radii. Here the amplitude was increased by 90%, and “adiabatic” means a transition was made over 40 lattice periods.

under conditions corresponding to strong 3-D nonlinear space-charge forces. Finite-bunch-length effects on the collective excitations and anisotropy-driven instabilities have been investigated. Plotted in Figure 11 are the frequency spectra of collective excitations for different bunch aspect ratios at moderate beam intensity with normalized intensity 0.27. The figure shows that

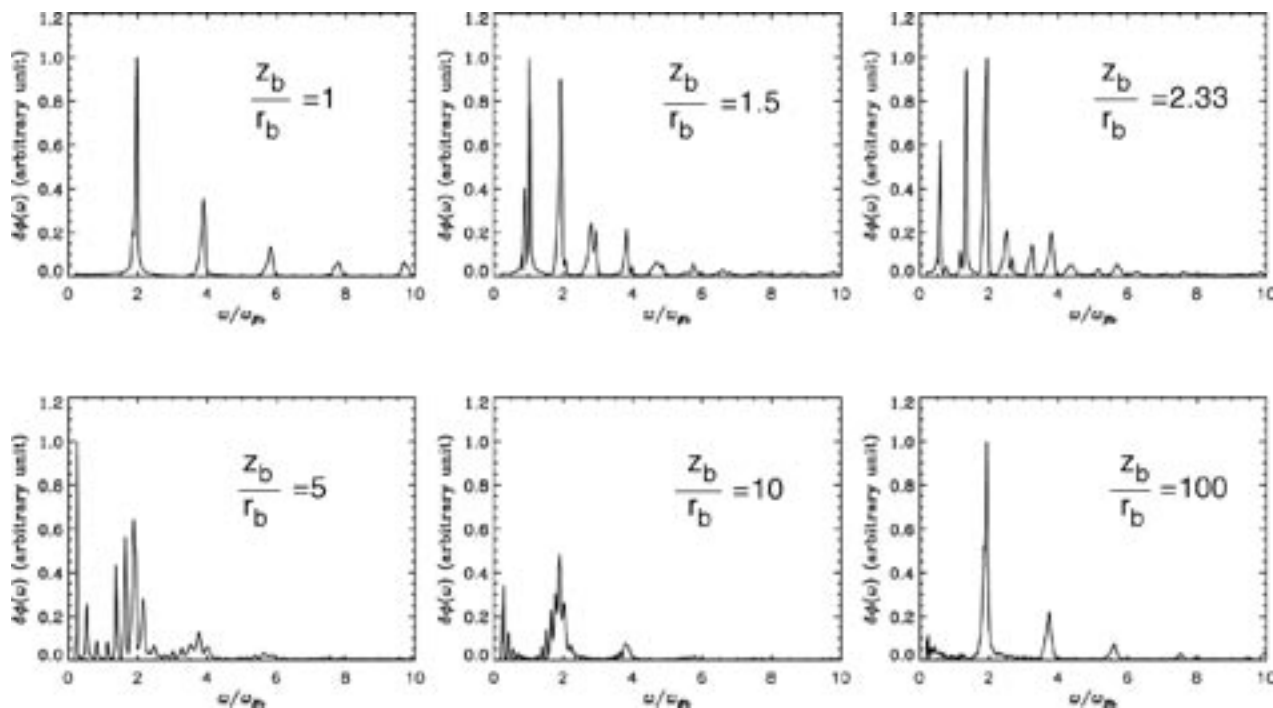

Figure 11. The collective excitation spectra for a moderately intense charge bunch with shape ranging from spherical ($z_b/r_b = 1$) to highly elongated ($z_b/r_b = 100$).

the spectra for a spherical bunch and a highly elongated bunch are similar, and finite-length bunch effects on the collective excitations are clearly demonstrated by the interesting variation of the spectra as a function of the bunch aspect ratio.

Anisotropy-driven Instabilities

Temperature anisotropies develop naturally in accelerators during the acceleration phase. In intense charged-particle beams with large temperature anisotropy, free energy is available to drive the classical electrostatic Harris and electromagnetic Weibel instabilities. A nonlinear δf electromagnetic particle simulation scheme has been developed recently to study the propagation of intense charged-particle beams in high-intensity accelerators and transport systems. The scheme is based on the electromagnetic Darwin model for high-intensity relativistic particle beams.

The model was originally proposed by C.G. Darwin (1920) to retain the lowest-order relativistic corrections through order v^2/c^2 by neglecting the transverse induction current in Ampere's law. The result is the elimination of light waves from the Maxwell-Vlasov equations, which greatly relaxes the time-step restrictions for numerical simulations. Another interesting property of the model is that the resulting Maxwell's equations are now elliptic rather than full-blown wave equations, and the numerical procedures required for solving these equations are different, and the time-step requirement is relaxed. It may be argued that the Darwin model is also valid for highly relativistic beams, if retardation effects are not the important physics at hand.

The use of the Darwin model in particle simulations of plasmas has a long history. However, the presence of the time derivative of the vector potential, $\partial\mathbf{A}/\partial t$, in the equations of motion for the Darwin model can cause numerical instabilities. To circumvent this difficulty, procedures involving the removal of $\partial\mathbf{A}/\partial t$ in the equations of motion have been developed in which the mechanical momentum, $\mathbf{p} = \gamma m\mathbf{v}$ is replaced by the canonical momentum, $\mathbf{P} = \mathbf{p} + (q/c)\mathbf{A}$, as a phase-space variable so as to eliminate the troublesome $\partial\mathbf{A}/\partial t$ term, where q is the charge, c is the speed of light in vacuum, and m is the rest mass. This canonical momentum scheme has been cast into the $\delta f = F - F_0$ formalism, where F is the particle distribution function in phase space, and F_0 is the equilibrium particle distribution function. As a result, the simulation has minimal numerical noise, and also provides us with the ability to easily access both the linear and nonlinear regimes for the physics of interest.

Since the high-frequency waves associated with the radiation fields are absent from the simulations, to simulate low-frequency electromagnetic phenomena like

beam filamentation, a scheme of adiabatic particle pushing is employed in which the particles executing fast betatron oscillations are advanced more often, and with smaller time steps, than those for the electromagnetic fields, which evolve more slowly. This allows the impact of the increased complexity of the field equations on the simulation time to be minimized.

The Darwin scheme described here is ideal for studying such electromagnetic instabilities as the filamentation and Weibel instabilities, which may cause a deterioration of the beam quality. It has recently been shown that beams with anisotropic temperature are susceptible to both the fast electrostatic Harris instability and the slow electromagnetic Weibel instability. In earlier work, detailed studies were carried out of the linear and nonlinear stages of the electrostatic Harris instability using the electrostatic version of the Beam Equilibrium Stability and Transport (BEST) code. The newly developed electromagnetic version of the BEST code allows similar detailed investigations of the electromagnetic Weibel instability to be carried out.

Neutralized Transport

Space-charge-dominated ion beam pulses for warm dense matter and heavy ion fusion applications must undergo simultaneous transverse and longitudinal compression in order to reach the desired high beam intensities at the target. Longitudinal focusing is achieved by imposing an axial velocity tilt on the beam and subsequently neutralizing its space-charge and current in a drift region filled with high-density plasma. A strong solenoid (multi-Tesla) near the end of the drift region to transversely focus the beam to a submillimeter spot size coincident with the longitudinal focal plane is modeled.

The neutralization provided by the background plasma is critical in determining the total achievable compression of the beam pulse. Long-time and large-space-scale plasma flow simulations indicate that adequate plasma densities can be provided throughout the drift region for ion-beam charge neutralization in near-term focusing experiments. Simulations also suggest that a strong solenoid may be partially filled on-axis by injecting plasma along field lines, thereby providing the necessary neutralization during the final focus.

Simulations predict that the ion-beam current density can be longitudinally and transversely compressed over a few meters by factors between 10^3 and 10^5 , depending on the strength of the two focusing elements and the level of neutralization provided by the plasma, with peak beam densities in the range of 10^{12} to 10^{14} cm^{-3} . The peak beam density sets a lower bound on the plasma density required near the focal plane for optimal beam compression, since simulations show stagna-

tion and the generation of strong collective excitations by beam-plasma interactions when the beam density exceeds the plasma density.

Near-term experiments planned for the Neutralized Drift Compression Experiment (NDCX) at the Lawrence Berkeley National Laboratory (LBNL) will examine whether the plasma filling of a high-field solenoid can be experimentally realized. Then, NDCX will seek to achieve simultaneous focusing, to a sub-mm spot radius with a pulse width of a few nanoseconds, using a final-focus solenoid placed upstream of the focal plane.

Optimizing the compression under the appropriate experimental constraints offers the potential of delivering more intensity per unit length of accelerator to the target, thereby allowing more compact and cost-effective accelerators and transport lines to be used as ion-beam drivers.

Plasma Sources and Neutralization Experiments

Researchers at PPPL have developed advanced plasma sources to support the charge neutralization studies conducted on NDCX. To create plasmas that are one-meter long, as required for NDCX, a ferroelectric ceramic plasma source has been built and tested. Barium-titanate ceramic rings, with a relative dielectric coefficient of several thousand, are stacked together to form a one-meter-long, three-inch-diameter, thin-walled cylinder. A 6-kV pulse applied between the outer surface and the inner surface creates a strong radial electric field that is greatly enhanced at the inner surface of the cylinder because of the large relative dielectric coefficient of the ceramic. The ceramic material itself is vaporized at the inner surface and converted into a plasma. Measurements show that plasmas with densities of 10^{10} cm^{-3} and temperatures around 10 eV are created.

Experiments performed on NDCX in which a K^+ beam is allowed to longitudinally compress while drifting through a plasma demonstrate that the ferroelectric plasma source is more effective in allowing the compression than a filtered cathodic arc plasma source (FCAPS). The data in Figure 12 show that, when the ferroelectric plasma source is used, the signal rises from a baseline value near 0.05 V to almost 3.5 V, corresponding to a longitudinal current compression by a factor of 70.

Ionization and Stripping Cross Sections

A classical trajectory Monte Carlo simulation (CTMC) has been used to calculate the ionization and charge-exchange cross sections for hydrogen and helium targets bombarded by many different ions. Despite that the simulation only accounts for classical mechanics, the calculations compare favorably with experimental results for projectile velocities near the maximum cross-

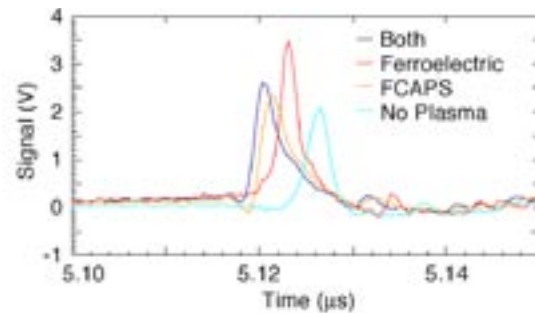

Figure 12. The signal for a beam allowed to compress by passing through a background plasma shows a compression of 70 when the plasma is produced by a ferroelectric ceramic-based plasma source.

section velocity. At higher or lower velocities, quantum mechanical effects become more significant, and the CTMC results agree less well with measured values. Figure 13 shows the comparison of simulation results with the experimental values. Figure 14 shows the predictions for the cross sections of charge-changing collisions in the ion energy range of the Neutralized Transport Experiment (NTX) and the High Current Experiment (HCX) experiments at the Lawrence Berkeley National Laboratory.

Negative Ions and Warm Dense Matter

Work continued this year on the analysis and interpretation of data collected during extraction of negative and positive chlorine beams, as well as electrons, from chlorine plasmas in collaborations with personnel at LBNL and the Lawrence Livermore National Laboratory (LLNL). In the second set of experiments performed at LLNL, these beams were also compared to positive argon beams extracted under similar conditions. The most recent results obtained from these experiments were presented in two invited papers given at international conferences.

The first of these invited papers — “Negative Halogen Ions for Fusion Applications,” by L.R. Grisham, J.W. Kwan, S.K. Hahto, S.T. Hahto, K.N. Leung, and G. Westenskow, *Rev. Sci. Instrum.* 77 (March 2006) Article No. 03A501 — was presented at the International Conference on Ion Sources (Caen, France, September, 2005). This paper focuses on the implications of the chlorine research for heavy-ion-driven inertial confinement fusion and other applications requiring high-brightness negative ion beams. The experiments showed that negative chlorine beams could be produced and accelerated with current densities almost the same as for positive chlorine beams extracted from the same discharge, and also similar to the positive argon current density which could be extracted from an argon discharge

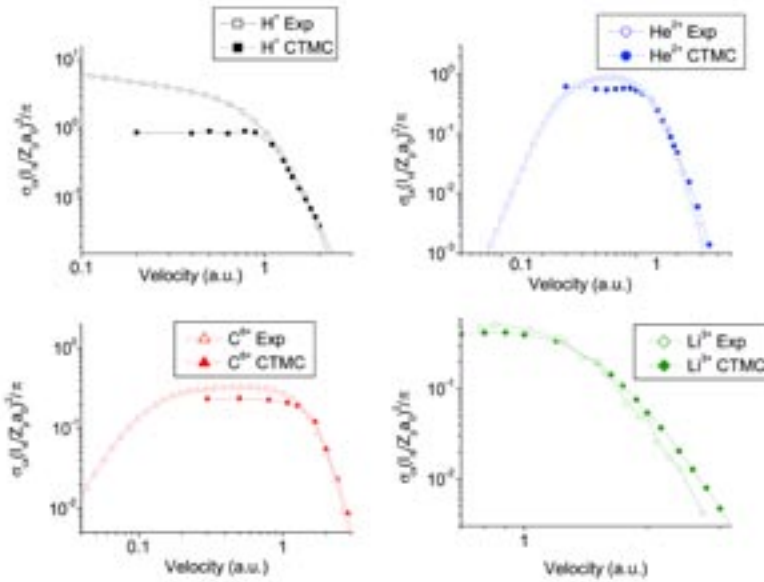

Figure 13. Charge-exchange cross sections of fully stripped ions on hydrogen.

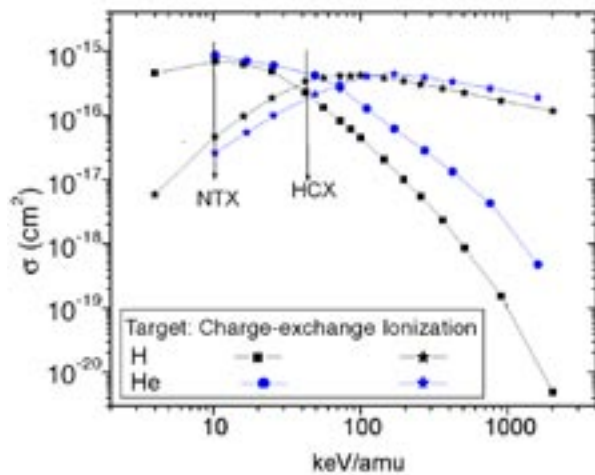

Figure 14. K^+ ionization and charge-exchange cross sections of ions on H and He targets. NTX is the Neutralized Transport Experiment. HCX is the High Current Experiment. Both experiments are at the Lawrence Berkeley National Laboratory.

under similar conditions. The emittances of the negative chlorine, positive chlorine, and positive argon beams were identical within experimental resolution under optimized conditions. Even without the grid-implanted electron-removal magnets ubiquitous in negative hydrogen sources, the co-extracted electron component was remarkably low, due to the production of ion-ion plasma conditions in the source extraction plane. Because all of the halogens form negative ions through similar electron dissociative attachment processes, and because they all have large electron affinities, these results should be generally applicable to the rest of the halogens.

The second invited paper — “Halogens for Negative Ion Beams and Ion-Ion Plasmas” by L.R. Grisham, J.W. Kwan, and G. Westenskow, *Nuclear Instrum. Methods Phys. Res. A: Accelerators, Spectrometers, Detectors and Associated Equipment*, in press (2007), available online 22 February 2007 — was presented at the 2006 International Conference on Heavy Ion Fusion (Saint Malo, France, July, 2006). This paper is primarily concerned with the plasma conditions produced near the extractor planes of the chlorine ion sources in which the experiments were carried out, with the extension of these conditions to the warm dense matter regime and with beam attenuation. Examination of the experimental data showed seven clear lines of evidence that the beams had been extracted from ion-ion plasmas consisting primarily of positive chlorine ions, negative chlorine ions, and only a small minority of electrons. Such mass-symmetric plasmas, in which the positive and negative charge carriers have almost the same average mass, are potentially interesting from the point of view of both basic physics properties and possible applications.

A way to extend ion-ion plasmas into the warm dense matter regime has also been proposed. The method is based on heating a micron-thick iodine or bromine foil (two halogens which are solids near room temperature) with a brief energy pulse, which can probably momentarily produce a nearly electron-free ion-ion plasma in a small volume, with a halo of electron-ion plasma. It is planned to eventually try this using the Bragg-peak heating technique proposed in previous years by PPPL, in which the target thickness is matched to the available heating beam energy so that the beam enters the target

near the high-energy side of the top of the dE/dX peak, and leaves near the low-energy side of the top of the peak. This simultaneously ensures the maximum uniformity of energy deposition, as well as the maximum intensity of energy deposition from the beam.

A further analysis of the relative positive and negative chlorine currents accelerated in these experiments demonstrated that the negative ions had been transmitted with only modest attenuation at low energy through gas line-densities that would be equivalent to traveling many kilometers at the velocities and background pressures in high-energy accelerators. Thus, as would be expected from theoretical considerations, the vacuum requirements for using negative halogen beams in heavy ion fusion applications should be only modestly more stringent than for positive ions with a similar mass.

Diagnostic Development

Electron Bernstein Wave Emission Diagnostic

Spherical torus experiments such as the National Spherical Torus Experiment (NSTX) operate at high values of beta (ratio of plasma pressure to confining magnetic field) and relatively low values of the toroidal component of the magnetic field ($B_T = 0.3\text{--}0.6$ T). In this overdense regime, the electron plasma frequency is significantly larger than the lower harmonics of the electron cyclotron frequency. As a result, electron cyclotron emission (ECE) radiometry can not be used to measure the spatial profile of the electron temperature, as in conventional aspect ratio tokamaks. Measurement of electron Bernstein wave (EBW) emission is not subject to this limitation and therefore is a possible electron temperature diagnostic in NSTX plasmas. Electron Bernstein wave emission also has the potential for local current drive in NSTX and could therefore play a significant role in noninductive current-drive scenarios in NSTX. A challenge for both applications of EBW is that the waves do not propagate in vacuum and must be coupled to and from the plasma by mode conversion to electromagnetic waves.

The NSTX work on the development of EBW electron temperature measurements has focused on two conversion mechanisms: conversion to the extraordinary mode at normal incidence to the magnetic field (B-X conversion) and conversion to the elliptically polarized ordinary mode at oblique angles to the magnetic field (B-X-O conversion). This work has shown that the B-X-O conversion is the more promising approach. Good agreement between the measured and predicted values of the radiation temperature was found for B-X-O conversion in NSTX low-con-

finement mode (L-mode) discharges, but there was a significant discrepancy for high-confinement mode (H-mode) discharges.

More detailed measurements of the spatial structure of the EBW emission were therefore needed to improve understanding of EBW physics. This motivated installation and operation in FY06 of two new, remotely steerable, obliquely viewing EBW antennas to allow detailed mapping of the EBW mode-conversion efficiency as a function of poloidal and toroidal angle. The radiometers connected to these antennas have simultaneously measured 8–18 GHz (fundamental) and 18–40 GHz (second and third harmonic) B-X-O emission. These data have been combined with Thomson scattering electron temperature measurements and EBW ray-tracing modeling to deduce the EBW coupling efficiency. The EBW coupling efficiency and emission polarization have also been mapped as a function of toroidal and poloidal angles for L- and H-mode NSTX plasmas, and the results have been compared to ray-tracing code predictions. In L-mode discharges, coupling efficiencies of 50–100% were measured, in good agreement with the predictions, as shown in Figure 15. However, much lower values of the coupling efficiency than predicted were measured in H-mode plasmas. More detailed studies will be performed in H-mode plasmas in FY07. These experiments will utilize improved antenna steering, a wide-angle survey antenna, and local gas puffs.

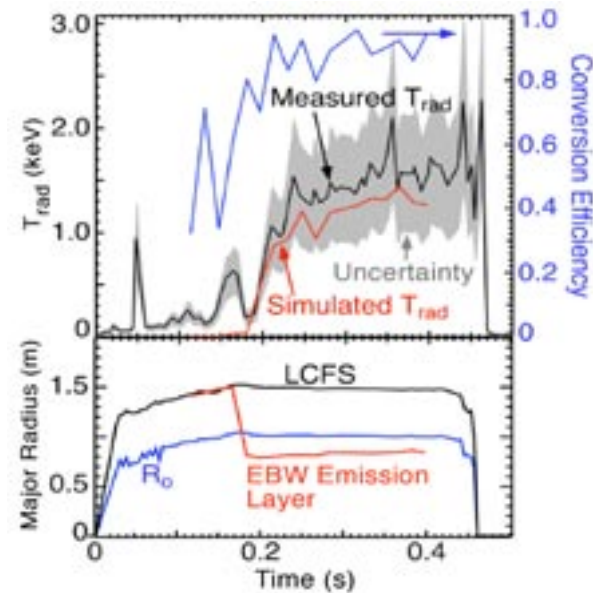

Figure 15. Measured radiation temperature and electron-Bernstein-wave conversion efficiencies show good agreement with calculated values in NSTX L-mode discharges.

3-D Microwave Imaging Diagnostic on TEXTOR

Study of plasma fluctuations via a 3-D microwave imaging diagnostic on the TEXTOR tokamak continued in FY06. This work is being done by a collaboration between PPPL, the University of California at Davis, and the FOM Instituut voor Plasmafysica “Rijnhuizen” in the Netherlands. Electron-cyclotron emission imaging (ECEI) and microwave imaging reflectometry (MIR) diagnostics have been developed to measure temperature and density fluctuations, respectively, with high spatial and temporal resolution. The ECEI diagnostic produces 2-D images of the electron temperature in a poloidal plane with 5 microsecond time resolution. The images consist of 128 channels arranged in a rectangular array with 16 channels in the poloidal direction and 8 channels in the radial direction. Spatial resolution of an individual channel is 1 cm by 2 cm. The system can be configured to image regions on both the high- and low-field sides of the plasma magnetic axis.

The ECEI diagnostic has been used to perform an extensive study of the sawtooth crash phenomenon on TEXTOR. The sawtooth is an $m/n = 1/1$ plasma oscil-

lation involving rapid magnetic reconnection at the crash time. It is commonly seen in tokamak plasmas, but has not been adequately explained by theory. The ECEI diagnostic is ideal for the study of sawtooth physics because the high time resolution allows it to produce many images of the electron temperature during the sawtooth crash, which is typically hundreds of microseconds in duration. This makes it possible to observe the details of the reconnection. Figure 16 shows the development of the characteristic electron temperature hot and cold spots at various times during the sawtooth oscillation.

The ECEI measurements on TEXTOR have shown that the sawtooth is a 3-D randomly localized reconnection process driven by a pressure-driven instability. This study has resulted in two papers published in the journal Physical Review Letters which demonstrate that present theoretical models, including the full reconnection model, the quasi-interchange model, and the ballooning mode model, need to be improved to explain all the observed features of the sawtooth phenomenon [see H.K. Park, N.C. Luhmann, Jr., A.J.H. Donn e, et al., “Observation of High Field Side Crash and Heat Trans-

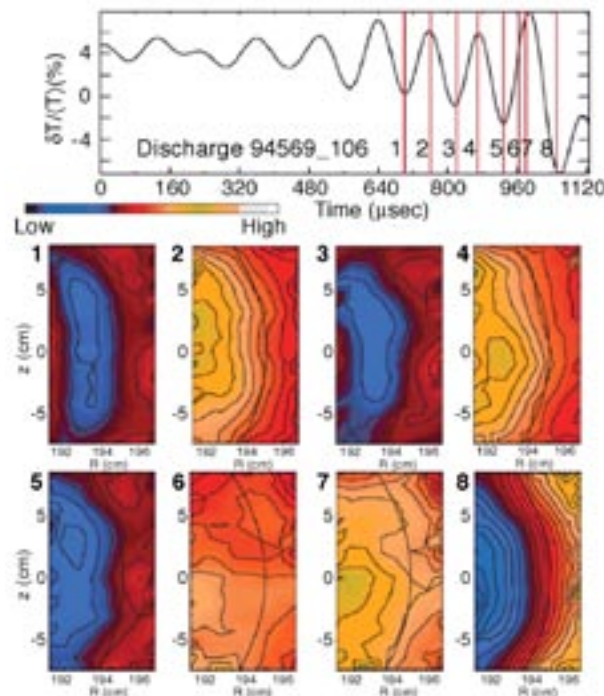

Figure 16. Electron-cyclotron emission imaging (ECEI) diagnostic images during a sawtooth oscillation showing the evolution of the electron temperature hot and cold spots while the plasma is rotating in the toroidal direction. [From H.K. Park, A.J.H. Donn e, N.C. Luhmann, Jr., et al., “Comparison Study of 2D Images of Temperature Fluctuations during Sawtooth Oscillation with Theoretical Models,” Phys. Rev. Lett. 96 (19 May 2006) Article No. 195004.]

fer during Sawtooth Oscillation in Magnetically Confined Plasmas,” Phys. Rev. Lett. **96** (19 May 2006) Article No. 195003 and H.K. Park, A.J.H. Donn , N.C. Luhmann, Jr., et al., “Comparison Study of 2D Images of Temperature Fluctuations during Sawtooth Oscillation with Theoretical Models,” Phys. Rev. Lett. **96** (19 May 2006) Article No. 195004].

Work in FY07 will focus on further development of the microwave imaging reflectometry technique to allow measurement of fast 2-D images of electron density fluctuations.

Imaging X-ray Crystal Spectrometer

Development of an imaging X-ray crystal spectrometer for spatially resolved measurements of the ion temperature, plasma toroidal rotation velocity, and electron temperature continued in FY06. This diagnostic will be well-suited to measurements of these quantities in radio-frequency heating and other experiments in which the perturbation caused by the neutral-beam injection required by charge-exchange spectroscopy measurements is undesirable. Imaging is achieved using the focusing properties of a spherically bent crystal. Previous work using 2-D multi-wire proportional counter detectors demonstrated that the maximum usable count rate was low due to time response limitations inherent in the delay-line readout in these detectors, resulting in poor time resolution of the measurements. One approach to resolving this difficulty is to divide the detector into a

number of smaller segments. This was done in a two-segment detector developed by the Korean Basic Sciences Institute. This detector will be tested on NSTX.

A promising new high count rate detector for this application is the semiconductor pixel array (PILATUS II detector). The size of a PILATUS II detector module is 80 mm by 34 mm and the size of a pixel is 0.172 mm by 0.172 mm. Each pixel has its own readout electronics. As a result, single photon counting at a rate of 1 MHz per pixel can be achieved, making high-time resolution measurements possible. A test of a PILATUS II detector module on an existing X-ray crystal spectrometer on Alcator C-Mod (at the MIT Plasma Fusion and Science Center) successfully recorded the spectrum of Ar^{16+} at 3.1 keV shown in Figure 17. Excellent agreement with the spectrum from a standard multi-wire proportional counter is seen.

It is planned to equip a new X-ray imaging crystal spectrometer on Alcator C-Mod with several PILATUS II detector modules. Due to the high radiation intensity on Alcator C-Mod, it should be possible to obtain spatially resolved Ar^{16+} spectra with good statistics and 10-ms time resolution. These data will provide measurements of the ion-temperature and toroidal plasma rotation velocity profiles and will allow study of plasma rotation in Alcator C-Mod discharges with ion-cyclotron radio-frequency heating. The new spectrometer has been designed and is under construction. Installation and initial operation will take place in FY07.

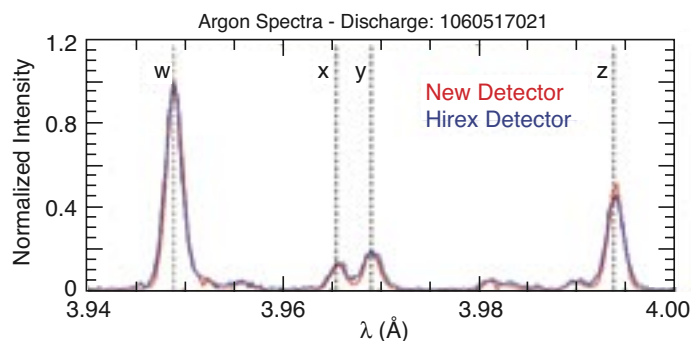

Figure 17. Spectrum of Ar^{16+} (red curve) obtained in a test of the PILATUS II detector on the Alcator C-Mod tokamak. The spectrum obtained with a multi-wire proportional counter detector (blue curve) is shown for comparison.

Engineering and Technical Infrastructure

The Engineering and Technical Infrastructure Department at the Princeton Plasma Physics Laboratory (PPPL) is responsible for managing the Laboratory's engineering resources. This includes a staff of engineers, technicians, and support personnel organized functionally (Mechanical; Electrical; Computer; and Fabrication, Operations, and Maintenance Divisions) to support the Laboratory's research endeavors. The Department is responsible for the technological infrastructure of the Laboratory's experiments as well as the maintenance and operation of the major C- and D-site experimental facilities.

National Compact Stellarator Experiment

During FY06, the National Compact Stellarator Experiment (NCSX) Project made significant progress in the design and fabrication of stellarator core components. Work is being performed in the NCSX Manufacturing Facility set up in the former Tokamak Fusion Test Reactor (TFTR) Test Cell at D-Site.

Modular Coils

The fabrication of NCSX modular coils accelerated during the first half of calendar year 2006 (CY06). Modular coil winding forms are being produced at the rate needed to support modular coil fabrication. By September, seven of the 18 required winding forms were delivered from the supplier, Major Tool and Machine, Inc. The remainder of the forms will be delivered during fiscal year 2007.

Winding of the modular coils (Figure 1) began in late FY05 and will continue through CY07. Improvements were made by PPPL to the manufacturing and winding procedure for the coils during FY06 to reduce the cost and to improve product quality. By the end of CY06 there will be four active turning fixtures, that will be manned two shifts per day to produce the modular coils.

The first modular coil, C1, was tested in the Coil Test Facility in June 2006. Prior to cooling down to cryogenic temperature, a moderate voltage insulation test was performed that revealed a localized weakness in the ground



Figure 1. Fabrication of an NCSX modular coil.

insulation design. The coil was subsequently cooled down to cryogenic temperature and tested at full current without incident. The coil resistance, the observed temperature rise, and the cool-down rate between pulses were all in agreement with predicted values. Displacements across the width of the coil (approximately 2 m) during a pulse were measured with a displacement gauge and were also in excellent agreement (within 2%) with predicted values. Following the test, the C1 coil and all subsequent coils were modified to correct the weakness in the ground insulation design.

Toroidal-field Coils

The design of the NCSX toroidal-field (TF) coils was completed and a production contract was awarded to Everson Tesla Incorporated (ETI) of Nazareth, PA. The NCSX Project provided conductor purchased from

Outokumpu of Finland to ETI. A production facility was set up at the vendor's facility and fabrication of the first TF coil is underway.

Vacuum Vessel

The fabrication of all three NCSX vacuum vessel sub-assemblies (VVSAs) was completed during FY06. When the VVSAs were received, inspections were performed. The dimensional measurements taken at the vendor, Major Tool and Machine, Inc., were confirmed by measurements taken with a Leica laser tracker in the NCSX Manufacturing Facility.

The VVSAs support a large array of magnetic loops (Figure 2) that will be used for plasma reconstruction during operations. Installation of the arrays involves applying a copper template to the outer surface of the VVSA and winding the loop around it. During FY06, the design and fabrication of the templates was completed, and the locations of the loops were marked on the first VVSA.

Heating and cooling of the vacuum vessel shell will be accomplished by circulating gas through flexible hoses clamped to the surface of the vacuum vessel shell. During FY06 design and procurement of the hoses and clamps was completed. Studs were attached to the vessel surface for mounting the clamps on the first VVSA.

Field-period Assembly Begins

During FY06 two turning fixtures were set up in the NCSX Manufacturing Facility for the first stage of

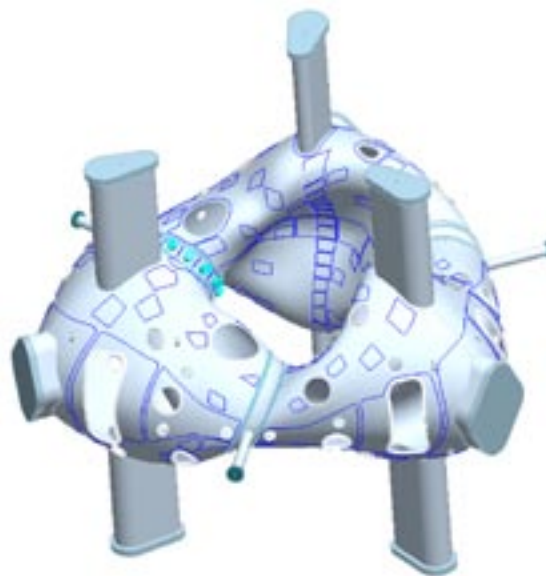

Figure 2. Layout of magnetic loops on the NCSX vacuum vessel.

NCSX field-period assembly. Two of the vacuum vessel segments were mounted in the fixtures where precise measurements of the parts were performed and the cryostat interface flanges were installed (Figure 3).

The first stage of field-period assembly, now underway, involves installation of the vessel heating and cooling hoses, manifolds, and diagnostic magnetic loops. In subsequent stages, the modular coils will be assembled into three coil modules (Stage 2); the modular coils will then be installed over the vessel (Stage 3) (Figure 4); the



Figure 3. The NCSX vacuum vessel subassembly on a turning fixture.

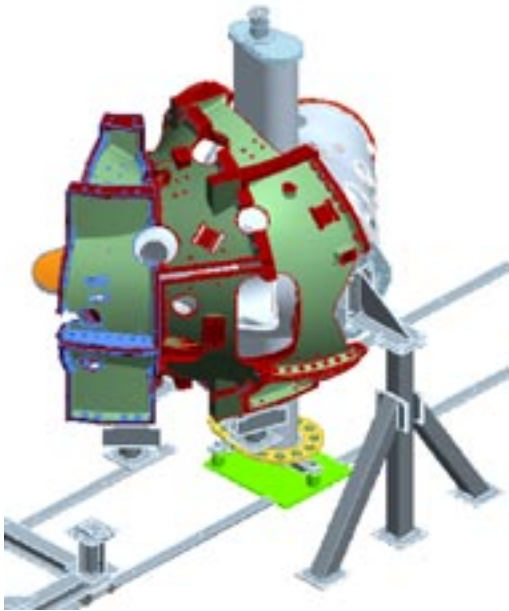

Figure 4. Assembly of NCSX modular coils (green) over the vacuum vessel (light blue) in Stage 3 of field-period assembly.

TF coils will then be assembled into three coil modules (Stage 4); and the TF coils and vessel port extensions will then be installed on a field-period assembly (Stage 5).

During FY06, to determine if clearances were adequate, a Type C-C and B-C modular coil pair were mated to each other on one of the assembly fixtures. Measurements were taken to determine if the coils could be positioned precisely enough to meet the tight NCSX requirements. The trial fit-up verified the models and identified some minor clearance issues that were easily corrected.

National Spherical Torus Experiment Engineering Operations

The FY06 National Spherical Torus Experiment (NSTX) experimental run period began in late February 2006, completing 12.66 run weeks by the end of June. During this period there were 506 hours of high-power operations with technical subsystems operating at an average availability of 94%. There were 1,932 plasma attempts, resulting in 1,617 plasmas.

NSTX operations included extensive use of the new lithium evaporator (LITER), routine toroidal-field operations to 5.5 kG and coaxial helicity injection operations to 1.75 kV. A radio-frequency voltage feedback system was commissioned and resulted in improved high harmonic fast wave heating system control and power delivery. The neutral-beam injection (NBI) system ran reli-

ably through the period at power levels to 7.4 MW at 100 kV, with pulse lengths from less than 10 msec to nearly two seconds.

Upon completion of the experimental campaign, several of the toroidal-field coil flag joints were dismantled for inspection and found to be unaffected after extended operations at higher fields. Also a molybdenum NBI duct bellows shield was designed and constructed that will allow the NBI system to be used more effectively in calibrating the motional Stark effect diagnostic during the next experimental run period.

NSTX Construction

The scheduled outage of NSTX began at the end of July 2006 and is scheduled for completion at the end of January 2007. The main purpose for the outage is to install the poloidal charge-exchange recombination spectrometer diagnostic to enhance the capabilities of NSTX. During FY06, a new port was installed in the Bay-K nozzle for a future diagnostic, and the sightline for the far-infrared tangential interferometer and polarimeter diagnostic was improved by trimming some of the in-vessel tiles.

ITER

Engineering activities during the first part of CY06 focused on preparations for the U.S. Department of Energy's (DOE) Office of Science cost and schedule review of the U.S. ITER Project in February. Following the announcement of the move of the U.S. ITER Project Office to the Oak Ridge National Laboratory in February, PPPL engineers provided support for Project activities and planning.

During the February cost review, PPPL engineers, serving as the acting-managers for the U.S. ITER contributions for the cooling water systems and steady-state electrical power systems, presented the scope, schedule, cost and risks associated with these systems. These findings were based on PPPL and industrial studies performed in FY05. PPPL engineers also supported the U.S. ITER diagnostics cost review led by PPPL physicists. PPPL engineers provided estimates for residual gas analyzers, port plugs, and structures.

Throughout the year, a PPPL mechanical engineer supported the International ITER Team's ongoing preparations for the blanket and shield module attachment, remote handling and port and vessel interfaces. These activities are aimed at refining the design and procurement package documentation. Another PPPL senior mechanical engineer was part of the ITER technical delegation that visited India to assess that country's capabilities for ITER participation. This engineer also organized a laboratory and industry workshop that per-

formed a comprehensive review of the materials for the central solenoid conductor jacket material.

Computing

Scientific and Engineering Computing

PPPL's primary computing resources for scientific and engineering applications are four Linux clusters that provide cost-effective mid-scale serial and parallel computational capabilities to Laboratory researchers and fusion community collaborators. The main cluster was brought into production in April 2006. It consists of 180 dual CPU systems, each linked via 1-GB ethernet connections to very high-performance switching hardware. This cluster is exclusively used for parallel computing jobs. A 24-system high-performance, low-latency cluster was installed in August 2005 and uses a very high-speed (10-GB) switching network for inter-process communication, speeding parallel jobs. A 32-system cluster has also been brought online to provide resources for serial (single-system) jobs. The fourth cluster is a set of 10 systems providing interactive 32 or 64-bit computing for general purpose tasks. Users are allocated to these systems using a least-loaded algorithm. Demand for these clusters has steadily increased.

Off-site researchers are making use of PPPL computing resources, most notably via the FusionGrid TRANSP computational service, with several thousand jobs run in FY06. Although these serial runs use only a small percentage of the overall capacity of the cluster, the availability of the service is important to its users, introducing an off-site sensitivity to the reliability of the system. TRANSP now also provides a "parallel TRANSP engine" on the kestrel cluster that allows TRANSP runs to off-load parallel processing to the engine, speeding execution.

Computing Infrastructure

The 12-TB storage array brought online in July 2004 has grown to 49 TB of storage, and has proved to have exceptionally high performance and reliability. This array provides storage for linux, unix, windows, and VMS systems.

The PPPL network has been upgraded with a new core router providing better reliability and security features. More 1-GB ethernet ports have also been deployed, providing better performance for critical server systems.

Backup of desktop systems is now accomplished in-house using Veritas Netbackup. Using Netbackup, daily backups consisting of all data on a disk can be offered at a much faster rate. A new disk-to-disk backup approach deployed in FY06 has sped up backups considerably. Desktop disks are backed up to high-performance, low-cost disks on the storage area network, instead of directly to tape.

Patch management and the automatic pushing of software updates to domain users were major accomplishments in FY05. In FY06, PPPL migrated to Windows Server Update Service (WSUS) to provide comprehensive patching for all Windows software such as Office products, in addition to the operating system patches. Group Policy was used to install and maintain Windows security settings and some application software. For Macintosh users, Apple Remote Desktop has been implemented to centrally manage some software applications and patching.

Cyber Security

PPPL had no detected cyber security breaches during FY06, which marks a milestone of six years without a cyber security break-in. A few systems, primarily visitors connecting already-infected personal laptops to the PPPL network, were detected with viruses and worms. The effort to keep worms, viruses, trojan horses, spyware, and other malicious software off of PPPL networks continues to be significant. Much effort in the cyber security area has been targeted at addressing cyber security alerts, installing the latest patches, and ensuring that all users have the latest virus protection.

In FY05, two DOE cyber security audits and reviews were performed including detailed internal and external vulnerability scanning and penetration testing and evaluation of PPPL's compliance with the Federal Information Security Management Act and the National Institute of Standards and Technology. Based on gap analysis performed early in FY06, a significant effort began in early FY06 and will continue into FY07 to meet the new requirements.

PPPL initiated a Network Registration system creating 20 Virtual Local Area Networks (VLAN's) for segmentation. Visitor networks were created for both wired and wireless connections. The visitor networks have no connectivity to the PPPL internal network. The Network Registration system requires all workstations to be registered prior to using PPPL network resources. Only authorized PPPL account holders have access to the internal network.

The wireless network was upgraded in FY06. The new wireless network provides for detection of rogue (unauthorized) wireless networks, strong Wi-Fi Protected Access (WPA) encryption capability, VLAN support and better coverage of the Laboratory.

A Virtual Private Network (VPN) appliance from F5 Networks was tested and successfully deployed in the final quarter of FY06. The VPN increases the level of cyber security when accessing PPPL network resources from off-site. The VPN eliminates the need for PPPL firewall authentication, provides high-level encryp-

tion for all transmitted data and uses SecurID 2-factor authentication. The introduction of the VPN service mitigated vulnerabilities in accessing PPPL from Network Address Translation internet connections such as hotels and conference centers.

Increased emphasis on internal cyber security and insider threats has resulted in several initiatives for improvement. Almost all Windows systems now have basic security policy and patch updates managed by the PPPL domain, so that future vulnerabilities can be patched more efficiently. Enforcement of the new policy, which requires all Windows systems at PPPL to be managed by the PPPL domain unless specifically exempted by supervisory approval, is increasing. Redhat Linux clusters now boot from a central server allowing for uniform cyber security policy and simple patching. Most Mac OS systems are being managed via Apple Remote Desktop. PPPL began a program of internal vulnerability scanning using standard software packages. Periodic scans of all computer systems, dial-in modem systems, and wireless networks are done, and known vulnerabilities are identified and addressed.

Laboratory AC Power Systems

PPPL implemented a four-tier electrical safety program this year to formally establish the training requirements for operating, testing, and troubleshooting the var-

ious voltage classes of electrical distribution equipment used at the Laboratory. Also, a major refurbishment of PPPL's 138-kV switchyard was completed, replacing the aging incoming 138-kV linebreaker switch with a new model meeting current safety standards, and restoring the Laboratory's high-voltage transmission tower.

Technical Shops

When Princeton University closed the Forrestal Machine Shop, 28 pieces of machinery were donated to the PPPL technical shops. Included were four large machines (two horizontal mills, a vertical mill, and a large grinder) that will significantly increase the capabilities of the Laboratory's shops.

Work-for-Others

Under a Work-for-Others (WFO) contract with the U.S. Naval Research Laboratory (NRL), the PPPL Engineering and Infrastructure Department designed a plasma exhaust fuel recovery system for use in an inertial fusion energy reactor (Figure 5). The Naval Research Laboratory is the host site of the High Average Power Laser Program. Although the ignition of deuterium-tritium fuel in inertial fusion energy devices is different than magnetic fusion energy devices, the need to recover unexpended fuel, post detonation, from plasma exhaust is critical to the success and efficiency of the technology.

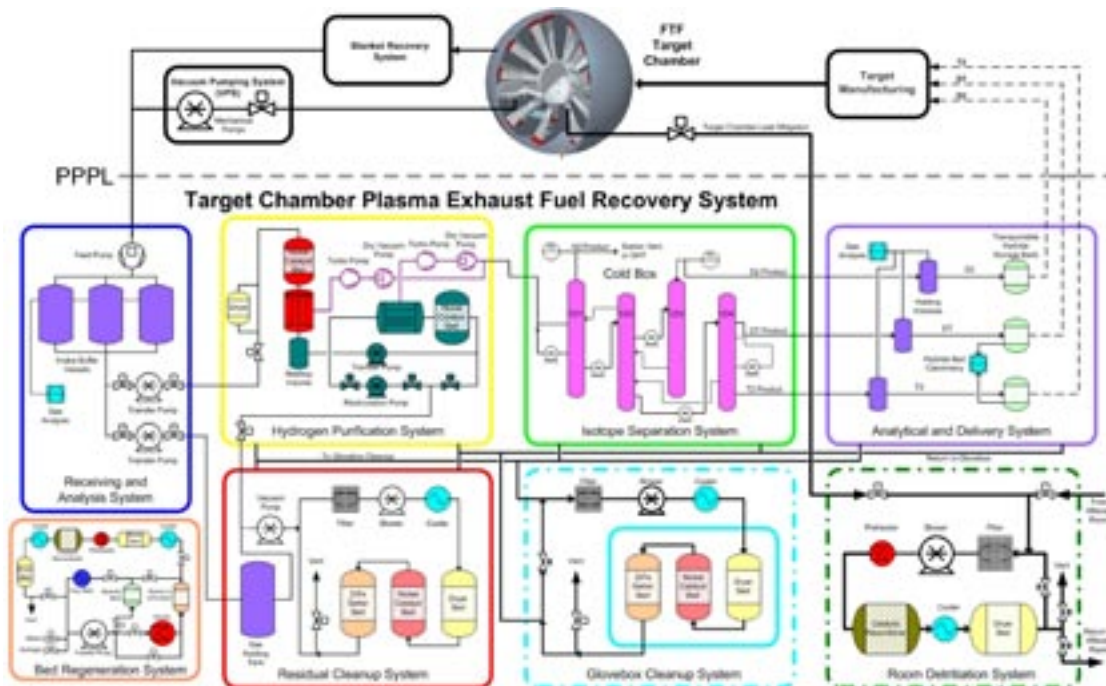

Figure 5. Schematic of the fuel exhaust recovery system designed by PPPL engineers for an inertial fusion energy reactor for the U.S. Naval Research Laboratory.

Environment, Safety, and Health

Princeton University and the Princeton Plasma Physics Laboratory (PPPL) enthusiastically support the U.S. Department of Energy's (DOE) commitment to worker safety at the DOE Laboratories. The safety of every one of our staff, faculty, students, and guests is taken very seriously. Safe operation is of paramount importance; PPPL continually works to improve safety performance. The Laboratory supports the challenging goals that the DOE Office of Science has established, and is implementing strategies to accomplish them.

Worker Safety and Health

During the October 2005 to March 2006 period, PPPL experienced only two Occupational Safety and Health Administration (OSHA) recordable injury cases, neither of which required days away from work or restricted duty. Outstanding safety achievements during this time included:

- Five consecutive months worked without a recordable case.
- Four consecutive months worked without an occupational injury case.
- Seventeen consecutive months (November 23, 2004 through May 4, 2005), more than 1.2 million hours, worked without a "Days Away, Restricted or Transferred" (DART) case.

The number of injury cases increased in the second half of FY06, with six recordable injury cases, two of which were DART cases. The two DART cases required the injured workers to miss work. PPPL endeavors to learn from accidents and incidents that have occurred here and elsewhere both within and outside the DOE complex. Reports on these cases are published on the PPPL Lessons Learned website for viewing by all Laboratory employees, and are automatically e-mailed to all PPPL supervisors. The trend of Recordable injuries is depicted in Figure 1 and the subset of DART injuries is shown in Figure 2.

In March 2006, the Laboratory learned that it had earned several safety awards from the State of New Jersey for performance in Calendar Year 2005 (which included part of FY06. They are:

- PPPL — *Citation of Merit Award* for having no away-from-work lost-time injury or illness cases.
- NCSX Project — *Citation of Merit Award* for having no away-from-work lost-time injury or illness cases.
- NSTX Project — *Commissioner's Continued Excellence Award* for having gone five consecutive years without an away-from-work lost-time injury or illness case.

In addition to current efforts, ongoing or planned PPPL initiatives to further reduce injury cases includes: (1) providing Human Performance Improvement Training for Senior Laboratory Management and for the Environment, Safety and Health and Infrastructure Support (ES&H/IS) Department early in FY07; (2) assessing Laboratory programs to DOE's Voluntary Protection Program certification, and (3) preparing and submitting a new Worker Safety and Health Program description

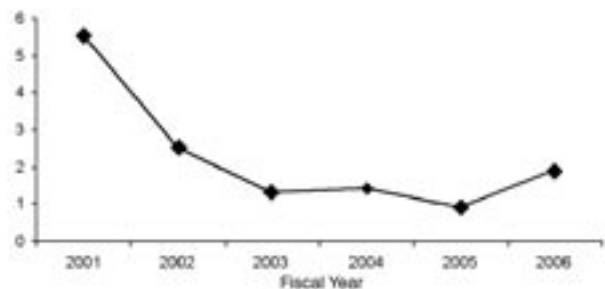

Figure 1. Recordable injuries per 100 employees per fiscal year.

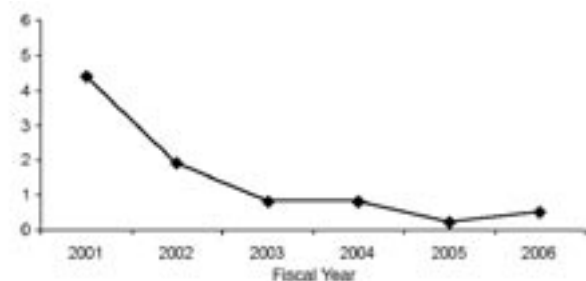

Figure 2. DART (Days Away, Restricted or Transferred) injuries per 100 employees per fiscal year.

to DOE to meet the requirements of a new federal rule pertaining to worker safety.

PPPL continued to develop, improve, and present its hazard awareness training course to PPPL staff (including all levels of management up to and including the Laboratory Director), graduate students, and collaborators. The goal of this course is to train staff to identify and mitigate hazards using classroom training and field exercises. The course is built around the PPPL job hazard analysis (JHA) procedure, and includes an exercise that requires participants to collaboratively complete a JHA in a machine shop or welding shop on a simulated work task. Through the end of fiscal year 2006, more than 400 people had received this training (approximately 96% of the PPPL staff), in addition to members of the DOE-Princeton Site Office (including the Site Office Manager), a representative of DOE Office of Science senior management, Oak Ridge National Laboratory employees who are working on the National Compact Stellarator Experiment (NCSX) being built at PPPL, and several groups of undergraduate summer students working at PPPL.

Staff Engagement in the ES&H Programs

PPPL's Annual Safety Forum was held on May 15, 2006. This year's Forum, which was attended by most Laboratory staff members, featured a talk by Shane Bush from the Idaho National Laboratory on "Celebrating the Human Side of Safety." Other activities included a presentation on PPPL safety performance, safety and environmental displays in the Lyman Spitzer Building Lobby, and several breakout sessions where all staff could participate in the discussion of possible solutions

to safety issues that had been raised in small group meetings held just prior to the Forum.

Participation by all staff in the pre-Forum small group meetings and Forum itself was strongly encouraged by the Laboratory Director and management and was very extensive. Much feedback was received and is being acted upon, as it has been for all previous safety forums held since the first one in 2001. This year, more than 50 specific action items were developed and are being implemented as a result of Safety Forum feedback.

During the week of June 12–16, 2006, a team of seven DOE reviewers from both the Chicago Service Center and the Princeton Site Office performed a comprehensive review of the PPPL Integrated Safety Management System. The team reviewed PPPL practices, interviewed a large number of employees, and observed work in the field. There was extensive review of the NCSX Project activities. The results of the review were very positive. The team verified that PPPL has effectively implemented programs and processes for sustaining an institutionalized safety management program that is compliant with DOE requirements. Regarding staff cognizance and engagement in the ES&H Program, the report said, "PPPL and NCSX management have expended significant effort at engaging workers as partners in improving safety and operations."

Environmental Protection

The Laboratory maintained compliance with all environmental permits and conducted all required monitoring and surveillance activities. In addition, new



Jerry Levine reviews the status of PPPL's Safety Program at the Annual Safety Forum held in May, 2006.

Discharge to Surface Water and General Discharge to Ground Water permits were issued for PPPL's lined detention basin. PPPL experienced several regulatory inspections in FY06, all resulting in satisfactory reports and a determination that PPPL was in compliance with the applicable regulatory requirements.

In FY06 the Materiel and Environmental Services Division continued its high level of support to the Laboratory's research mission and its commitment to continuous improvement. Highlights included the implementation of a site-wide Environmental Management System (EMS), significant reductions in energy use in response to the hurricanes of late 2005, extensive beneficial landscaping work and receipt of three environmental performance awards. These awards included:

- DOE's Office of Science presented PPPL with a *Noteworthy Accomplishment* award for its innova-

tive use of bio-based products including hydraulic oils and cleaning products.

- PPPL received an *Honorable Mention* in the annual Facility of the Year award competition sponsored by *Environmental Protection Magazine*. PPPL is one of only two research facilities and the only Federal Facility to receive this honor.
- The New Jersey Department of Environmental Protection and the Association of New Jersey Recyclers presented PPPL with their *2006 Outstanding Achievement Award* for its recycling performance over the past year.

These recognitions represent collaborative efforts by many PPPL organizations and provide encouragement to employees in their efforts to improve the Laboratory's overall environmental performance.

Applications Research and Technology Transfer

The transfer of technology to private industry, academic institutions, and other federal laboratories is one of the missions of the Princeton Plasma Physics Laboratory (PPPL). The Laboratory is currently working with a number of partners in scientific research and technology development. These collaborations can include Cooperative Research and Development Agreements (CRADAs) or Work For Others (WFOs) projects and primarily involve applications of science and technology developed for PPPL's fusion program. In addition to CRADAs and WFOs the Laboratory also uses Licensing Agreements, Personnel Exchanges, and Technology Maturation Projects to promote the transfer of PPPL technology.

A CRADA, which is a contractual agreement between a federal laboratory and one or more industrial partners, enables industry and PPPL researchers to work on programs of mutual interest. Costs and project results are generally shared between PPPL and the partner. WFO arrangements may involve either federal or non-federal partners. The partners pay for the work performed at PPPL. In the Personnel Exchange Program, researchers from industry assume a work assignment at the Laboratory, or PPPL staff may visit the industrial setting. In a Technology Maturation Project, a Laboratory researcher may work on technologies of interest to industry, where further development is required before a formal collaboration can begin. In addition to the above technology transfer mechanisms, the PPPL Technology Transfer Office encourages the development of technologies that are potentially relevant to commercial interests. These projects are funded by PPPL as Laboratory Director Research and Development Program Activities.

The PPPL Technology Transfer Office works closely with the Laboratory's Budget Office and with the Princeton University Office of Research and Project Administration (ORPA). PPPL technology is licensed through ORPA and PPPL inventions are processed through ORPA. The Laboratory works closely with the University for the patenting and protection of PPPL intellectual property.

WFO Projects

Micro-aviation Vehicle Project

The Micro-aviation Vehicle (MAV) project is conducted in support of the U.S. Naval Research Laboratory's (NRL) Micro Air Vehicle Program, which involves fundamental research and development of aerodynamics and airframes for novel concepts in unconventional miniature aircraft design. MAVs generally have a wingspan of less than two feet and weigh less than a pound. These aircraft are expected to perform useful surveillance missions.

Fiscal year 2006 efforts continued on last year's work on the Samara hybrid aircraft concept. The Samara is a stop rotor aircraft that combines the vertical ascent/descent capabilities of a helicopter with the speed and aerodynamic efficiencies of a fixed wing airplane. New enhanced performance of this type of aircraft was explored with Samara II. The improvements included controlled hover ability, simplified stability controls, and a more compact geometry. Efforts also continued on the development of a more robust, controllable, and reliable versions of the Biplane Insectoid Travel Engine (BITE-Wing). New prototypes were built based on the success of the pivoting wing control system demonstrated in earlier models.

The Samara, BITE-Wing (Figure 1) and other new vehicle development efforts are part NRL's ongoing Survivable Autonomous Mobile Platform, Long Endurance (SAMPLE) project. These vehicles are expected to be able to move in two or more of the following modes of locomotion: flight, crawling, hopping, and swimming. They are also expected to carry out extended missions in a variety of environments.

High-average Power Laser Program

In an Inertial Fusion Energy (IFE) device, the need to recover unexpended fuel, post detonation, from plasma exhaust is critical to the success and efficiency of the technology. During FY06, under a WFO contract with the Naval Research Laboratory, which is the host site of the High-average Power Laser (HAPL) program,



Figure 1. Dave Cylinder makes adjustments to the BITE mk 4. This version of a dual wing-pair air vehicle is being developed under PPPL's WFO Micro-aviation Vehicle project with the Naval Research Laboratory. Under this project fundamental research and development of the aerodynamics and airframes for unconventional miniature aircraft design are conducted.

PPPL provided engineering support for the conceptual and preliminary designs for a vacuum pumping system for an IFE target chamber. PPPL was also responsible for the development of a safe and effective tritium system strategy, including a conceptual design package for a closed-loop tritium system for the IFE target chamber plasma exhaust and blanket.

Miniature Integrated Nuclear Detection System

During FY06, PPPL scientists continued development of the Miniature Integrated Nuclear Detection System (MINDS), which is designed to detect and identify specific radionuclides for homeland security applications. Original MINDS development was funded by the U.S. Army's Picatinny Arsenal and has application for use by police, security personnel, the National Guard, the Coast Guard, and other agencies involved in homeland security, homeland defense, as well as transportation rule compliance. In March 2005, Princeton University and InSitech, a small business located in Dover, New Jersey signed a licensing agreement for the commercialization of MINDS.

The MINDS is configured to detect potential nuclear threats from Radioactive Dispersion Devices, such as a "dirty bomb." The objective is to detect and identify nuclear material in transit, such as entering a site, passing through a tollbooth, placed inside of a shipping container, or hidden in other ways, under realistic conditions. A major feature is the ability to compare the energy spectrum of the detected radionuclide with the spectrum of particular radiological materials that might be used in

weapons. MINDS, designed to respond to nuclear signatures at levels slightly above normal background radiation, can be programmed to respond to specific signatures, thus eliminating false positive alarms resulting from the movement and transportation of approved radionuclides, such as in medical shipments. The possibility of false positives is a major concern of security personnel.

An initial proof-of-principle demonstration was performed in August 2002 in which MINDS detected small quantities of radionuclides in a stationary cargo-type shipping container. Additional demonstrations in FY03 showed MINDS' ability to detect similar material in a moving vehicle. In FY04, MINDS was improved with the introduction of a new neural-network-based detection algorithm and a mobile configuration of the system was developed and demonstrated for law enforcement agencies.

In FY05 and FY06, the MINDS library was expanded to include a wider array of radionuclides and improvements were made to the detection algorithms. Also, MINDS was positioned at two locations off-site from PPPL to collect data from the field. One data collection location is shown in Figure 2 where the MINDS detection unit is located at the top of an entrance guard booth. Also, in FY 06 the MINDS was evaluated for use at a major harbor for monitoring cargo containers as they were off-loaded from ships by a crane.

Additional WFO Projects

Title: Sterilization of Liquid Foods

Sponsor: U.S. Department of Agriculture

Scope: The purpose of this project is to develop new pasteurization methods that use radio-frequency waves and microwave heating. These heating techniques used to warm plasma in a fusion device are being tested



Figure 2. PPPL's Miniature Integrated Nuclear Detection System deployed at a guard station.

for pasteurizing raw liquid foods such as eggs, fruit juices, and milk.

Radio-frequency waves offer advantages over the traditional pasteurization method of directly heating raw liquid foods. The direct method often heats foods unevenly, possibly resulting in incomplete pasteurization in lower-temperature regions and in denaturing foods in overheated regions. Using radio-frequency waves in the appropriate wave length may allow pasteurization without heating liquid foods to temperatures that cause food deterioration. PPPL is providing radio-frequency technology support for this project.

Title: Magnetic Reconnection Experiment

Sponsor: National Aeronautics and Space Administration

Scope: A basic plasma physics research facility, the Magnetic Reconnection Experiment (MRX), is used to study the physics of magnetic reconnection — the topological breaking and reconnection of magnetic field lines in plasmas. Scientists hope to understand the governing principles of this important plasma physics process and to gain a basic understanding of how it affects plasma characteristics such as confinement and heating. The results of these experiments will have relevance to solar physics, astrophysics, magnetospheric physics, and fusion energy research.

Title: Korean Superconducting Tokamak Advanced Research, Phase II

Sponsor: Korean Basic Science Institute

Scope: The Princeton Plasma Physics Laboratory is coordinating a U.S. team in supporting the design of the Korean Superconducting Tokamak Advanced Research (KSTAR) device. KSTAR is the flagship project of the Korean National Fusion Program that was launched officially in January, 1996. The KSTAR device will be built at the National Fusion Research and Development Center at the Korean Basic Science Institute in Taejon, Republic of Korea. During FY06, PPPL completed the fabrication, testing, and delivery of a microwave launcher.

Title: Self-consistent Model for Regions of Downward Auroral Current

Sponsor: National Science Foundation

Scope: The objective of this program is to develop a self-consistent understanding of the plasma and field properties of downward auroral currents.

Title: Kinetic Ballooning Instability as a Mechanism for Substorm Onset in the Near-Earth Plasma Sheet.

Sponsor: National Aeronautics and Space Administration

Scope: The objective of this project is to study the onset mechanism of substorms that occur in the near-Earth plasma sheet region of the magnetosphere. Theoretical predictions are being compared with satellite observations to clarify unresolved physics issues.

Title: Pre-eruption Coronal Magnetic Fields and Coronal Mass Ejections

Sponsor: National Aeronautics and Space Administration

Scope: A typical manifestation of coronal mass ejection (CME) consists of formation and expansion of a CME loop and eventual opening up of the magnetic field lines. Since the field opening is a spontaneous energy-releasing process, the energy of the pre-eruption field of a closed configuration must be greater than the open field energy. The objective of this effort is to investigate the energetics and dynamics of the magnetic fields involved. This study will not only provide an understanding of CME physics, but also information about the observable conditions associated with CMEs.

Title: Current Sheet Structure in Near-Earth Plasma Sheet during Substorm Growth Phase

Sponsor: National Aeronautics and Space Administration

Scope: The purpose of this effort is to study the three-dimensional current sheet structure in the near-Earth plasma sheet region during the substorm growth phase by combining the three-dimensional modeling with observations of magnetic field and plasma pressure from the POLAR satellite.

Title: Accretion onto Massive Black Holes in Low-luminosity Galactic Nuclei

Sponsor: National Aeronautics and Space Administration

Scope: Most galaxies in the universe contain supermassive black holes at their centers; yet most galactic nuclei emit very little radiation indicative of active accretion. The purpose of this work is to investigate this issue using low-radiative efficiency accretion flow models including advection-dominated and convection-dominated accretion flows.

Title: Low-power Cylindrical Hall Thruster

Sponsor: Air Force Office of Scientific Research

Scope: This project focuses on the study of Hall thrusters of cylindrical, rather than annular design, with new features such as emissive segmented electrodes and

central localizing of the cathode neutralizer. The key cylindrical thruster concepts were invented and tested at Princeton, but the physics remains far from sufficiently understood. Many phenomena key to the operation of this thruster concept, and incidentally of general importance to the science of insulating plasma flows, are simply not understood at all. Optimization of a cylindrical geometry Hall Thruster, including a cusp magnetic field, requires an understanding of electron transport, ionization, electric potential distribution, waves and instabilities, and discharge stability.

Title: Electromagnetic Full-particle Simulations of the Structure and Stability of the Magnetopause with Velocity Shear

Sponsor: National Aeronautics and Space Administration

Scope: Two-dimensional, electromagnetic particle simulations of the Earth's magnetopause are being performed to study the formation and stability of the magnetopause current layer in regions where there is substantial flow along the magnetopause interface (on the dayside and tail flanks). In particular, geometries considered unstable to the Kelvin-Helmholtz instability are being considered. The results obtained from the simulation model will be compared with space observations in order to improve understanding of the formation and stability of the magnetopause and its boundary layers.

Title: Laboratory Study of Magnetorotational Instability in a Gallium Disk

Sponsor: National Aeronautics and Space Administration

Scope: The importance of magnetic fields has been widely recognized in a class of astrophysical objects called accretion disks. An accretion disk consists of gas, dust, and plasmas rotating around and slowly accreting onto a central point-like object, which can be a star in formation, collapsed stars in binary systems, or super-massive black holes in active galactic nuclei. Rapid angular momentum transport in accretion disks has been an outstanding problem in astrophysics for more than three decades. The magnetorotational instability has been identified as a powerful mechanism to transport angular momentum. The objective of this project is to demonstrate and study this instability in the laboratory for the first time. This work is being performed in close collaboration with the Princeton University Department of Astrophysical Sciences.

Title: Study of Fluctuations in the Lower-hybrid Range in Reconnecting Current Sheets in Space and the Laboratory

Sponsor: National Aeronautics and Space Administration

Scope: The purpose of this project is to comparatively study fluctuations in the lower-hybrid frequency range measured in reconnecting current sheets in both space and the laboratory. Magnetic reconnection is the primary physics process to determine the dynamical responses of magnetospheric plasmas to the incoming solar wind. Understanding physical mechanisms of the observed fast reconnection is a key element of space plasma physics.

Title: Miniature Integrated Nuclear Detection System Algorithm Development

Sponsor: InSitech, Inc.

Scope: The Miniature Integrated Nuclear Detection System (MINDS) is designed to detect and identify specific radionuclides for counter terrorism purposes. In this project PPPL is developing increased detection capability for MINDS identification algorithms.

Title: Development of Physics Modules for a System Code for Fusion Power Plant Analysis

Sponsor: University of California

Scope: This project includes the provision of physics modules, the introduction of new techniques for design point optimization, the integration of the physics modules with other modules, and the development of data management and graphical displays for a new system code to be used in fusion power plant studies.

Title: Engineered Surfaces for the Lithium Tokamak Experiment

Sponsor: Plasma Processes, Inc.

Scope: The use of an engineered surface as a lithium-loaded plasma first wall is being demonstrated in this Small Business Innovative Research (SBIR) Program project. Plasma Processes, Inc. (PPI) will produce an engineered surface of porous molybdenum on the inner surface of a shell or liner designed to be installed on the Lithium Tokamak Experiment (LTX). The shell will be constructed by PPPL for processing by PPI. The completed system will be tested in the LTX at PPPL.

Patents and Invention Disclosures

Patent Issued

Tandem Clapper Air Vehicle

— *David A. Cylinder*

Oxidative Tritium Decontamination System

— *Charles Gentile, Gregory Guttadora, and John Parker*

Invention Disclosures

A General Method for Stacking Thermal Actuators

— *David Cylinder, Christopher M. Spillmann, Banahalli R. Ratna, Brett D. Martin, and Jawad Naciri*

All Metal Center Stack with Transformer for Spherical Torus

— *David A. Gates and Chang Jun*

Automated Monitoring of Digital Data

— *Eliot Feibush and Tarun Pondicherry*

Electron Beam-based Evaporator for Liquid Metals

— *Richard Majeski*

Enhanced and Expanded MINDS Nuclear Detection Library

— *Charles A. Gentile, Jason Perry, Stephen W. Langish, Kenneth Silber, William M. Davis, and Dana Mastrovita*

Improved Antenna Coil Design for Odd-parity Rotating-magnetic-field Plasma Heating and Current Drive

— *Samuel A. Cohen and Christopher D. Brunkhorst*

Inside Tubing Cutter

— *John DeSandro, John Edwards, Mark Cropper, and Ron Beyer*

Method for In-situ Alignment of and Characterization of the Magnetic Fields Produced by an Array of Coils

— *Michael C. Zarnstorff*

Non-invasive Method to Measure RMF Penetration into High-beta Plasmas

— *Samuel A. Cohen*

Plasma Neutralization Set Up for Ion Beam Compression

— *Igor D. Kaganovich*

Universal Power Meter

— *Steven D. Scott*

Graduate Education

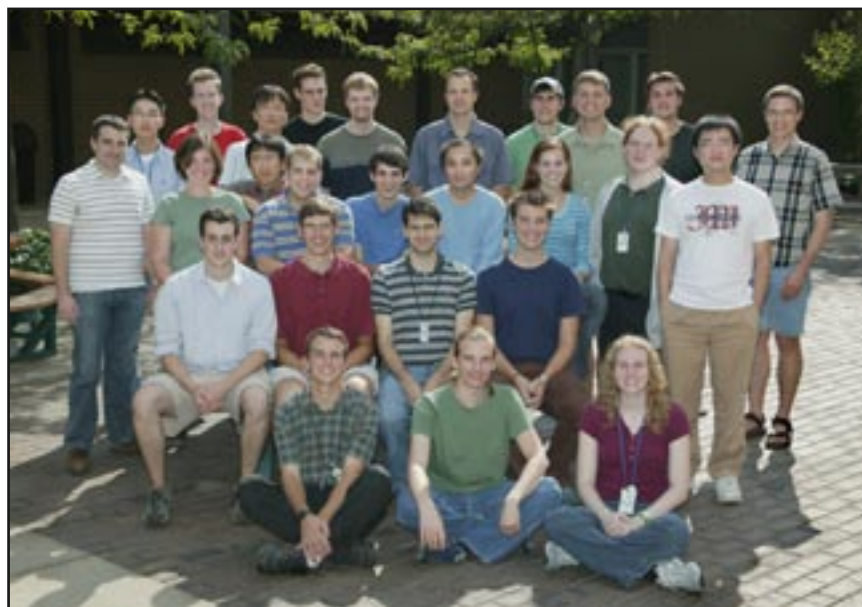

Program in Plasma Physics graduate students for academic year 2005–2006.

Graduate Education at the Princeton Plasma Physics Laboratory is supported through the Program in Plasma Physics and the Program in Plasma Science and Technology. Students in these programs receive advanced degrees from Princeton University. In the Program in Plasma Physics, Doctoral (Ph.D.) degrees are given through the Department of Astrophysical Sciences, while in the Program in Plasma Science and Technology, Masters (M.S.E.) or Doctoral (Ph.D.) degrees are given through the departments of Astrophysical Sciences, Chemical Engineering, Chemistry, Civil Engineering, Computer Science, Electrical Engineering, Mechanical and Aerospace Engineering, and Physics.

Program in Plasma Physics

With more than 230 graduates since 1959, the Program in Plasma Physics has had a significant impact on the field of plasma physics, providing many of today's leaders in the field of plasma research and technology in academic, industrial, and government institutions.

Both basic physics and applications are emphasized in the Program. There are opportunities for research projects in the physics of the very hot plasmas necessary for controlled fusion, as well as for projects in solar, mag-

netospheric and ionospheric physics, plasma processing, plasma thrusters, plasma devices, nonneutral plasmas, lasers, materials research, and in other important and challenging areas of plasma physics.

In FY06, there were 38 graduate students in residence in the Program in Plasma Physics, holding between them one U.S. Department of Energy Magnetic Fusion Energy Science Fellowship, one, U.S. Department of Energy Computational Science Graduate Fellowship, two National Science Fellowships and one Natural Sciences and Engineering Research Council (Canada) fellowship.

Six new students were admitted in FY06 (Table 1), four from the United States and two from Korea. Five students graduated in FY06 (Table 2), accepting positions at The Princeton Plasma Physics Laboratory, General Atomics, University of Alaska at Fairbanks, TriAlpha Energy, Inc., and The University of California at Berkeley.

Program in Plasma Science and Technology

Applications of plasma science and technology meld several traditional scientific and engineering specialties. The Program in Plasma Science and Technology (PPST)

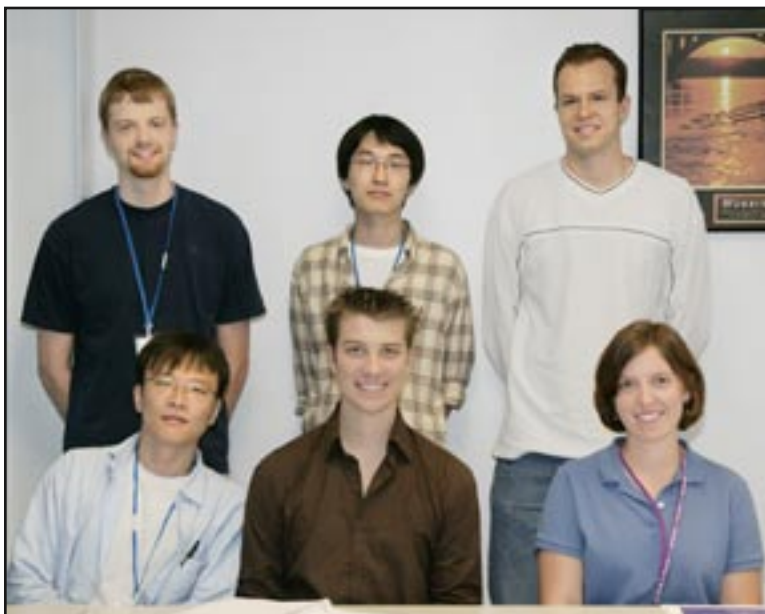

First-year graduate students. Standing (l-r): Craig Jacobson, Eisung Yoon, Erik Granstedt. Seated (l-r): Jongsoo Yoo, Jayson Peterson, Jessica Baumgaertel.

provides strong interdisciplinary support and training for graduate students working in these areas. The scope of interest includes fundamental studies of plasmas, plasma interaction with surfaces and surroundings, and the technologies associated with plasma applications.

Plasmas are essential to many high-technology applications, such as gaseous lasers, in which the lasing medium is plasma. X-ray laser research is prominent in the PPST. Another example is fusion energy for which the fuel is a high-temperature plasma. Lower-temperature plasmas are used for a growing number of materials fabrication processes including the etching of complex patterns for micro- and macro-electronic and optical components and the deposition of tribological, magnetic, optical, conducting, insulating, polymeric, and catalytic thin-films. Plasmas are also important for illumination, microwave generation, destruction of toxic wastes, chemical synthesis, space propulsion, control system theory and experiment, and advanced-design particle accelerators.

The PPST provides support for M.S.E. and Ph.D. students who concentrate on a specific research topic within the field of plasma science and technology while acquiring a broad background in relevant engineering and scientific areas. In FY06, 12 graduate students received support from the PPST during the academic year and/or summer. They co-authored more than twenty refereed publications. Three of the students received Ph.D. degrees from their respective departments.

Professor Sigurd Wagner was the distinguished speaker at the PPST public lecture series held to inform the Princeton community of contributions made by plasma science and technology to our society. In a talk, entitled “Large Area Electronics,” Dr. Wagner, associate of the Liechtenstein Institute on Self-Determination, a senior fellow of the Humboldt Foundation at the University of Constance, Germany, a Corresponding Member of the Austrian Academy of Sciences, and Professor, Department of Electrical Engineering, Princeton University, described flexible large area electronics, the fastest-growing electronic industry today. They are epitomized by flat-panel displays, which have moved from laptop to desktop to TV, and include medical X-ray sensor arrays and thin-film solar cells. The tremendous commercial success of flexible large area electronics has encouraged research on very advanced concepts for conformally shaped and elastically stretchable electronic surfaces and human-sized integrated circuits that can be given any shape: surround displays, solar-cell car roofs, electronic textiles, and touch-sensitive skin.

To enhance a strong graduate program, increased efforts were made to develop appreciation for plasma physics in Princeton undergraduates. Through a summer internship program, nine Princeton undergraduates worked with PPST faculty on plasma physics projects such as plasma thrusters, plasma modification of materials, and the manipulation of chemical reactions by laser light.

Table 1. Students Admitted to the Plasma Physics Program in Fiscal Year 2006

<u>Student</u>	<u>Undergraduate Institution</u>	<u>Major Field</u>
Jessica Baumgaertel	University of Washington	Physics
Erik Granstedt	Caltech	Physics
Craig Jacobson	University of Wisconsin-Madison	Physics
Jayson D.L. Peterson	Vassar College	Physics
Jongsoo Yoo	Pohang University of Science & Technology	Physics
Eisung Yoon	Seoul National University	Physics

Table 2. Recipients of Doctoral Degrees in Fiscal Year 2006.

Kolesnikov, Roman	
Thesis:	Bifurcation Theory of the Transition to Collisionless Ion-temperature-gradient-driven Plasma Turbulence
Advisor:	John A. Krommes
Employer:	Princeton Plasma Physics Laboratory
Belli, Emily	
Thesis:	Studies of Numerical Algorithms for Gyrokinetics and the Effects of Shaping on Plasma Turbulence
Advisor:	Gregory W. Hammett
Employer:	General Atomics
Spaleta, Jeffrey	
Thesis:	Experimental Study of the Effects of Lithium-coated Plasma-facing Components on Energy Confinement Time in the CDX-U Device
Advisors:	Richard Majeski, Cynthia K. Phillips
Employer:	University of Alaska, Fairbanks
Smirnov, Artem	
Thesis:	Experimental and Theoretical Studies of Cylindrical Hall Thrusters
Advisor:	Nathaniel J. Fisch
Employer:	TriAlpha Energy, Inc.
Sharma, Prateek	
Thesis:	Kinetic Effects on Turbulence Driven by the Magnetorotational Instability in Black Hole Accretion
Advisor:	Gregory W. Hammett
Employer:	University of California, Berkeley

Science Education

The goal of the Science Education Program (SEP) at the Princeton Plasma Physics Laboratory (PPPL) is to combine the core research activities of PPPL with science education programs to create a center of excellence for students and teachers. To achieve its goals, the SEP strives to: (1) contribute to the training of the next generation of scientists and engineers, (2) collaborate with K–12 teachers on ways to improve science teaching using an inquiry-based approach to learning, and (3) improve the scientific literacy of the community at large. These initiatives, led by SEP staff in conjunction with PPPL volunteers, master teachers, and local education experts, create significant learning opportunities for undergraduate college students and K–12 teachers and students.

The center of all SEP activities is the Plasma Science Education Laboratory (PSEL), a 3,000-sq.-ft. unique space dedicated to professional development workshops for K–12 teachers, enrichment programs for students,

and high-quality plasma physics research. A fusion of research between education and plasma science, the facility includes a teaching laboratory/classroom, two research labs, and student offices/storage/prep room.

The research performed in the PSEL is centered upon dusty plasmas and plasma processing and is primarily student-centered. Undergraduate and advanced high school students plan all work, formulate research goals, assemble all apparatus, collaborate with scientists and engineers, critique and evaluate each other's work, write papers, and make oral and poster presentations. Simultaneously, the PSEL's open layout for educational workshops fosters communication between participants, master teachers, and student researchers to create a unique learning environment for teachers and students of all abilities.

In FY06, PPPL's Russell Hulse and SEP Head Andrew Zwicker were among 75 chosen by the American Association of Physics Teachers (AAPT) as "notable people



The newly completed Plasma Science Education Laboratory: Clockwise from the upper left is the Dusty Plasma Laboratory, the Plasma Processing Laboratory, the teaching laboratory, and the student office.

in physics and physics education.” They and the other honorees are featured in the organization’s “Celebrating 75 Years of Excellence” publication, produced to observe AAPT’s recent 75 anniversary.

Also in FY06, Elle Starkman, PPPL’s staff photographer, and Andrew Zwicker, collaborated to create “Jump Start,” a digital image chosen for the 2006 Princeton University Art of Science Exhibition. This year’s competition added video submissions for the first time and Andrew Zwicker along with student research interns Emily Margolis, Everett Schlawin, and Will Gannett created “Organized Dust” which was one of five videos accepted for the exhibition.

James Morgan, SEP Program Administrator, continued his study of what attracts students to science and engineering with two papers, “Teaching Information Evaluation and Critical Thinking Skills in the Physics Classroom” with Princeton University Librarian Adriana Popescu, to be published in *The Physics Teacher*, 2007” and “Attracting Millennials to the Sciences and Engineering,” with Professor Beverly Davis, Purdue University presented at the American Association of Engineering Education Meeting, 2006.

Undergraduate Research Programs

PPPL staff continued the tradition of training the next generation of scientists and engineers as 28 stu-

dents participated in PPPL’s undergraduate research programs during FY06. Twenty students from the National Undergraduate Fellowship (NUF) program and eight students from the Science Undergraduate Laboratory Internship (SULI) program completed their summer research at PPPL, other U.S. Department of Energy (DOE) Laboratories, and universities including: General Atomics, Los Alamos National Laboratory, University of California at Irvine, University of Colorado-Boulder, and the Massachusetts Institute of Technology (MIT). The 10-week summer research experience includes a one-week introductory course in plasma physics held at PPPL. Princeton Plasma Physics Laboratory senior researchers, Princeton University faculty, and professors from other institutions teach the course. Professor Nathaniel Fisch, Director of Princeton University’s graduate Program in Plasma Physics, who serves as the program’s Academic Director, leads it.

Three NUF students were scheduled to be recognized for their research at the 2006 American Physical Society’s Division of Plasma Physics meeting. Manuel P. Aldan of Rensselaer Polytechnic Institute (RPI) performed research at General Atomics, Jon Hillesheim of the University of Wisconsin did his research at PPPL, and Paul Schmit of Arizona State University did his work at MIT.



“Jump Start” from the 2006 Princeton University Art of Science competition by Elle Starkman and Andrew Zwicker. In the image, a pile of silica microspheres sits on a table and waits for the right combination of elements it needs to form a particle cloud suspended in plasma, which will float above the table as long as the plasma is maintained.

In September 2006, six former NUF participants entered a Ph.D. program in plasma physics. These students consisted of two females and four males. They are attending Stanford University, the University of California at Berkeley, the University of Texas, the University of California at San Diego (2), and Princeton University.

The NUF program has a proven record of attracting outstanding students to plasma physics Ph.D. programs at rates significantly higher than the national average. We recently completed a ten-year longitudinal study of career choices after past NUF participants completed the internship. We concentrated on students that were Fellows from 1996 – 2005 and for whom we have complete records. For this period, we tracked 114 of 189 students (60%). According to the most recent statistics from the American Institute of Physics:

- From 1987–2003 approximately 35% of all undergraduate physics majors went on to a graduate program in physics.
- In 2001, plasma physics Ph.D. students are approximately 2% of the total number of physics graduate students.
- In 2004, 16% of all graduate students were female.

Compared to students that completed the NUF program:

- 64% of all NUF participants go on to a graduate program in physics, math, or engineering.
- 22% of those enter graduate school to obtain a plasma physics Ph.D.
- From 2002–2005, 30% of all NUF students that entered a plasma physics graduate program were female.

Pre-college Activities

Each year, opportunities exist for motivated high school students to perform independent laboratory work in plasma physics. This year, talented students from the Princeton area worked on a variety of research topics. They include:

Alan Chin: *Graphical User Interface (GUI) Programs for Simulation Codes* (now a member of the Princeton University Class of 2010)

Michael Kennelly: *Laboratory Tests of Magnetorotational Instability in a Plasma*

Sarah Lichtblau: *Characterization and Optimization of Components for Electro-optically Tunable Birefringent*

Filters (Special award at the American Physical Society Division of Plasma Physics Meeting for research done by a high school student)

Emily Margolis: *Troubleshooting the Dusty Plasma Experiment* (now a member of the Princeton University Class of 2010)

Marc Osherson: *Internal Pressure Measurements in Princeton Magnetorotational Instability Experiment* (now a member of the Princeton University Class of 2010)

Tarun Pondicherry: *ELVIS Developments for Simulation and Analysis Programs* (Invention Disclosure Co-author)

Christopher Rossi: *Preliminary Analysis of Coherent Modes in NSTX using the Motional Stark Effect (MSE) Diagnostic*

Michael Zhao: *Improving an Algorithm for Determining Plasma Boundaries* (now a member of the Princeton University Class of 2010)

Science Bowls

High School Science Bowl. On Saturday, February 25, 2006, PPPL hosted 32 teams, from 22 schools, from across the state. More than 40 volunteers from PPPL, Princeton University, Merck, Sarnoff Corp., Bristol-Myers Squibb, and local school districts helped facilitate the competition. East Brunswick High School won, Bergen County Academies placed second, Millburn High School placed third, and fourth place went to West Windsor-Plainsboro North. Teams that did not advance to the later rounds were given a tour of the facility. The first place team also won an all-expense paid trip to Washington, D.C. in early May, where they competed against 72 teams from around the country in the National Science Bowl®. The New Jersey team placed in the top 16 teams overall, for the third year in a row.

Trenton Middle School Science Bowl. PPPL sponsors a middle school Science Bowl for Trenton and other “special needs” school districts. Seven teams of five students each participated in an academic competition and a hydrogen fuel cell car challenge. Overall winners were the Joyce Kilmer eight-graders on the strength of their first place finish in the car race and their second place finish in the academic competition. The winning team received an all-expense paid trip to The University of Denver for the National Competition.

Plasma Camp

Since 1998, the Plasma Science and Fusion Energy Institute (“Plasma Camp”) has brought secondary school teachers from around the country to PPPL for an intensive workshop of plasma physics, fusion energy,



Winners of The Middle School Science Bowl, Joyce Kilmer 8th grade team.

and curriculum writing. Plasmas are ideal to illustrate many concepts in physics and physical science curricula including light, waves, atoms, nuclear reactions, relativity, electricity, and magnetism. An integral part of the Institute is the development of new plasma-based lesson plans, student-led investigations, and demonstrations.

The goals of Plasma Camp are: increase knowledge of plasma physics and fusion energy among secondary school teachers; develop new plasma-based curricula, laboratories, and demonstrations; develop an awareness of the richness and complexity of plasmas through experimentation and exploration of their basic properties; understand some of the social and technological issues addressed by the use of plasma; understand some of the possibilities and constraints in the development of fusion energy; create a network for collaboration and discussion between participants after the conclusion of the Institute and; enhance awareness of the physics of plasmas and fusion within the physics-education community.

In FY06, six teachers from around the country came to PPPL for the workshop. States represented included New Jersey, Florida, Michigan, Texas, and Washington. This year, all participants were new to the program. In addition, based upon the successful results of the 2005 pilot study, an eighth grade teacher and a high school physics teacher from the same district (Trenton Public Schools) participated. They were asked to both develop new curricula for their own classrooms and to develop a joint curriculum on energy that bridges the gap between middle and high school physical science/conceptual physics curricula. Plasma Camp co-creators Andrew Zwicker and Master Teacher Nick Guilbert led the workshop.

Plasma Academy

Each year since 2003, approximately 25 students from the Bergen Academy High School for Math, Science and Technology in Hackensack, NJ spend a week in August at PPPL to participate in an intensive, hands-on workshop, "Energy in the 21st Century: Fusion, Solar, Hydrogen Fuel Cells." The agenda includes laboratory work, lecture, and a tour of PPPL.

The Lewis School Collaboration

The Lewis School of Princeton and PPPL have a unique collaboration intended to combine the science of learning and the learning of science to the benefit of students with learning differences and with the long-range goal of attracting new creative talent to basic science. The partnership extends the opportunity for high quality science education to a population of students that is often overlooked by the general education system.

Currently, The Lewis School of Princeton does not have any science laboratory facilities in the building and at the present time does not have any room for installing such facilities. This dramatically limits the opportunities for experimentation and hands-on learning experiences that the school can provide for the students. Thus, students are brought to the Plasma Science Education Laboratory at PPPL during the school year for a series of laboratories centered upon energy. In FY06 every Lewis School student visited PPPL for a single-day of hands-on scientific inquiry. In addition, a new middle school level energy lab was developed and implemented. Fifteen middle school students worked at PPPL weekly over the course of six weeks.



Plasma Camp teachers developing new curricula to bring back to their classroom.

Science on Saturday

Now in its 22nd year, Science on Saturday has expanded to winter lectures series geared toward high school students, but open to everyone. Scientists and other professionals who are leaders in their respected fields give the talks. The program currently draws more than 350 students, teachers, parents, and community members each Saturday. This year 2,820 people attended the eight-week series — which was a record. The FY06 lectures included:

D is for Digital and Why it Matters — Professor Brian Kernighan, Department of Computer Sciences, Princeton University, Princeton, NJ

The Science Behind Forensics — Dr. Thomas Brettel, Director and Chief Scientist, Office of Forensic Sciences, New Jersey State Police, NJ

How will Tomorrow's Machines be Engineered: Inventing Tools to Design Molecular Devices — Professor Karl Sohlberg, Associate Professor and DuPont Young Professor, Department of Chemistry, Drexel University, Philadelphia, PA

Life After Death in the Abyss: The Saga of an Undersea Volcanic Eruption — Professor Richard A. Lutz, Director, Center for Deep-Sea Ecology and Biotechnology and Professor, Department of Marine and Coastal Sciences, Rutgers University, New Brunswick, NJ

Advances in Coastal Ocean Observation Technologies — Professor Michael S. Bruno, Director, Center for Maritime Systems, Professor of Ocean Engineering, Davidson Laboratory, Stevens Institute of Technology, Hoboken, NJ

The Evolution of Species: Insights from Fish, Chimpanzees and Humans — Professor Jody Hey, Department of Genetics, Rutgers University, New Brunswick, NJ

Synthetic Biology: From Bacteria to Stem Cells — Professor Ronald Weiss, Department of Electrical Engineering, Princeton University, Princeton, NJ

If Archimedes had a Computer: Why Ships, Icebergs, and Buildings Topple — Professor Chris Rorres, School of Veterinary Medicine, University of Pennsylvania, Kennett Square, PA

Scientist-in-Residence Program

The Scientist-in-Residence program brings a PPPL scientist into an elementary school for an extended period of time. Working with teachers and administrators, we create a program tailored to the specific needs of the school that adheres to the New Jersey State Science Standards. In FY06, we worked with the Princeton Junior School to create a month-long exploration of solar energy.

Classroom Visits

In FY06, PPPL staff made 80 K–12 classroom visits to more than 3,100 students and presented at five different science fairs to more than 1,200 students. Both the research and engineering staff participated and made one-hour presentations on energy, fusion, plasmas, and cryogenics.



Students from the Bergen Academy for the Advancement of Science and Technology finding out which team's solar-powered car can climb the steepest hill during the Plasma Academy workshop.

Awards and Honors

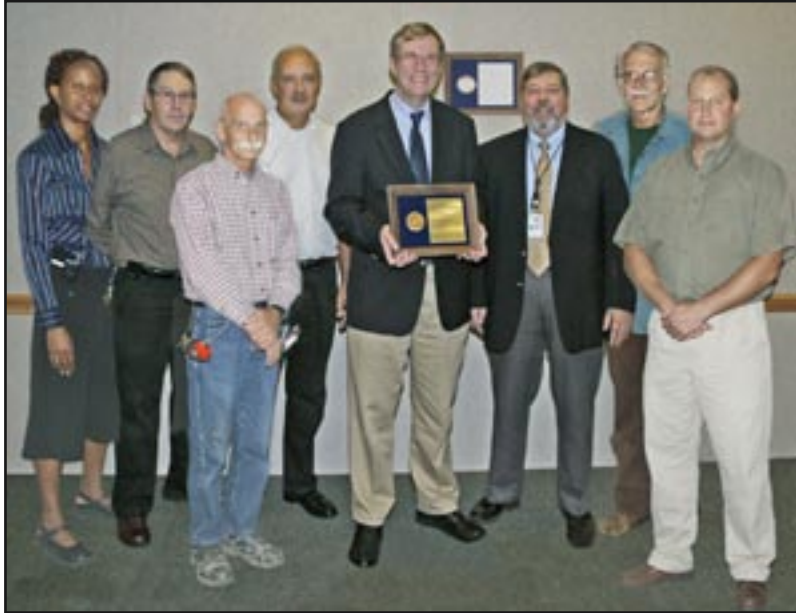

At the presentation of the Pollution Prevention and Environmental Stewardship Accomplishment Award are, from left, PPPL's Margaret Kevin-King, Thomas McGeachen, Joe Franchino, and Charles Kircher with PPPL Deputy Director Rich Hawryluk (holding plaque), DOE Princeton Site Office Manager Jerry Faul, PPPL's Craig Salmon, and PPPL's Keith Rule. The U.S. Department of Energy gave the Laboratory's Maintenance and Operations, and Materiel and Environmental Services staffs the award in recognition of "outstanding commitment to pollution prevention and environmental stewardship through the use of bio-based products in hydraulic systems and cleaning products."

Individual Honors

Elena Belova

Katherine E. Weimer Award for Women in Plasma Physics
American Physical Society-Division of Plasma Physics

Seth Dorfman

Thomas H. Stix '54 Plasma Physics Prize
Princeton University

Nathaniel Fisch

James Clerk Maxwell Prize for Plasma Physics
American Physical Society

Taik Soo Hahm
Kaul Prize for Excellence
in Plasma Physics Research and Technology Development
Princeton University

Ian Parrish
First Place
Computational Science Graduate Fellowship Annual Essay Contest
U.S. Department of Energy

Cynthia Phillips
Fellow
American Physical Society

Wayne Reiersen
PPPL Distinguished Engineering Fellow
Princeton Plasma Physics Laboratory

Prateek Sharma
Ray Grimm Memorial Prize in Computational Physics
Princeton University

William Tang
Distinguished Achievement Award
Chinese Institute of Engineers-USA

Laboratory Honors

Pollution Prevention and Environmental Stewardship Accomplishment Award
U.S. Department of Energy

The Year in Pictures



“Fusion research is long term, scientifically challenging, and critical to the nation and the world,” PPPL Director Rob Goldston told staff in the MBG Auditorium during his State-of-the-Lab address on November 22. He showed the audience a sextant — used for finding latitude — while comparing fusion research with solving the much more difficult problem of finding longitude at sea.

The first modular coil winding form for the National Compact Stellarator Experiment (NCSX) arrived at PPPL on October 3 — a major achievement for the project. Energy Industries of Ohio manufactured the three-ton component.



Upon delivery, the Laboratory’s coil team began constructing the first NCSX modular coil. PPPL’s Mike Anderson installed modular coil parts on the winding form.

A new high-speed computer cluster, “Kite,” was installed during the fall at the Laboratory’s Fusion Computational Center. The system tests computational codes by staff from the Laboratory’s Theory Department and the National Spherical Torus Experiment (NSTX), as well as by collaborators. From left are Kevin Ying, Dan Perry, and Paul Henderson next to the cluster. The team set up the system, installation, and administration.





PPPL's Science-on-Saturday talks drew record crowds in 2006, attracting an average of 380 at each of the eight lectures. Attendance for the wintertime series was up by 12 percent over the previous year. As part of the series, Rutgers University Genetics Professor Jody Hey delivered a talk, "The Evolution of Species: Insights from Fish, Chimpanzees and Humans."



During a visit to PPPL on April 25, DOE Office of Science Director Ray Orbach addressed PPPL staff at an "all hands" meeting and toured the National Compact Stellarator Experiment Coil Winding Facility. During the meeting for employees in the MBG Auditorium, Orbach discussed the American Competitiveness Initiative and the Advanced Energy Initiative, in which fusion plays a role.



On April 29, PPPL participated in Commu-niversity, a town-gown community arts festival in downtown Princeton that drew several thousand people. PPPL physicist Robert Budny discussed fusion with folks who stopped by the PPPL exhibit.



On May 9, the first of three vacuum vessel parts for the National Compact Stellarator Experiment (NCSX) rolled into PPPL. Covered with a protective cloth, the metal hunk — weighing more than 6,000 pounds and filled with holes that made it resemble a silvery twist of Swiss cheese — arrived on a flatbed. By the end of the summer, the other two vessel segments arrived. Major Tool and Machine, Inc., of Indianapolis, manufactured the segments. During final assembly in the NCSX Test Cell, the three segments will be welded together to make a 25,000-pound chamber that looks like a hollow French cruller with only three twists. The completed vessel will have a total of 84 ports, which will provide access for plasma heating and diagnostic devices.



Keynote speaker Shane Bush of the Idaho National Laboratory presented “Celebrating the Human Side of Safety” at the Lab’s annual Safety Forum on May 15. The forum included presentations about safety practices and performance, as well as breakout sessions to discuss solutions for safety issues. The Lab’s ES&H and Infrastructure Support Department hosted the event.



PPPL staff assisted with a fuel-spill cleanup and re-opening the roadway while responding to a May 18 accident on U.S. Route 1. A tractor-trailer had overturned, closing traffic on both sides of the route. The single-vehicle accident left a trailer with a modular office on its side blocking half the roadway and the tractor — with a ruptured fuel tank — straddling the Jersey barrier. Laboratory personnel from the Engineering Department, Environmental Services, and Materiel Services groups assisted PPPL’s Emergency Services Unit, New Jersey State Police, the Plainsboro Township Police and Fire Departments, and the Middlesex County Hazardous Materials Unit with cleanup and safely moving the office trailer to open the roadway. No one was injured and no other vehicles were affected.



PPPL physicist David Johnson (right) was named the U.S. ITER Diagnostics Team Leader and PPPL engineer Charles Neumeyer (above) became the Task Leader for the Steady State Electric Power Network for the U.S. ITER Project Office.



Trenton sculptor Rein Triefeldt (right), inspired by the fusion research led by PPPL Director Rob Goldston, created a giant pink plasma sculpture for Quark Park in Princeton Borough. The temporary garden featured about 14 art installations that were inspired by the work of scientists. The Goldston-Triefeldt collaboration produced “Stellarator,” which included a resin-coated Styrofoam plasma sculpture inside a stellarator-style cage modeled on the National Compact Stellarator Experiment (NCSX) structure. PPPL provided the frame for the sculpture. Triefeldt (left) and Goldston show the finished art.



During the summer, PPPL Principal Research Physicist Brent Stratton was named the new Head of the Diagnostics Development Division at PPPL. Stratton replaced David Johnson, who became the U.S. ITER Diagnostics Team Leader earlier in the year. Stratton is responsible for the development and implementation of new diagnostics in support of all PPPL experimental activities in fusion facilities at the Laboratory and around the world.

PPPL Financial Summary

(Costs Incurred by Fiscal Year in Thousands of Dollars)

	<u>FY2002</u>	<u>FY2003</u>	<u>FY2004</u>	<u>FY2005</u>	<u>FY2006</u>
Operating Costs					
Fusion Energy Sciences					
NSTX	\$19,894	\$25,604	\$27,203	\$27,944	\$26,588
NCSX	3,608	3,109	621	368	405
Theory and Computation	6,201	6,749	6,993	7,086	7,024
Off-site Research	7,601	9,121	7,656	7,474	7,000
CDX-U/LTX	822	743	865	230	205
MRX/MRX Frontier Science Center	462	673	885	867	882
Heavy Ion Fusion	1,191	1,410	1,307	1,211	1,083
Plasma Science and Technology	1,905	2,139	2,347	2,466	2,466
ITER Preparations	–	705	647	2,606	1,623
ITER*	–	–	–	–	186
Science Education Programs	624	667	685	641	498
TFTR	14,936	717	–	–	–
Waste Management**	2,790	–	–	–	–
Other Fusion	1,028	969	1,408	1,572	1,061
Total Fusion Energy Sciences	\$61,062	\$52,606	\$50,617	\$52,465	\$49,021
Advanced Scientific Computing Research	\$547	\$437	\$231	\$536	\$1,016
High Energy Physics	341	181	354	182	192
Basic Energy Sciences	161	79	–	–	–
Safeguards and Security	1,617	1,623	1,907	1,875	1,708
Science Laboratories Infrastructure	710	679	1,237	420	93
Other DOE	308	87	86	141	263
Total DOE Operating	\$64,746	\$55,692	\$54,432	\$55,619	\$52,293
Work for Others					
Federal Sponsors	\$1,424	\$1,958	\$1,661	\$1,394	\$1,194
Nonfederal Sponsors	130	170	523	598	472
Other DOE Facilities	235	103	51	386	73
TOTAL OPERATING COSTS	\$66,535	\$57,923	\$56,667	\$57,997	\$54,032
Capital Equipment Costs					
NSTX	\$1,995	\$976	\$2,365	\$2,168	\$1,326
NCSX	–	4,796	11,392	16,410	17,296
Off-site Research	2,187	1,817	740	1,291	859
LTX	–	–	75	817	633
ITER*	–	–	–	–	2,214
All Other Fusion	1,000	200	850	439	707
All Other DOE	–	–	68	57	–
TOTAL CAPITAL EQUIPMENT COSTS	\$5,182	\$7,789	\$15,490	\$21,182	\$23,035
Construction Costs					
General Plant Projects - Fusion	\$2,170	\$738	\$1,696	\$2,129	\$2,311
General Plant Projects - S&S	–	49	1,265	237	44
Other DOE Construction	64	28	47	258	83
TOTAL CONSTRUCTION COSTS	\$2,234	\$815	\$3,008	\$2,624	\$2,438
TOTAL PPPL	\$73,951	\$66,527	\$75,165	\$81,803	\$79,505

*ITER funded through the U.S. ITER Project Office at Oak Ridge National Laboratory.

**Waste Management transferred to an indirect-funded activity in FY2003.

PPPL Organization and Staffing

PPPL Organization

Directorate

Robert J. Goldston

Director

Richard J. Hawryluk

Deputy Director

William M. Tang

Chief Scientist

Nathaniel J. Fisch

Associate Director for Academic Affairs

John W. DeLooper

Associate Director for External Affairs

Susan E. Murphy-LaMarche

Head, Human Resources

PPPL Director's Cabinet

Robert J. Goldston

Director

Richard J. Hawryluk

Deputy Director

William M. Tang

Chief Scientist

A.J. Stewart Smith

Chair, Princeton University

Research Board

Departments

National Compact Stellarator Experiment

G. Hutch Neilson, Project Manager

J.F. Lyon, Deputy Project Manager*

Off-site Research

J.R. Wilson, Head

R. Nazikian, Deputy

Plasma Science and Technology

Philip C. Efthimion, Head

National Spherical Torus Experiment

Martin Peng, Program Director*

Masayuki Ono, Project Director

Michael D. Williams, Deputy Proj. Dir.

Theory

J. Manickam, Head

Ronald C. Davidson, Deputy

Experiment

Joel C. Hosea

Engineering and Technical Infrastructure

Michael D. Williams

Business Operations

Edward H. Winkler

Environment, Safety, and Health

and Infrastructure Support

John W. Anderson

** from Oak Ridge National Laboratory,
residing at PPPL.*

PPPL Staffing by Fiscal Year as of September 30, 2006

	<u>FY02</u>	<u>FY03</u>	<u>FY04</u>	<u>FY05</u>	<u>FY06</u>
Faculty	3	3	3	3	3
Physicists	95	94	90	83	80
Engineers	82	77	78	73	76
Technicians	166	157	170	161	170
Administrative	72	73	69	73	75
Office and Clerical Support	18	16	17	14	16
Total	436	420	427	407	420

PPPL Advisory Council

The Princeton Plasma Physics Laboratory Advisory Council advises Princeton University on the plans and priorities of the Laboratory. Members of the Advisory Council are appointed by the Board of Trustees and are chosen from other universities and organizations, and from the Board of Trustees. The Council meets biannually and reports to the University President through the Provost. Members listed below served in fiscal year 2006.

Dr. Norman R. Augustine
Lockheed Martin Corporation

Dr. Jonathan Dorfan
Stanford Linear Accelerator Center

Dr. Edward A. Frieman (Chair)
Scripps Institution of Oceanography

Mr. Robert I. Hanfling

Professor Richard D. Hazeltine
University of Texas at Austin

Professor Thomas R. Jarboe
University of Washington, Seattle

Dr. Steve Koonin
British Petroleum

Dr. William Kruer
Lawrence Livermore National Laboratory

Dr. Ants Leetmaa
NOAA's Geophysical Fluid Dynamics Laboratory

Professor Sir Chris Llewellyn-Smith
*United Kingdom Atomic Energy Agency
Culham Division*

Mr. Bruce Mehlman
*Computer Systems Policy Project
Mehlman Strategies*

Dr. Ed Meserve
Carnegie Institute

Dr. Barrett Ripin
Research Applied

Professor Michael S. Turner
University of Chicago

Professor Friedrich Wagner
Max-Planck-Institut für Plasmaphysik

Professor Ellen G. Zweibel
University of Wisconsin at Madison

Publications

*Ahedo, E., Maqueda, I., Anton, A., Raitses, Y., and Fisch, N.J., “Numerical Simulations of a 2-kW Hall Thruster,” in the *Proceedings of the 42th AIAA/ASME/SAE/ASEE Joint Propulsion Conference and Exhibit* (9-12 July 2006, Sacramento, CA), AIAA 2006: 4655.

*†Alonso, J.A., Zweben, S.J., and 11 more co-authors and the TJ-II Team, “Impact of Different Confinement Regimes on the Two-dimensional Structure of Edge Turbulence,” Special Issue Plasma Phys. Control. Fusion **48**:12B (December 2006) B465-B473; Invited paper at the *33rd European Physical Society Conference on Plasma Physics* (19-23 June 2006, Roma, Italy).

*Austin, M.E., Burrell, K.H., Waltz, R.E., and 15 additional co-authors representing 9 institutions including Nazikian, R. from PPPL, “Core Barrier Formation Near Integer q Surfaces in DIII-D,” Phys. Plasmas **13**:8 (August 2006) Article No. 082502 (8 pages).

*Austin, M.E., Burrell, K.H., Waltz, R.E., and 15 additional co-authors representing 9 institutions including Nazikian, R. from PPPL, “Transport Improvement Near Low Order Rotational q Surfaces in DIII-D,” in the *Proceedings of the 21st Fusion Energy Conference (FEC 2006)*, (16-21 October 2006, Chengdu, People’s Republic of China) paper EX/P3-1. An unedited conference proceedings (IAEA CN-149) is available in electronic format on CD-ROM and in PDF format on the IAEA Physics Section web site at <http://www.naweb.iaea.org/naweb/physics/FEC/FEC2006/html/index.htm> (active as of 19 July 2007).

*†Baity, F.W., Pinsker, R.I., Fredd, E.H., Greenough, N.L., Horton, A.R., and Martin, W.C., “Vulnerability of Feedthroughs Operated at a Low-Impedance Point on DIII-D,” in the *Proceedings of the 21st IEEE/NPSS Symposium on Fusion Engineering 2005* (26-29 September 2005, Knoxville, TN) 4 pp. Available from IEEE on CD-ROM, Digital Object Identifier 10.1109/FUSION.2005.252945 (posted online 4 December 2006).

*Bakhtiari, M., Kramer, G.J., and Whyte, D.G., “Momentum-space Study of the Effect of Bremsstrahlung Radiation on the Energy of Runaway Electrons in Tokamaks,” Phys. Plasmas **12**:12 (December 2005) Article No. 102503 (5 pp).

*Bakhtiari, M., Kramer, G.J., Takechi, M., Tamai, H., Miura, Y., Kusama, Y., and Kamada, Y., “Role of Bremsstrahlung Radiation in Limiting the Energy of Runaway Electrons in Tokamaks,” May Lett. **94** (3 June 2005) 215003.

*Bakhtiari, M., Kramer, G.J., Takechi, M., Tamai, H., Miura, Y., Kusama, Y., and Kamada, Y., “Publisher’s Note: Role of Bremsstrahlung Radiation in Limiting the Energy of Runaway Electrons in Tokamaks [Phys. Rev. Lett. **94**, (3 June 2005) 215003],” Phys. Rev. Lett. **94** (13 June 2005) 239901(E).

*Bardamid, A.F., Belyaeva, A.I., Bondarenko, V.N., Galuza, A.A., Kolesnyk, O.G., Kononov, V.G., Naidenkova, D.I., Ryzhkov, I.V., Shapoval, A.N., Skinner, C.H., Shtan, A.F., Solodovchenko, S.I., Voitsenya, V.S., and Yakimov, K.I., “Behaviour of Mirrors Fabricated from Amorphous Alloy under Impact of Deuterium Plasma Ions,” Phys. Scripta **T123** (17 March 2006) 89–93; presented at the *Fifth International Workshop and Summer School on Plasma Physics* (6-10 June 2005, Kudowa Zdój, Poland).

*†Barnard, J.J., Armijo, J., More, R.M., Friedman, A., Kaganovich, I., Logan, B.G., Marinak, M.M., Penn, G.E., Sefkow, A.B., Santhanam, P., Stoltz, P., Veitser, S., and Wurtele, J.S., “Theory and Simulation of Warm Dense Matter Targets,” Nucl. Instrum. Methods Phys. Res. A: Accelerators, Spectrometers, Detectors and Associated Equipment **577**:1-2 (1 July 2007) 275-283; *Proceedings of the 16th International Symposium on Heavy Ion Inertial Fusion*, HIF06 (9-14 July 2006, Saint-Malo, France).

*First author is from another institution. PPPL co-authors are underlined.

†Paper presented at a conference in fiscal year 2006; published in fiscal year 2007.

§Submitted for publication in fiscal year 2006; published in fiscal year 2007.

Baumgaertel, J.A., Redi, M.H., Budny, R.V., Rewoldt, G., and Dorland, W., “Gyrokinetic Stability Studies of the Microtearing Mode in the National Spherical Torus Experiment H-mode,” Princeton Plasma Physics Laboratory Report PPPL-4119 (October 2005) 20 pp; presented at the *Forty-Seventh Annual Meeting of the APS Division of Plasma Physics* (24–28 October 2005, Denver, Colorado).

*†Beiersdorfer, P., Bitter, M., Roquemore, L., Lepson, J., and Gu, M.F., “Grazing-incidence Spectrometer for Soft X-ray and Extreme Ultraviolet Spectroscopy on the National Spherical Torus Experiment,” *Rev. Sci. Instrum.* **77**:10 (October 2006) 10F306 (5 pp); *Proceedings of the 16th Topical Conference on High-Temperature Plasma Diagnostics* (7-11 May 2006, Williamsburg, VA).

Bell, M.G. for the NSTX Research Team, “New Capabilities and Results for the National Spherical Torus Experiment,” in the *Proceedings of the 33rd European Physical Society Conference on Plasma Physics* (19-23 June 2006, Roma, Italy), edited by F. De Marco and G. Vlad, Contributed Papers Vol. **301** (EPS 2006) P-5.117. The conference proceedings is available on CD-ROM. Papers are available in PDF format at <http://eps2006.frascati.enea.it/papers/start.htm> (active as of 2 July 2007).

Bell, M.G., Bell, R.E., Gates, D.A., Kaye, S.M., Kugel, H., LeBlanc, B.P., Levinton, F.M., Maingi, R., Menard, J.E., Raman, R., Sabbagh, S.A., Stutman, D., and the NSTX Research Team, “New Capabilities and Results for the National Spherical Torus Experiment,” *Nucl. Fusion* **46**:8 (August 2006) S565-S572 (Special Section on Spherical Tokamaks and Torii); Princeton Plasma Physics Laboratory Report PPPL-4157 (April 2006) 20 pp.

†Bell, Ronald E., “Carbon Ion Plume Emission Produced by Charge Exchange with Neutral Beams on NSTX,” *Rev. Sci. Instrum.* **77**:10 (October 2006) Article No 10E902 (4 pp); *Proceedings of the 16th Topical Conference on High-Temperature Plasma Diagnostics* (7-11 May 2006, Williamsburg, VA) and Princeton Plasma Physics Laboratory Report PPPL-4167 (June 2006) 12 pp.

Belli, E.A., “Studies of Numerical Algorithms for Gyrokinetics and the Effects of Shaping on Plasma Turbulence,” Ph.D. Dissertation, Princeton University (April 2006).

Belli, E.A. and Hammett, G.W., “A Numerical Instability in an ADI Algorithm for Gyrokinetics,” *Computer*

Physics Communications **172**:2 (1 November 2005) 119-132; Princeton Plasma Physics Laboratory Report PPPL-4034 (December 2004) 18 pp.

Belova, Elena V.; Davidson, Ronald C.; Ji, Hantao; and Yamada, Masaaki, “Advances in the Numerical Modeling of Field-reversed Configurations,” *Phys. Plasmas* **13**:5 (May 2006) Article No. 056115 (5 pp); Invited paper at the *47th Annual Meeting of the American Physical Society, Division of Plasma Physics* (24-28 October 2005, Denver, CO) and Princeton Plasma Physics Laboratory Report 4150 (February 2006) 20 pp.

Belova, E.V., Davidson, R.C., Ji, H., Yamada, M., Cothran, C.D., Brown, M.R., and Schaffer, M.J., “Numerical Study of the Formation, Ion Spin-up and Nonlinear Stability Properties of Field-reversed Configurations,” *Nucl. Fusion* **46**:1 (January 2006) 162-172.

Belova, E.V., Davidson, R.C., Ji, H., Yamada, M., and Gerhardt, S.P., “Effects of Energetic Beam Ions on Stability Properties of Field Reversed Configuration,” in the *Proceedings of the 21st Fusion Energy Conference (FEC 2006)*, (16-21 October 2006, Chengdu, People’s Republic of China) paper TH/P3-16. An unedited conference proceedings (IAEA CN-149) is available in electronic format on CD-ROM and in PDF format on the IAEA Physics Section web site at <http://www-naweb.iaea.org/napc/physics/FEC/FEC2006/html/index.htm> (active as of 19 July 2007).

*Berk, H.L., Boswell, C.J. Borba, D., and 13 additional co-authors representing 9 institutions including Fredrickson, E.D., Gorelenkov, NN., and Medley, S. from PPPL, “Interpretation of Mode Frequency Sweeping in JET and NSTX,” in the *Proceedings of the 21st Fusion Energy Conference (FEC 2006)*, (16-21 October 2006, Chengdu, People’s Republic of China) paper TH/3-1. An unedited conference proceedings (IAEA CN-149) is available in electronic format on CD-ROM and in PDF format on the IAEA Physics Section web site at <http://www-naweb.iaea.org/napc/physics/FEC/FEC2006/html/index.htm> (active as of 19 July 2007).

*Berry, L.A., Batchelor, D.B., Bonoli, P.T., and 11 additional co-authors representing 6 institutions including Okuda, H., Phillips, C.K., and Valeo, E.J. from PPPL, “Analysis of Ion Cyclotron Heating Issues for ITER,” in the *Proceedings of the 21st Fusion Energy Conference (FEC 2006)*, (16-21 October 2006, Chengdu, People’s Republic of China) paper TH/P6-8. An unedited con-

ference proceedings (IAEA CN-149) is available in electronic format on CD-ROM and in PDF format on the IAEA Physics Section web site at <http://www-naweb.iaea.org/napc/physics/FEC/FEC2006/html/index.htm> (active as of 19 July 2007).

*Bertschinger, G., Goto, M., Marchuk, O., Bitter, M., and the TEXTOR-Team, "Space Resolved Measurements of Plasma Parameters using X-ray Spectroscopy of He-like Argon," in the *Proceedings of the 33rd European Physical Society Conference on Plasma Physics and Controlled Fusion* (19-23 June 2006, Roma, Italy), edited by F. De Marco and G. Vlad, Contributed Papers Vol. **301** (EPS 2006) P-2.153. The conference proceedings is available on CD-ROM. Papers are available in PDF format at <http://eps2006.frascati.enea.it/papers/start.htm> (active as of 2 July 2007).

*Biewer, T.M., Maingi, R., Meyer, H., Bell, R.E., Bush, C., Kaye, S., Kubota, S., LeBlanc, B., Williams, K., Zweben, S., and the NSTX Team, "L-to-H Power Threshold Comparisons between NBI and rf heated Plasmas in the National Spherical Torus Experiment," in the *Proceedings of the 33rd European Physical Society Conference on Plasma Physics* (19-23 June 2006, Roma, Italy), edited by F. De Marco and G. Vlad, Contributed Papers Vol. **301** (EPS 2006) P-5.112. The conference proceedings is available on CD-ROM. Papers are available in PDF format at <http://eps2006.frascati.enea.it/papers/start.htm> (active as of 2 July 2007).

Bitter, M.L., Broennimann, Ch., Eikenberry, E.F., Hill, K.W., Ince-Cushman, A., Lee, S.G., Rice, J., and Scott, S., "Application of PILATUS II Detector Modules for High Resolution X-ray Imaging Crystal Spectrometers on the Alcator C-Mod Tokamak," in the *Proceedings of the IEEE 2006 Nuclear Science Symposium, Medical Imaging Conference and 15th International Room Temperature Semiconductor Detector Workshop* (29 October-4 November 2006, San Diego, CA); proceedings published on CD-ROM.

*Blackman, E.G. and Ji, H., "Laboratory Plasma Dynamos, Astrophysical Dynamos and Magnetic Helicity Evolution," *Monthly Notices of the Royal Astronomical Society* **369**:4 (11 July 2006) 1837-1848.

*Boedo, J.A., Maqueda, R.J., Rudakov, D.E., and 19 additional co-authors representing 10 institutions including Kugel, H., Menard, J., Zweben, S.J., and Roquemore, L.A., from PPPL, "Particle and Energy Transport in the SOL of DIII-D and NSTX," in the *Proceedings of the 21st Fusion Energy Conference (FEC*

2006), (16-21 October 2006, Chengdu, People's Republic of China) paper EX/P4-2. An unedited conference proceedings (IAEA CN-149) is available in electronic format on CD-ROM and in PDF format on the IAEA Physics Section web site at <http://www-naweb.iaea.org/napc/physics/FEC/FEC2006/html/index.htm> (active as of 19 July 2007).

*Bonoli, P.T., Harvey, R.W., Kessel, C., and 14 additional co-authors representing 8 institutions, "Benchmarking of Lower Hybrid Current Drive Codes with Application to ITER-relevant Regimes," in the *Proceedings of the 21st Fusion Energy Conference (FEC 2006)*, (16-21 October 2006, Chengdu, People's Republic of China) paper IT/P1-2. An unedited conference proceedings (IAEA CN-149) is available in electronic format on CD-ROM and in PDF format on the IAEA Physics Section web site at <http://www-naweb.iaea.org/napc/physics/FEC/FEC2006/html/index.htm> (active as of 19 July 2007).

*Borba, D., Nazikian, R., Alper, B., the JET EFDA Contributors \bar{x} , and 22 additional co-authors representing 8 institutions including Budny, R.V., Gorelenkov, N.N., Kramer, G.J., Mazzucato, E., and Solomon, W.M. from PPPL, "Excitation of Alfvén Eigenmodes with sub-Alfvénic Neutral Beam Ions in JET and DIII-D Plasmas," in the *Proceedings of the 21st Fusion Energy Conference (FEC 2006)*, (16-21 October 2006, Chengdu, People's Republic of China) paper PD-1. An unedited conference proceedings (IAEA CN-149) is available in electronic format on CD-ROM and in PDF format on the IAEA Physics Section web site at <http://www-naweb.iaea.org/napc/physics/FEC/FEC2006/html/index.htm> (active as of 19 July 2007).

Breslau, J.A., Park, W., and Jardin, S.C., "Massively Parallel Modeling of the Sawtooth Instability in Tokamaks," *J. Phys., Conf. Ser.* **46**:1 (2006) 97-101; presented at *Scientific Discovery through Advanced Computing, SciDAC2006* (25-29 June 2006, Denver, CO).

*§Brizard, A.J. and Hahm, T.S., "Foundations of Nonlinear Gyrokinetic Theory," *Reviews of Modern Physics* **79**:2 (2 April 2007) 421-468; Princeton Plasma Physics Laboratory Report PPPL-4153 (February 2006) 50 pp.

*Brown, M.R., Cothran, C.D., Fung, J., Chang, M., Horwitz, J., Schaffer, M.J., Leuer, J., and Belova, E.V., "Dipole Trapped Spheromak in a Prolate Flux Conserver," *Phys. Plasmas* **13**:10 (October 2006) Article No. 102503 (7 pp).

Budny, R.V., Kessel, C.E., Kinsey, J.E., and 10 additional co-authors representing 9 institutions, "Transport Physics of Hybrid Scenario Plasmas in the International Multi-Tokamak Database and Implications for ITER," in the *Proceedings of the 21st Fusion Energy Conference (FEC 2006)*, (16-21 October 2006, Chengdu, People's Republic of China) paper IT/P1-5. An unedited conference proceedings (IAEA CN-149) is available in electronic format on CD-ROM and in PDF format on the IAEA Physics Section web site at <http://www-naweb.iaea.org/napc/physics/FEC/FEC2006/html/index.htm> (active as of 19 July 2007).

*Burin, M., Schartman, E., Ji, H., Cutler, R., Heitzenroeder, P., Liu, W., Morris, L., and Raftopolous, S., "Reduction of Ekman Circulation within Taylor-Couette Flow," *Experiments in Fluids* **40**:6 (June 2006) 962-966.

*Bush, C.E., Bell, R., Kubota, S., Maqueda, R., Biewer, T., LeBlanc, B., Lee, K.C., Wilgen, J.; Williams, K., Zweben, S., Andre, R., Boedo, J., Medley, S., Tritz, K., Raman, R., Bitter, M., Fredrickson, E., Gates, D., Kaita, R., Kaye, S., Kugel, H., Maingi, R., Menard, J., Roquemore, L., Soukhanovskii, V., Synakowski, E., Wang, W.X., and the NSTX Team, "Spontaneous Flows and Turbulence in Ohmic H-modes on NSTX," presented at the *11th EU-US Transport Task Force Workshop* (4-7 September 2006, Marseille, France).

*Burrell, K.H., Evans, T.E., Doyle, E.J., and 23 co-authors from 8 institutions including Solomon, W.M. from PPPL, "ELM Suppression in Low Edge Collisionality H-mode Discharges using n=3 Magnetic Perturbations," *Special Issue Plasma Phys. Control. Fusion* **47**:12B (December 2005) B37-B52; invited paper at the *32nd European Physical Society Conference on Plasma Physics* (27 June-1 July 2005, Tarragona, Spain).

*Callen, J.D., Anderson, J.K., Arlen, T.C., and 23 additional co-authors representing 12 institutions including Budny, R.V. and Kaye, S.M. from PPPL, "Experimental Tests of Paleoclassical Transport," in the *Proceedings of the 21st Fusion Energy Conference (FEC 2006)*, (16-21 October 2006, Chengdu, People's Republic of China) paper EX/P3-2. An unedited conference proceedings (IAEA CN-149) is available in electronic format on CD-ROM and in PDF format on the IAEA Physics Section web site at <http://www-naweb.iaea.org/napc/physics/FEC/FEC2006/html/index.htm> (active as of 19 July 2007).

†Camp, R., "Electrical Safety and Arc Flash Protection," in the *Proceedings of the 21st IEEE/NPSS Symposium on Fusion Engineering 2005* (26-29 September 2005, Knoxville, TN) 3 pp. Available from IEEE on CD-ROM, Digital Object Identifier 10.1109/FUSION.2005.252995 (posted online 4 December 2006).

*Casper, T.A., Jayakumar, R.J., Allen, S.L., and 11 additional co-authors representing 5 institutions including Kessel, C.E. from PPPL, "Evidence for Anomalous Effects on the Current Evolution in Tokamak Operating Scenarios," in the *Proceedings of the 21st Fusion Energy Conference (FEC 2006)*, (16-21 October 2006, Chengdu, People's Republic of China) paper EX/P6-4. An unedited conference proceedings (IAEA CN-149) is available in electronic format on CD-ROM and in PDF format on the IAEA Physics Section web site at <http://www-naweb.iaea.org/napc/physics/FEC/FEC2006/html/index.htm> (active as of 19 July 2007).

§Chance, M.S., Turnbull, A.D., and Snyder, P.B., "Calculation of the Vacuum Green's Function Valid even for High Toroidal Mode Number in Tokamaks," *J. Computational Physics* **104**:1 (20 January 2007) 330-348; Princeton Plasma Physics Laboratory Report PPPL-4152 (February 2006) 24 pp.

*Chang, C.S., Ku, S., Adams, M., the CPES Team, and 18 additional co-authors representing 9 institutions including Ethier, S., Hahm, T.S., Lee, W.W., Samtaney, R., and Stotler, D. from PPPL, "Integrated Particle Simulation of Neoclassical and Turbulence Physics in the Tokamak Pedestal/Edge Region using XGC," in the *Proceedings of the 21st Fusion Energy Conference (FEC 2006)*, (16-21 October 2006, Chengdu, People's Republic of China) paper TH/P6-14. An unedited conference proceedings (IAEA CN-149) is available in electronic format on CD-ROM and in PDF format on the IAEA Physics Section web site at <http://www-naweb.iaea.org/napc/physics/FEC/FEC2006/html/index.htm> (active as of 19 July 2007).

Chen, J., Strauss, H.R., Jardin, S.C., Park, W., Sugiyama, L.E., Fu, G., and Breslau, J., "Application of Mass Lumped Higher Order Finite Elements," Princeton Plasma Physics Laboratory Report PPPL-4128 (November 2005) 10 pp.

*Choe, Wonho; Kim, Jayhyum; and Ono, Masayuki, "Solenoid-free Toroidal Plasma Start-up Concepts Utilizing only the Outer Poloidal Field Coils and a Conducting Centre-post," *Nucl. Fusion* **45**:12 (December 2005) 1463-1473.

†Chrzanowski, J.H., Fogarty, P.J., Heitzenroeder, P.J., Meighan, T., Nelson, B., Raftopoulos, S., Williamson, D., “Manufacturing Development of the NCSX Modular coil Windings,” in the *Proceedings of the 21st IEEE/NPSS Symposium on Fusion Engineering 2005* (26-29 September 2005, Knoxville, TN) 4 pp. Available from IEEE on CD-ROM, Digital Object Identifier 10.1109/FUSION.2005.252890 (posted online 4 December 2006).

*Chu, M.S., Brennan, D.P., Chan, V.S., and 9 additional co-authors representing 5 institutions including Nazikian, R. and White, R. from PPPL, “Maintaining the Quasi-Steady State Central Current Density Profile in Hybrid Discharges,” in the *Proceedings of the 21st Fusion Energy Conference (FEC 2006)*, (16-21 October 2006, Chengdu, People’s Republic of China) paper EX/1-5. An unedited conference proceedings (IAEA CN-149) is available in electronic format on CD-ROM and in PDF format on the IAEA Physics Section web site at <http://www-naweb.iaea.org/naweb/physics/FEC/FEC2006/html/index.htm> (active as of 19 July 2007).

Chu, T.K., “A Hypothesis of Inductive Drive to Explain TEXTOR’s Sawtooth Measurements,” *Phys. Plasmas* **13:7** (July 2006) Article No. 072503; Princeton Plasma Physics Laboratory Report PPPL-4173 (June 2006) 28 pp.

§Chung, M., Gilson, E.P., Dorf, M., Davidson, R.C., Efthimion, P.C., and Majeski, R., “Ion Injection Optimization for a Linear Paul Trap to Study Ion Beam Propagation,” *Phys. Rev. ST Accel. Beams* **10:1** (2007) Article No. 014202.

*Classen, I.G.J., Westerhof, E., Domier, C.W., Donn , A.J.H., Jaspers, R.J.E., Luhmann, Jr., N.C., Oosterbeek, J.W., Park, H.K., van de Pol, M.J., Spakman, G.W., and the TEXTOR Team, “2-D ECE Temperature Measurements inside Tearing Modes, Revealing the Suppression Mechanism by ECRH at TEXTOR,” in the *Proceedings of the 33rd European Physical Society Conference on Plasma Physics* (19-23 June 2006, Roma, Italy), edited by F. De Marco and G. Vlad, Contributed Papers Vol. **301** (EPS 2006) P-2.169. The conference proceedings is available on CD-ROM. Papers are available in PDF format at <http://eps2006.frascati.enea.it/papers/start.htm> (active as of 2 July 2007).

*†Coad, J.P., Andrew, P., Erents, S.K., Hole, D.E., Likonen, J., Mayer, M., Pitts, R., Rubel, M., Strachan, J.D., Vainonen-Ahlgren, E., Widdowson, A., and JET-EFDA Contributors, “Erosion and Deposition in

the JET MKII-SRP Divertor,” *J. Nucl. Mater.* **363-365** (15 June 2007) 287–293; *Proceedings of the 17th International Conference on Plasma-surface Interactions* 22-26 May 2006, Hefei, Anhui, China).

Cohen, S.A., Sun, Xuan, Ferraro, N.M., Scime, E.E., Miah, M., Stange, S., Siefert, N., and Boivin, R.F., “On Collisionless Ion and Electron Populations in the Magnetic Nozzle Experiment (MNX),” *IEEE Trans. Plasma Sci.* **34:3**, Part 2 (June 2006) 792-803; presented at the *Workshop on Nonlocal, Collisionless Electron Transport in Plasmas* (2-4 August 2005, Princeton, NJ). Princeton Plasma Physics Laboratory Report PPPL-4143 (January 2006) 18 pp.

*Cohen, R.H., LaBombard, B., LoDestro, L.L., Rognlien, T.D., Ryutov, D.D., Terry, J.L., Umansky, M.V., Xu, X.Q., and Zweben, S., “Fluid Simulations and Theory of Boundary Plasma Fluctuations,” in the *Proceedings of the 21st Fusion Energy Conference (FEC 2006)*, (16-21 October 2006, Chengdu, People’s Republic of China) paper TH/P6-25. An unedited conference proceedings (IAEA CN-149) is available in electronic format on CD-ROM and in PDF format on the IAEA Physics Section web site at <http://www-naweb.iaea.org/naweb/physics/FEC/FEC2006/html/index.htm> (active as of 19 July 2007).

*†Cothran, C.D., Fung, J. Brown, M.R., Schaffer, M.J., and Belova, E., “Spectroscopic Flow and Ion Temperature Studies of a Large s FRC,” *J. Fusion Energy* **26:1-2** (June 2007) 37-41; presented at the *Innovative Confinement Concepts Workshop* (13-16 February 2006, Austin, Texas).

*†Craig, D., Goldston, R., Jarboe, T.R., Nelson, B.A., Sovinec, C.R., Woodruff, S., and Wurden, G., “Chair Summaries from the 2006 Innovative Confinement Concepts (ICC) Workshop,” *J. Fusion Energy* **26:1-2** (June 2007) 3-15; presented at the *Innovative Confinement Concepts Workshop* (13-16 February 2006, Austin, Texas).

*Crocker, N.A., Peebles, W.A., Kubota, S., Fredrickson, E.D., Kaye, S.M., LeBlanc, B.P., and Menard, J.E., “Three-wave Interaction between Fast-ion Modes in the National Spherical Torus Experiment,” *Phys. Rev. Lett.* **97:4** (28 July 2006) Article No. 045002.

Dahlgren, F., Brown, T., Heitzenroeder, P., and Bromberg, L., “ARIES-AT Magnet Systems,” *Fusion Eng. Des.* **80:1-4** (January 2006) 139-160 (ARIES-AT Special Issue, A. Rene Raffray, editor).

†Darrow, Doug; Baeumel, Stefan; Cecil, Ed; Ellis, Bob; Fullard, Keith; Hill, Ken; Horton, Alan; Kiptily, Vasily; Pedrick, Les; Reich, Matthias; and Werner, Andreas, “Initial Results from the Lost Alpha Diagnostics on Joint European Torus,” *Rev. Sci. Instrum* **77**:10 (October 2006) Article No 10E701 (5 pp); *Proceedings of the 16th Topical Conference on High-Temperature Plasma Diagnostics* (7-11 May 2006, Williamsburg, VA).

†§Davidson, Ronald C.; Kaganovich, Igor; Startsev, Edward A.; Qin, Hong; Dorf, Mikhail; Sefkow, Adam; Welch, Dale R.; Rose, David V.; and Lund, Steven M., “Multispecies Weibel Instability for Intense Charged Particle Beam Propagation through Neutralizing Background Plasma,” *Nucl. Instrum. Methods Phys. Res. A: Accelerators, Spectrometers, Detectors and Associated Equipment* **577**:1-2 (1 July 2007) 70-78; *Proceedings of the 16th International Symposium on Heavy Ion Inertial Fusion*, HIF06 (9-14 July 2006, Saint-Malo, France).

Davidson, R.C., Logan, B.G., Barnard, J.J., et al., “U.S. Heavy Ion Beam Research for High Energy Density Physics Applications and Fusion,” *Journal de Physique France* **133** (2006) 731.

Davis, W., Mastrovito, D.M., Bush, C.E., Gates, D.A., Maqueda, R.J., Menard, J.E., Nishino, N., Roney, P.G., Roquemore, A.L., Sabbagh, S., Stratton, B.C., and Zweben, S.J., “Storage and Analysis Techniques for Fast 2D Camera Data on NSTX,” *Fusion Engineering and Design* **81**:15-17 (July 2006) 1975-1979; *Proceedings 5th IAEA Technical Meeting on Control, Data Acquisition, and Remote Participation for Fusion Research* (12-15 July 2005, Budapest, Hungary) edited by V. Schmidt.

DeMeo, A. and Phillips, C.A., editors, “Princeton Plasma Physics Laboratory Highlights for Fiscal Year 2005” (June 2006) 198 pp.

†DePasquale, S. and Greenough, N., “Spectral Analysis and Archival of NSTX Data using a High Speed Digitizer,” in the *Proceedings of the 21st IEEE/NPSS Symposium on Fusion Engineering 2005* (26-29 September 2005, Knoxville, TN) 2 pp. Available from IEEE on CD-ROM, Digital Object Identifier 10.1109/FUSION.2005.252972 (posted online 4 December 2006).

†Diem, S., Taylor, G., Efthimion, P.C., LeBlanc, B.P., Carter, M., Caughman, J., Wilgen, J.B., Harvey, R.W., Preinhaelter, J., and Urban, J., “ $T_e(R,t)$ Measurements using Electron Bernstein Wave Thermal Emission

on NSTX,” *Rev. Sci. Instrum* **77**:10 (October 2006) Article No 10E919 (4 pp); *Proceedings of the 16th Topical Conference on High-Temperature Plasma Diagnostics* (7-11 May 2006, Williamsburg, VA).

*Dimits, A.M., Nevins, W.M., Shumaker, D.D., and 8 additional co-authors representing 8 institutions including Hammitt, G.W. from PPPL, “Gyrokinetic Simulations of ETG and ITG Turbulence,” in the *Proceedings of the 21st Fusion Energy Conference (FEC 2006)*, (16-21 October 2006, Chengdu, People’s Republic of China) paper TH/P2-3. An unedited conference proceedings (IAEA CN-149) is available in electronic format on CD-ROM and in PDF format on the IAEA Physics Section web site at <http://www.naweb.iaea.org/naweb/physics/FEC/FEC2006/html/index.htm> (active as of 19 July 2007).

Dodin, I.Y. and Fisch N.J., “Nonadiabatic Ponderomotive Potentials,” *Phys. Lett. A* **349**:5 (16 January 2006) 356-369; Princeton Plasma Physics Laboratory Report PPPL-4110 (October 2005) 16 pp.

Dodin, I.Y. and Fisch, N.J., “One-way Ponderomotive Barrier in a Uniform Magnetic Field,” *Phys. Rev. E* **72**:4 (5 October 2005) Article No. 046602 (5 pages); Princeton Plasma Physics Laboratory Report PPPL-4051 (February 2005) 3 pp.

Dorf, L., Raitsev, Y., and Fisch, N.J., “Effect of Magnetic Field Profile on the Anode Fall in a Hall-effect Thruster Discharge,” *Phys. Plasmas* **13**:5 (May 2006) Article No. 057104 (9 pages); Invited paper at the *47th Annual Meeting of the American Physical Society, Division of Plasma Physics* (24-28 October 2005, Denver, CO).

†Dorf, L.A., Roquemore, A.L., Wurden, G.A., Ticos, C.M., and Wang, Zhehui, “Imaging System for Hypervelocity Dust Injection Diagnostic on NSTX,” *Rev. Sci. Instrum.* **77**:10 (October 2006) Article No. 10E517 (3 pp); *Proceedings of the 16th Topical Conference on High-Temperature Plasma Diagnostics* (7-11 May 2006, Williamsburg, VA).

Dorf, Mikhail; Davidson, Ronald C., and Startsev, Edward A., “Transverse Compression of an Intense Ion Beam Propagating through an Alternating-gradient Quadrupole Lattice,” *Phys. Rev. ST Accel. Beams* **9**:3 (March 2006) Article No. 034202 (6 pages).

*Douglas, Melissa R. and Davidson, Ronald C., “Foreword: Papers from the 47th Annual Meeting of the APS Division of Plasma Physics, Denver, Colorado,

2005,” *Phys. Plasmas* **13**:5 (May 2005) Article No. 055301 (1 page).

*Doyle, E.J., Garofalo, A.M., Greenfield, C.M., and 23 additional co-authors including Kaye, S.M., Menard, J.E., Bell, R.E., Gates, D.A., LeBlanc, B.P., and Okabayashi, M., from PPPL, “Progress on Advanced Tokamak and Steady-state Scenario Development on DIII-D and NSTX,” Special Issue *Plasma Phys. Control. Fusion* **48**:12B (December 2006) B39-B52; Invited paper at the *33rd European Physical Society Conference on Plasma Physics* (19-23 June 2006, Roma, Italy).

*Dunaevsky, A., Goltsov, A., Greenberg, J., Valeo, E., and Fisch, N.J., “Formation of Laser Plasma Channels in a Stationary Gas,” *Phys. Plasmas* **13**:4 (April 2006) Article No. 043106 (7 pages).

*Dunaevsky, A., Raitses, Y., and Fisch, N.J., “Plasma Acceleration from Radio-frequency Discharge in Dielectric Capillary,” *Appl. Phys. Lett.* **88**:25 (19 June 2006) Article No. 251502 (3 pages).

†Efthimion, Philip C.; Gilson, Erik P.; Davidson, Ronald C.; Grisham, Larry; Logan, B. Grant; Seidl, Peter A.; Waldron, William, and Yu, Simon S., “Ferroelectric Plasma Source for Heavy Ion Beam Charge Neutralization,” *Nucl. Instrum. Methods Phys. Res. A: Accelerators, Spectrometers, Detectors and Associated Equipment* **577**:1-2 (1 July 2007) 203-206; *Proceedings of the 16th International Symposium on Heavy Ion Inertial Fusion*, HIF06 (9-14 July 2006, Saint-Malo, France).

*Engebretson, M.J., Keiling, A., Fornacon, K.-H., Cattell, C.A., Johnson, J.R., Posch, J.L., Quick, S.R., Glassmeier, K.-H., Parks, G.K., and Rème H., “Cluster Observations of Pc 1-2 Waves and Associated Ion Distributions during the October and November 2003 Magnetic Storms,” *Planetary and Space Science* **55**:6 (April 2006) 829-848.

†Feder, R., Ellis, R., Johnson, D., Park, H., and Lee, H.G., “Conceptual Design Studies of the KSTAR Bay-Nm Cassette and Thomson Scattering Optics,” in the *Proceedings of the 21st IEEE/NPSS Symposium on Fusion Engineering 2005* (26-29 September 2005, Knoxville, TN) 4 pp. Available from IEEE on CD-ROM, Digital Object Identifier 10.1109/FUSION.2005.252970 (posted online 4 December 2006).

†Feder, R., Mazzucato, E., Munsat, T., Park, H., Smith, D.R., Ellis, R., Labik, G., and Priniski, C., “Mechanical Design of the NSTX High-k Scattering Diagnostic,”

in the *Proceedings of the 21st IEEE/NPSS Symposium on Fusion Engineering 2005* (26-29 September 2005, Knoxville, TN) 4 pp. Available from IEEE on CD-ROM, Digital Object Identifier 10.1109/FUSION.2005.252971 (posted online 4 December 2006).

Ferraro, N.M. and Jardin, S.C., “Finite Element Implementation of Braginskii’s Gyroviscous Stress with Application to the Gravitational Instability,” *Phys. Plasmas* **13**:9 (September 2006) Article No. 092101 (12 pages); Princeton Plasma Physics Laboratory Report PPPL-4161 (May 2006) 24 pp.

§Fisch, N.J., “Alpha Channeling in Mirror Machines,” *Phys. Rev. Lett.* **97**:22 (1 December 2006) Article No. 225001; Princeton Plasma Physics Laboratory Report PPPL-4123 (October 2005) 4 pp.

†Fisch, Nathaniel, J., “Alpha Channeling in Mirror Machines and in Tokamaks,” *Fusion Sci. Technol.* **51**:2T (February 2007) 1-6; presented at the *Sixth International Conference on Open Magnetic Systems for Plasma Confinement - OS2006* (17-21 July 2006, Tsukuba Science City, Japan).

*Fitzgerald, M., Voitsekhovitch, I., Leggate, H., McCune, D.C., McDonald, D., Pereverzev, G.V., Polevoi, A.R., and JET EFDA Contributors, “Monte-Carlo and Fokker-Planck Simulations of Neutral Beam Injection on the JET Tokamak,” in the *Proceedings of the 33rd European Physical Society Conference on Plasma Physics* (19-23 June 2006, Roma, Italy), edited by F. De Marco and G. Vlad, Contributed Papers Vol. **301** (EPS 2006) P-1.079. The conference proceedings is available on CD-ROM. Papers are available in PDF format at <http://eps2006.frascati.enea.it/papers/start.htm> (active as of 2 July 2007).

Foley, E.L. and Levinton, F.M., “A Collisional-radiative Model including Sublevel Parameters (CRISP) for H-alpha Radiation,” *J. Phys. B* **39**:2 (28 January 2006) 443-454.

Foley, E.L. and Levinton, F.M., “Sensitive Dependence of Hydrogen Balmer-alpha Laser-induced Fluorescence Signal from Hydrogen Neutral Beam on Background Magnetic Field,” *J. Appl. Phys.* **98**:9 (November 2005) Article No. 093101 (9 pages).

Fredrickson, E., Georgiyevskiy, A., Rudakov, V., and Zarnstorff, M.C., “Using E-beam Mapping to Detect Coil Misalignment in NCSX,” Princeton Plasma Physics Laboratory Report PPPL-4117 (October 2005) 6 pp;

presented at the *15th International Stellarator Workshop* (3-7 October 2005, Madrid, Spain).

Fredrickson, E.D., Bell, R.E., Darrow, D.S., Fu, G.Y., Gorelenkov, N.N., LeBlanc, B.P., Medley, S.S., Menard, J.E., Park, H., Roquemore, A.L., Sabbagh, S.A., Stutman, D., Tritz, K., Crocker, N.A., Kubota, S., Peebles, W., Lee, K.C., and Levinton, F.M., “Collective Fast Ion Instability-induced Losses in National Spherical Tokamak Experiment,” *Phys. Plasmas* **13**(5) (May 2006) Article No. 056109 (9 pages); Invited paper at the *47th Annual Meeting of the American Physical Society, Division of Plasma Physics* (24-28 October 2005, Denver, CO). Princeton Plasma Physics Laboratory Report PPPL-4183 (July 2006) 20 pp.

†Fredrickson, E.D., Gorelenkov, N.N., Bell, R.E., Menard, J.E., Roquemore, A.L., Kubota, S., Crocker, N.A., and Peebles, W., “Fast Ion Loss in a ‘sea-of-TAE’” *Nucl. Fusion* **46**:10 (October 2006) S926-S932; presented at *9th IAEA Technical Meeting on Energetic Particles in Magnetic Confinement Systems* (9-11 November 2005, Takayama, Japan). Princeton Plasma Physics Laboratory Report PPPL-4184 (July 2006) 20 pp.

Fredrickson, E.D., Gorelenkov, N., Menard, J., and Heidbrink, W., “Observation of Hole-clump Pair Generation by Global or Compressional Alfvén Eigenmodes,” in the *Proceedings of the 33rd European Physical Society Conference on Plasma Physics* (19–23 June 2006, Roma, Italy), edited by F. De Marco and G. Vlad, Contributed Papers Vol. **301** (EPS 2006) P-5.058. The conference proceedings is available on CD-ROM. Papers are available in PDF format at <http://eps2006.frascati.enea.it/papers/start.htm> (active as of 2 July 2007).

§Fredrickson, E.D., Zarnstorff, M.C., and Lazarus, E.A., “Tearing Mode Stability of Model Plasmas in NCSX,” *Fusion Sci. Technol.* **51**:2 (February 2007) 232-237.

*†Freudenberg, K.D., Goranson, P., and Dahlgren, E., “Cooling Design and Analysis of the QPS Modular Coil Winding Packs,” in the *Proceedings of the 21st IEEE/NPSS Symposium on Fusion Engineering 2005* (26-29 September 2005, Knoxville, TN) 4 pp. Available from IEEE on CD-ROM, Digital Object Identifier 10.1109/FUSION.2005.252894 (posted online 4 December 2006).

Fu, G.Y. and Berk, H.L., “Effects of Pressure Gradient on Existence of Alfvén Cascade Modes in Reversed Shear Tokamak Plasmas,” *Phys. Plasmas* **13**:5 (May 2006)

Article No. 052502 (6 pages); Princeton Plasma Physics Laboratory Report PPPL-4159 (May 2006) 16 pages.

Fu, G.Y., Breslau, J.A., Park, W., Jardin, S.C., and Chen, J., “Nonlinear Simulations of Fishbone Instability and Sawteeth in Tokamaks and Spherical Torus,” in the *Proceedings of the 21st Fusion Energy Conference (FEC 2006)*, (16-21 October 2006, Chengdu, People’s Republic of China) paper EX/7-4Rb. An unedited conference proceedings (IAEA CN-149) is available in electronic format on CD-ROM and in PDF format on the IAEA Physics Section web site at <http://www.naweb.iaea.org/napc/physics/FEC/FEC2006/html/index.htm> (active as of 19 July 2007).

Fu, G.Y., Isaev, M., Ku, L.P., Mikhailov, M., Redi, M.H., Sanchez, R., Subbotin, A., Cooper, W.A., Hirshman, S.P., Monticello, D.A., Reiman, A., and Zarnstorff, M., “Ideal Magnetohydrodynamic Stability of the NCSX,” *Fusion Sci. Technol.* **51**:2 (February 2007) 218-231.

Fu, G.Y., Park, W., Strauss, H.R., Breslau, J., Chen, J., Jardin, S., and Sugiyama, L.E., “Global Hybrid Simulations of Energetic Particle Effects on the n=1 Mode in Tokamaks: Internal kink and Fishbone Instability,” *Phys. Plasmas* **13**:5 (May 2006) Article No. 052517 (10 pages); Princeton Plasma Physics Laboratory Report PPPL-4095 (August 2005) 26 pp

*Gao, Q.D., Long, Y.X., Budny, R.V., Jiao, Y.M., Ding, X.T., Pan, Y.D., and Indireskumar, K., “Control and Optimization of Current Profile under Dominant Electron Heating in HL-2A,” in the *Proceedings of the 21st Fusion Energy Conference (FEC 2006)*, (16-21 October 2006, Chengdu, People’s Republic of China) paper EX/P1-17. An unedited conference proceedings (IAEA CN-149) is available in electronic format on CD-ROM and in PDF format on the IAEA Physics Section web site at <http://www.naweb.iaea.org/napc/physics/FEC/FEC2006/html/index.htm> (active as of 19 July 2007).

*§Gao, Zhe; Fisch, Nathaniel J.; and Qin, Hong, “Nonlinear Ponderomotive Force by Low Frequency Waves and Nonresonant Current Drive,” *Phys. Plasmas* **13**:11 (November 2006) Article No. 112307 (6 pages).

*Garofalo, A.M., Doyle, E.J., Ferron, J.R., and 22 additional co-authors including Okabayashi, M. and Solomon, W.M. from PPPL, “Access to Sustained High-beta with Internal Transport Barrier and Negative Central Magnetic Shear in DIII-D,” *Phys. Plasmas* **13**:5 (May 2006) Article No. 056110 (10 pages); ; Invited

paper at the *47th Annual Meeting of the American Physical Society, Division of Plasma Physics* (24-28 October 2005, Denver, CO).

*Garofalo, A.M., Jackson, G.L., La Haye, R.J., the DIII-D Team, and 18 additional co-authors representing 7 institutions including Okabayashi, M., Solomon, W.M., and Takahashi, H. from PPPL, "Active Control of Resistive Wall Modes in High Beta, Low Rotation DIII-D Plasmas," in the *Proceedings of the 21st Fusion Energy Conference (FEC 2006)*, (16-21 October 2006, Chengdu, People's Republic of China) paper EX/7-1Ra. An unedited conference proceedings (IAEA CN-149) is available in electronic format on CD-ROM and in PDF format on the IAEA Physics Section web site at <http://www-naweb.iaea.org/napc/physics/FEC/FEC2006/html/index.htm> (active as of 19 July 2007).

Gates, D.A., Ferron, J.R., Bell, M., Gibney, T., Johnson, R., Marsala, R.J., Mastrovito, D., Menard, J.E., Mueller, D., Penaflor, B., Sabbagh, S.A., and Stevenson, T., "Plasma Shape Control on the National Spherical Torus Experiment (NSTX) using Real-time Equilibrium Reconstruction," *Nucl. Fusion* **46**:1 (January 2006) 17-23.

Gates, D.A., Ferron, J.R., Bell, M., Gibney, T., Johnson, R., Marsala, R.J., Mastrovito, D., Menard, J.E., Mueller, D., Neumeyer, C., Penaflor, B., and Stevenson, T., "Status of the Control System on the National Spherical Torus Experiment," *Fusion Eng. Des.* **81**:15-17 (July 2006) 1911-1916; *Proceedings 5th IAEA Technical Meeting on Control, Data Acquisition, and Remote Participation for Fusion Research* (12-15 July 2005, Budapest, Hungary) edited by V. Schmidt.

Gates, D.A. and 99 co-authors representing 20 institutions, "Progress Towards Steady State on NSTX," Special Issue *Nucl. Fusion* **46**:3 (March 2006) S22-S28; presented at the *4th IAEA Technical Meeting on Steady State Operation* (1-5 February 2005, Ahmedabad, India).

Gates, D.A., Maingi, R., Menard, J. and an additional 96 co-authors representing 20 institutions, "Effect of Plasma Shaping on Performance in the National Spherical Torus Experiment," *Phys. Plasmas* **13**:5 (May 2006) Article No. 056122 (7 pages); Invited paper at the *47th Annual Meeting of the American Physical Society, Division of Plasma Physics* (24-28 October 2005, Denver, CO). Princeton Plasma Physics Laboratory Report PPPL-4125 (November 2005) 28 pp.

Gates, D.A., Menard, J., Maingi, R., and 18 additional co-authors representing 7 institutions, "Progress on NSTX

towards a Stable Steady State at Low Aspect Ratio," in the *Proceedings of the 21st Fusion Energy Conference (FEC 2006)*, (16-21 October 2006, Chengdu, People's Republic of China) paper EX/P1-3. An unedited conference proceedings (IAEA CN-149) is available in electronic format on CD-ROM and in PDF format on the IAEA Physics Section web site at <http://www-naweb.iaea.org/napc/physics/FEC/FEC2006/html/index.htm> (active as of 19 July 2007).

§Gerhardt, S.P., Belova, E., Inomoto, M., Yamada, M., Ji, H., Ren, Y., and Kuritsyn, A., "Equilibrium and Stability Studies of Oblate Field-reversed Configurations in the Magnetic Reconnection Experiment," *Phys. Plasmas* **13**:11 (November 2006) Article No. 112508 (18 pages).

Gerhardt, S.P., Inomoto, M., Belova, E.V., Yamada, M., Ji, H., and Ren, Y., "Studies of Free-Boundary Field Reversed Configurations with Improved Stability in the Magnetic Reconnection Experiment," in the *Proceedings of the 21st Fusion Energy Conference (FEC 2006)*, (16-21 October 2006, Chengdu, People's Republic of China) paper IC/P7-13. An unedited conference proceedings (IAEA CN-149) is available in electronic format on CD-ROM and in PDF format on the IAEA Physics Section web site at <http://www-naweb.iaea.org/napc/physics/FEC/FEC2006/html/index.htm> (active as of 19 July 2007).

Gilson, Erik P.; Chung, Moses; Davidson, Ronald C.; Dorf, Mikhail; Efthimion, Philip C.; and Majeski, Richard, "Experimental Simulations of Beam Propagation Over Large Distances in a Compact Linear Paul Trap," *Phys. Plasmas* **13**:5 (May 2006) Article No. 056705 (7 pages); Invited paper at the *47th Annual Meeting of the American Physical Society, Division of Plasma Physics* (24-28 October 2005, Denver, CO).

†Gilson, Erik P.; Chung, Moses; Davidson, Ronald C.; Dorf, Mikhail; Efthimion, Philip C.; Grote, David P.; Majeski, Richard; and Startsev, Edward A., "Conditions for Minimization of Halo Particle Production during Transverse Compression of Intense Ion Charge Bunches in the Paul Trap Simulator Experiment (PTSX)," *Nucl. Instrum. Methods Phys. Res. A: Accelerators, Spectrometers, Detectors and Associated Equipment* **577**:1-2 (1 July 2007) 117-124; *Proceedings of the 16th International Symposium on Heavy Ion Inertial Fusion*, HIF06 (9-14 July 2006, Saint-Malo, France).

*Gobbin, M., Marrelli, L., Martin, P., and White, R.B., "Monte Carlo Modeling of Test Particles Transport

in Helical Reversed Field Pinch Configurations,” in the *Proceedings of the 33rd European Physical Society Conference on Plasma Physics* (19-23 June 2006, Roma, Italy), edited by F. De Marco and G. Vlad, Contributed Papers Vol. **301** (EPS 2006) P-1.188. The conference proceedings is available on CD-ROM. Papers are available in PDF format at <http://eps2006.frascati.enea.it/papers/start.htm> (active as of 2 July 2007).

*Gohil, P., Evans, T.E., Ferron, J.R., and 19 additional co-authors representing 8 institutions including Kessel, C. and Menard, J. from PPPL, “Control of Plasma Profiles in DIII-D Discharges,” Special Issue Plasma Phys. Control. Fusion **48**:5A (May 2006) A45-A454; papers from the *10th IAEA Technical Meeting on H-mode Physics and Transport Barriers* (28-30 September 2005, St. Petersburg, Russia).

Goldston, R.J., Goldenberg, D.H., Goldston, J.S., Grisham, L.R., and Linton, J.D., “Is Fusion Research Worth It?” in the *Proceedings of the 21st Fusion Energy Conference (FEC 2006)*, (16-21 October 2006, Chengdu, People’s Republic of China) paper SE/P2-1. An unedited conference proceedings (IAEA CN-149) is available in electronic format on CD-ROM and in PDF format on the IAEA Physics Section web site at <http://www-naweb.iaea.org/napc/physics/FEC/FEC2006/html/index.htm> (active as of 19 July 2007).

Gorelenkov, N.N. “Double-Gap Alfvén Eigenmodes: Revisiting Eigenmode Interaction with the Alfvén Continuum,” Phys. Rev. Lett. **95** (27 December 2005) Article No. 265003 (4 pages); Princeton Plasma Physics Laboratory Report PPPL-4131 (December 2005) 10 pp.

Gorelenkov, N.N., “Effect of Safety Factor on TAE Stability in ITER,” *13th Meeting of the ITPA Topical Group on Diagnostics* (23-25 October 2006, Chengdu, China).

Gorelenkov, N.N., Cheng, C.Z., Crocker, N.A., Fredrickson, E.D., Heidbrink, W.W., Kubota, S., Phillips, C.K., Peebles, W.A., and Wang, G., “Phase Space Gradient Driven Discrete Compressional Alfvén Eigenmodes in Tokamaks: Simulations and Observations,” in the *Proceedings of the 21st Fusion Energy Conference (FEC 2006)*, (16-21 October 2006, Chengdu, People’s Republic of China) paper TH/P6-1. An unedited conference proceedings (IAEA CN-149) is available in electronic format on CD-ROM and in PDF format on the IAEA Physics Section web site at <http://www-naweb.iaea.org/napc/physics/FEC/FEC2006/html/index.htm> (active as of 19 July 2007).

†Gorelenkov, N.N., Fredrickson, E.D., Heidbrink, W.W., Crocker, N.A., Kubota, S., and Peebles, W.A., “Discrete Compressional Alfvén Eigenmode Spectrum in Tokamaks,” Nucl. Fusion **46**:10 (October 2006) S933-S941; presented at *9th IAEA Technical Meeting on Energetic Particles in Magnetic Confinement Systems* (9-11 November 2005, Takayama, Japan).

Gorelenkov, N.N., Kramer, G.J., and Nazikian, R., “Interpretation of the Finite Pressure Gradient Effects in the Reversed Shear Alfvén Eigenmode Theory,” Plasma Phys. Control. Fusion **48**:8 (August 2006) 1255-1269.

†Gray, T., Kaita, R., Majeski, R., Spaleta, J., and Timberlake, J., “Fast Gas Injection as a Diagnostic Technique for Particle Confinement Time Measurements,” Rev. Sci. Instrum **77**:10 (October 2006) Article No 10E901 (3 pp); *Proceedings of the 16th Topical Conference on High-Temperature Plasma Diagnostics* (7-11 May 2006, Williamsburg, VA). Princeton Plasma Physics Laboratory Report PPPL-4166 (June 2006) 8 pp.

*Greenfield, C.M., Murakami, M., Garofalo, A.M. and 23 additional co-authors representing 7 institutions including Kessel, C.E. and Okabayashi, M. from PPPL, “Progress Toward High Performance Steady-State Operation in DIII-D,” in the *Proceedings of the 21st Fusion Energy Conference (FEC 2006)*, (16-21 October 2006, Chengdu, People’s Republic of China) paper EX/1-2. An unedited conference proceedings (IAEA CN-149) is available in electronic format on CD-ROM and in PDF format on the IAEA Physics Section web site at <http://www-naweb.iaea.org/napc/physics/FEC/FEC2006/html/index.htm> (active as of 19 July 2007).

*Greenwald, M., Andelin, D., Basse, N., and 63 additional co-authors representing 12 institutions and including Bernabei, S., Hosea, J., Mikkelsen, D.R., Phillips, C., Redi, M., Schilling, G., Scott, S., Wilson, J., and Zweben, S. from PPPL, “Overview of the Alcator C-Mod Program,” Special Issue Nucl. Fusion **45**:10 (October 2005) S109-S117 [Overview and Summary Reports based on the 2004 Fusion Energy Conference Contributions (1-6 November 2004, Vilamoura, Portugal)].

†Grisham, L.R., Kwan, J.W., and Westenskow, G., “Halogens for Negative Ion Beams and Ion-ion Plasmas,” Nucl. Instrum. Methods Phys. Res. A: Accelerators, Spectrometers, Detectors and Associated Equipment **577**:1-2 (1 July 2007) 267-274; *Proceedings of the 16th*

International Symposium on Heavy Ion Inertial Fusion, HIF06 (9-14 July 2006, Saint-Malo, France).

Grisham, L.R., Kwan, J.W., Hahto, S.K., Hahto, S.T., Leung, K.N., and Westenskow, G., "Negative Halogen Ions for Fusion Applications (Invited)," *Rev. Sci. Instrum.* **77**:3 (March 2006) Article No. 03A501 (6 pages); *Proceedings of the 11th International Conference on Ion Sources (ICIS05)* (12-16 September 2005, Caen, France). Princeton Plasma Physics Laboratory Report PPPL-4140 (January 2006) 14 pp.

*Grulke, O., Terry, J.L., LaBombard, B., and Zweben, S.J., "Radial Propagation of Eruptive Turbulent Transport Events in the Scrape-off Layer of Alcator C-Mod," in the *Proceedings of the 21st Fusion Energy Conference (FEC 2006)*, (16-21 October 2006, Chengdu, People's Republic of China) paper EX/P4-7. An unedited conference proceedings (IAEA CN-149) is available in electronic format on CD-ROM and in PDF format on the IAEA Physics Section web site at <http://www-naweb.iaea.org/napc/physics/FEC/FEC2006/html/index.htm> (active as of 19 July 2007).

*Grulke, O., Terry, J.L., LaBombard, B., and Zweben, S.J., "Radially Propagating Fluctuation Structures in the Scrape-off Layer of Alcator C-Mod," *Phys. Plasmas* **13**:1 (January 2006) Article No. 012306 (7 pages).

*Grulke, O., Terry, J.L. and Zweben, S.J., "Scaling of Radial Turbulent Structure Velocities in the Tokamak SOL," in the *Proceedings of the 33rd European Physical Society Conference on Plasma Physics* (19-23 June 2006, Roma, Italy), edited by F. De Marco and G. Vlad, Contributed Papers Vol. **301** (EPS 2006) P-5.119. The conference proceedings is available on CD-ROM. Papers are available in PDF format at <http://eps2006.frascati.enea.it/papers/start.htm> (active as of 2 July 2007).

*Gürçan, Ö.D., Diamond, P.H., and Hahm, T.S., "Nonlinear Triad Interactions and the Mechanism of Spreading in Drift-wave Turbulence," *Phys. Rev. Lett.* **97**:2 (14 July 2006) Article No. 024502.

*Gürçan, Ö.D., Diamond, P.H., and Hahm, T.S., "Radial Transport of Fluctuation Energy in a Two-field Model of Drift-wave Turbulence," *Phys. Plasmas* **13**:5 (May 2006) Article No. 052306 (18 pages).

*Hacquín, S., Sharapov, S., Meneses, L., Alper, B., Challis, C., Cupido, L., Fonseca, A., Mazzucato, E., Meigs, A., Nunes, I., Pinches, S., Prat, L., and the JET EFDA Contributors, "New X-mode Reflectometry

Measurements of Alfvén Eigenmodes on JET," in the *Proceedings of the 33rd European Physical Society Conference on Plasma Physics* (19-23 June 2006, Roma, Italy), edited by F. De Marco and G. Vlad, Contributed Papers Vol. **301** (EPS 2006) D-1.005. The conference proceedings is available on CD-ROM. Papers are available in PDF format at <http://eps2006.frascati.enea.it/papers/start.htm> (active as of 2 July 2007).

†Hahm, T.S., Guenter, S., Peeters, A., and Wilson, H., "Summary of the 2nd IAEA TM on the Theory of Plasma Instabilities: Transport, Stability and their Interaction (Trieste, Italy, 2-4 March 2005)," *Nucl. Fusion* **45**:11 (November 2005) 1457-1460.

Hahm, T.S., Wang, W.X., Rewoldt, G., Manickam, J., and Tang, W.M., "Gyrokinetic Studies of Nonlocal Properties of Turbulence-driven and Neoclassical Transport," in the *Proceedings of the 21st Fusion Energy Conference (FEC 2006)*, (16-21 October 2006, Chengdu, People's Republic of China) paper TH/2-6Ra. An unedited conference proceedings (IAEA CN-149) is available in electronic format on CD-ROM and in PDF format on the IAEA Physics Section web site at <http://www-naweb.iaea.org/napc/physics/FEC/FEC2006/html/index.htm> (active as of 19 July 2007).

Hahm, T.S., Wang, W.X., Rewoldt, G., Manickam, J., and Tang, W.M., "Turbulence Spreading through a Transport Barrier," in the *Proceedings of the 33rd European Physical Society Conference on Plasma Physics* (19-23 June 2006, Roma, Italy), edited by F. De Marco and G. Vlad, Contributed Papers Vol. **301** (EPS 2006) P-4.151. The conference proceedings is available on CD-ROM. Papers are available in PDF format at <http://eps2006.frascati.enea.it/papers/start.htm> (active as of 2 July 2007).

*Harvey, R.W., Cary, J.R., Taylor, G., and 26 additional co-authors representing 9 institutions including Diem, S., Efthimion, P.C., Ellis, R.A., Fredd, E., Hosea, J., LeBlanc, B., Phillips, C.K., and Wilson, J.R. from PPPL, "Electron Bernstein Wave Studies: Current Drive; Emission and Absorption with Nonthermal Distributions; Delta-f Particle-in-Cell Simulations," in the *Proceedings of the 21st Fusion Energy Conference (FEC 2006)*, (16-21 October 2006, Chengdu, People's Republic of China) paper TH/P6-11. An unedited conference proceedings (IAEA CN-149) is available in electronic format on CD-ROM and in PDF format on the IAEA Physics Section web site at <http://www-naweb.iaea.org/napc/physics/FEC/FEC2006/html/index.htm> (active as of 19 July 2007).

*†Heidbrink, W.W., Bell, R.E., Luo, Y., and Solomon, W., “A Fast-ion D-alpha Diagnostic for NSTX,” *Rev. Sci. Instrum* **77**:10 (October 2006) Article No 10F120 (4 pp); *Proceedings of the 16th Topical Conference on High-Temperature Plasma Diagnostics* (7-11 May 2006, Williamsburg, VA).

*Heidbrink, W.W., Fredrickson, E.D., Gorelenkov, N.N., Rhodes, T.L., and Van Zeeland, M.A., “Observation of Compressional Alfvén Eigenmodes (CAE) in a Conventional Tokamak,” *Nucl. Fusion* **46**:2 (February 2006) 324-334.

*Heidbrink, W.W., Kramer, G.J., Nazikian, R., Van Zeeland, M.A., Austin, M.E., Berk, H.L., Burrell, K.H., Gorelenkov, N.N., Luo, Y., McKee, G.R., Rhodes, T.L., Wang, G., and the DIII-D Team, “Alfvén Instabilities in DIII-D: Fluctuation Profiles, Thermal-Ion Excitation, and Fast-Ion Transport,” in the *Proceedings of the 21st Fusion Energy Conference (FEC 2006)*, (16-21 October 2006, Chengdu, People’s Republic of China) paper EX/6-3. An unedited conference proceedings (IAEA CN-149) is available in electronic format on CD-ROM and in PDF format on the IAEA Physics Section web site at <http://www-naweb.iaea.org/napc/physics/FEC/FEC2006/html/index.htm> (active as of 19 July 2007).

*Heidbrink, W.W., Ruskov, E., Fredrickson, E.D., Gorelenkov, N., Medley, S.S., Berk, H.L., and Harvey, R.W., “Weak Effect of Ion Cyclotron Acceleration on Rapidly Chirping Beam-driven Instabilities in the National Spherical Torus Experiment,” *Plasma Phys. Control. Fusion* **48**:9 (September 2006) 1347-1372.

†Heitzenroeder, P., Brown, T., Neilson, G., Malinowski, F., Sutton, L., Nelson, B., Williamson, D., Horton, N., Goddard, B., Edwards, J., Bowling, K., and Hatzilias, K., “The Production Phase for the National Compact Stellarator Experiment (NCSX) Modular Coil Winding Forms,” in the *Proceedings of the 21st IEEE/NPSS Symposium on Fusion Engineering 2005* (26-29 September 2005, Knoxville, TN) 6 pp. Available from IEEE on CD-ROM, Digital Object Identifier 10.1109/FUSION.2005.252888 (posted online 4 December 2006); Princeton Plasma Physics Laboratory Report PPPL-4122 (October 2005) 6 pp.

*Hender, T.C., Reimerdes, H., Chu, M.S., the DIII-D Team, the JET EFDA Contributors, and 8 additional co-authors representing 5 institutions including Okabayashi, M. from PPPL, “Prediction of Rotational Stabilisation of Resistive Wall Modes in ITER,” in the *Proceedings of the 21st Fusion Energy Conference*

(*FEC 2006*), (16-21 October 2006, Chengdu, People’s Republic of China) paper EX/P8-18. An unedited conference proceedings (IAEA CN-149) is available in electronic format on CD-ROM and in PDF format on the IAEA Physics Section web site at <http://www-naweb.iaea.org/napc/physics/FEC/FEC2006/html/index.htm> (active as of 19 July 2007).

*Hidalgo, C., Alonso, J.A., Carvalho, P., the TJ-II Team, and 17 additional co-authors representing 6 institutions including Zweben, S. from PPPL, “On the Link between Edge Momentum Redistribution and Turbulence in the TJ-II Stellarator,” in the *Proceedings of the 21st Fusion Energy Conference (FEC 2006)*, (16-21 October 2006, Chengdu, People’s Republic of China) paper EX/P7-2. An unedited conference proceedings (IAEA CN-149) is available in electronic format on CD-ROM and in PDF format on the IAEA Physics Section web site at <http://www-naweb.iaea.org/napc/physics/FEC/FEC2006/html/index.htm> (active as of 19 July 2007).

*Hole, M.J., Dewar, R.L., and Hudson, S.R., “Equilibria and Stability in Partially Relaxed Plasma-Vacuum Systems,” in the *Proceedings of the 21st Fusion Energy Conference (FEC 2006)*, (16-21 October 2006, Chengdu, People’s Republic of China) paper TH/P3-4. An unedited conference proceedings (IAEA CN-149) is available in electronic format on CD-ROM and in PDF format on the IAEA Physics Section web site at <http://www-naweb.iaea.org/napc/physics/FEC/FEC2006/html/index.htm> (active as of 19 July 2007).

*†Houlberg, W.A., Gormezano, C., Artaud, J.F., the ITPA Steady State Operation Topical Group, the ITPA Confinement Database and Modeling Topical Group, and 21 additional co-authors representing 13 institutions including Budny, R.V. and Kessel, C.E. from PPPL, “Integrated Modelling of the Current Profile in Steady-state and Hybrid ITER Scenarios,” *Nucl. Fusion* **45**:11 (November 2005) 1309-1320.

†Hosea, J., Brunkhorst, C., Fredd, E., Goulding, R.H., Greenough, N., Kung, C., Rasmussen, D.A., Swain, D.W., and Wilson, J.R., “RF Sources for the ITER Ion Cyclotron Heating and Current Drive System,” in the *Proceedings of the 21st IEEE/NPSS Symposium on Fusion Engineering 2005* (26-29 September 2005, Knoxville, TN) 4 pp. Available from IEEE on CD-ROM, Digital Object Identifier 10.1109/FUSION.2005.252942 (posted online 4 December 2006); Princeton Plasma Physics Laboratory Report PPPL-4112 (October 2005) 4 pp.

*§Howes, G.G., Cowley, S.C., Dorland, W., Hammett, G.W., Quataert, E., and Schekochihin, A.A., “Astrophysical Gyrokinetics: Basic Equations and Linear Theory,” *Astrophys. J.* **651**:11 (November 2006) 590-614.

*§Hu, Bo; Betti, R.; and Manickam, J., “Kinetic Stability of the Internal Kink Mode in ITER,” *Phys. Plasmas* **13**:11 (November 2006) Article No. 112505 (9 pages).

§Hudson, S.R., “Calculation of Cantori for Hamiltonian Flows,” *Phys. Rev. E* **74**:5 (November 2006) Article No. 056203 (6 pages).

Hudson, S.R., “Derivatives of the Local Ballooning Growth Rate with Respect to Surface Label, Field Line Label, and Ballooning Parameter,” *Phys. Plasmas* **13**:4 (April 2006) Article No. 042511 (5 pages).

Hulse, R., “Preparing K-12 Students for the New Interdisciplinary World of Science,” *Experimental Biology and Medicine* **231**:7 (2006) 1192-1196; Princeton Plasma Physics Laboratory Report PPPL-4148 (February) 10 pp. Presented at the *Association of Anatomy, Cell Biology, Neurobiology Chairpersons Conference* (18-21 January 2006, Aruba).

*Ide, S. and the JT-60 Team (C.Z. Cheng is a member of JT-60 Team), “Overview of JT-60U Progress towards Steady-state Advanced Tokamak,” *Nucl. Fusion*, **45**:10 (October, 2005) S48-S62. [Special Issue: Overview and Summary Reports Based on the 2004 Fusion Energy Conference Contributions (Vilamoura, Portugal, 1-6 November 2004)].

*In, Y., Kim, J.S., Edgell, D.H., and 10 additional co-authors from four institutions including Okabayashi, M. from PPPL, “Model-based Dynamic Resistive Wall Mode Identification and Feedback Control in the DIII-D Tokamak,” *Phys. Plasmas* **13**:6 (June 2006) Article No. 062512 (12 pages).

*Inomoto, Michiaki; Gerhardt, Stefan P.; Yamad, Masaaki; Ji, Hantao; Belova, Elena; Kuritsyn, Aleksey; and Ren, Yan, “Coupling between Global Geometry and the Local Hall Effect Leading to Reconnection-layer Symmetry Breaking,” *Phys. Rev. Letts.* **97**:13 (29 September 2006) Article No. 135002.

*Ishikawa, M., Takechi, M., Shinohara, K., Kusama, Y., Cheng, C.Z., Matsunaga, G., Todo, Y., Gorelenkov, N.N., Kramer, G.J., Nazikian, R., Fukuyama, A., Krasilnikov, V.A., Kashuck, Y., Nishitani, T.; Morioka,

A., Sasao, M., Isobe, M., and JT-60 Team, “Energetic Ion Transport by Abrupt Large-amplitude Event Induced by Negative-ion-based Neutral Beam Injection in the JT-60U,” *Nucl. Fusion* **45**:12 (December 2005) 1474-1480.

*†Ishikawa, M., Takechi, M., Shinohara, K., Kusama, Y., Matsunaga, G., Krasilnikov, V.A., Kashuck, Yu., Isobe, M., Nishitani, T., Morioka, A., Sasao, M., Cheng, C.Z., Gorelenkov, N.N., Kramer, G.J., Nazikian, R., and the JT-60 team, “Observation of Confinement Degradation of Energetic Ions due to Alfvén Eigenmodes in JT-60U Weak Shear Plasmas,” *Nucl. Fusion* **46**:10 (October 2006) S898-S903; presented at *9th IAEA Technical Meeting on Energetic Particles in Magnetic Confinement Systems* (9-11 November 2005, Takayama, Japan).

*†Isobe, M., Toi, K., Matsushita, H., the CHS team, and 18 additional co-authors including D.S. Darrow from PPPL, “Studies of Fast-ion Transport Induced by Energetic Particle Modes using Fast-particle Diagnostics with High Time Resolution in CHS,” *Nucl. Fusion* **46**:10 (October 2006) S918-S925; presented at *9th IAEA Technical Meeting on Energetic Particles in Magnetic Confinement Systems* (9-11 November 2005, Takayama, Japan).

*Itoh, K., Itoh, S.I., Diamond, P.H., Hahm, T.S., Fujisawa, A., Tynan, G.R., Yagi, M., and Nagashima, Y., “Physics of Zonal Flows,” *Phys. Plasmas* **13**:5 (May 2006) Article No. 055502 (11 pages); review paper at the *47th Annual Meeting of the American Physical Society, Division of Plasma Physics* (24-28 October 2005, Denver, CO).

*Jackson, G.L., Bialek, J.M., Driskill, S.A., Garofalo, A.M., In, Y., Katsuro-Hopkins, O., Kellman, A.G., La Haye, R.J., Nagy, A., Navratil, G.A., Okabayashi, M., Reimerdes, H., Scoville, J.T., Strait, E.J., and Takahashi, H., “Experiments and Modeling using Resistive Wall Mode Feedback Control in DIII-D,” in the *Proceedings of the 33rd European Physical Society Conference on Plasma Physics* (19-23 June 2006, Roma, Italy), edited by F. De Marco and G. Vlad, Contributed Papers Vol. **301** (EPS 2006) P-5.143. The conference proceedings is available on CD-ROM. Papers are available in PDF format at <http://eps2006.frascati.enea.it/papers/start.htm> (active as of 2 July 2007).

*Jaeger, E.F., Berry, L.A., Ahern, S.D., Barrett, R.F., Batchelor, D.B., Carter, M.D., D’Azevedo, E.F., Moore, R.D., Harvey, R.W., Myra, J.R., D’Ippolito, D.A., Dumont, R.J., Phillips, C.K., Okuda, H., Smithe,

D.N., Bonoli, P.T., Wright, J.C.; and Choi, M., “Self-Consistent Full-wave and Fokker-Planck Calculations for Ion Cyclotron Heating in Non-Maxwellian Plasmas,” *Phys. Plasmas* **13**:5 (May 2006) Article No. 056101 (9 pages); invited paper at the *47th Annual Meeting of the American Physical Society, Division of Plasma Physics* (24–28 October 2005, Denver, CO).

*Jaeger, E.F., Harvey, R.W., Berry, L.A., Myra, J.R., Dumont, R.J., Phillips, C.K., Smithe, D.N., Barrett, R.F., Batchelor, D.B., Bonoli, P.T., Carter, M.D., D’Azevedo, E.F., D’Ippolito, D.A., Moore, R.D., and Wright, J.C., “Global-wave Solutions with Self-consistent Velocity Distributions in Ion Cyclotron Heated Plasmas,” *Nucl. Fusion* **46**:7 (July 2006) S397-S408 (Special Section on the Physics and Technology of Plasma Heating by ICRF Power).

Jardin, S., Miura, Y., Noterdaeme, J.M.; and Ozeki, T., “Summary of the International Energy Agency Workshop on Burning Plasma Physics and Simulation, July 4-5, 2005,” *Fusion Sci. Technol.* **49**:1 (January 2006) 79-85.

Jardin, S.C., “Integrated Modeling for Burning Plasmas,” Princeton Plasma Physics Laboratory Report PPPL-4124 (October 2005) 6 pp; presented at the *Workshop on Burning Plasma Physics and Simulation* (4-5 July 2005, Tarragona, Spain).

Jardin, S.C., Kessel, C.E., Mau, T.K., Miller, R.L., Najmabadi, F., Chan, V.S., Chu, M.S., LaHaye, R., Lao, L.L., Petrie, T.W., Politzer, P., St John, H.E., Snyder, P., Staebler, G.M., Turnbull, A.D., and West, W.P., “Physics Basis for the Advanced Tokamak Fusion Power Plant, ARIES-AT,” *Fusion Eng. Des.* **80**:1-4 (January 2006) 25-62 (ARIES-AT Special Issue, A. Rene Raffray, editor).

*Jaspers, R.J.E., Hogewei, G.M.D., Park, H.K., the TEXTOR-Team, and 13 additional co-authors representing 4 institutions, “Imaging and Manipulation of Sawteeth and Tearing Modes in TEXTOR,” in the *Proceedings of the 21st Fusion Energy Conference (FEC 2006)*, (16-21 October 2006, Chengdu, People’s Republic of China) paper EX/P8-17. An unedited conference proceedings (IAEA CN-149) is available in electronic format on CD-ROM and in PDF format on the IAEA Physics Section web site at <http://www.naweb.iaea.org/napc/physics/FEC/FEC2006/html/index.htm> (active as of 19 July 2007).

§Jenkins, Thomas G. and Lee, W.W., “Fluctuations and Discrete Particle Noise in Gyrokinetic Simulation of

Drift Waves,” *Phys. Plasmas* **14**:3 (March 2007) Article No. 032307 (10 pages); Princeton Plasma Physics Laboratory Report PPPL-4185 (August 2006) 36 pp.

†Ji, H., Belova, E., Gerhardt, S.P., and Yamada, M., “Recent Advances in the SPIRIT (Self-organized Plasma with Induction, Reconnection, and Injection Techniques) Concept,” *J. Fusion Energy* **26**:1-2 (June 2007) 93-97; presented at the *Innovative Confinement Concepts Workshop* (13-16 February 2006, Austin, Texas).

Ji, H., Burin, M., Schartman, E., and Goodman J., “Hydrodynamic Turbulence Cannot Transport Angular Momentum Effectively in Astrophysical Disks,” *Nature* **444**:7117 (16 November 2006) 343-346.

†Johnson, David; Young, Kenneth M.; Boivin, Rejean; Allen, Steve; Costley, Alan; and Walker, Chris, “The US Role in ITER Diagnostics,” in the *Proceedings of the 21st IEEE/NPSS Symposium on Fusion Engineering 2005* (26-29 September 2005, Knoxville, TN) 6 pp. Available from IEEE on CD-ROM, Digital Object Identifier 10.1109/FUSION.2005.252961 (posted online 4 December 2006).

*†Jun, Chang, H.; Gentile, Charles; Priniski, Craig; and Sethian, John, “Design and Numerical Stress Analysis of Silicon Membrane Hibachi Windows,” in the *Proceedings of the 21st IEEE/NPSS Symposium on Fusion Engineering 2005* (26-29 September 2005, Knoxville, TN) 4 pp. Available from IEEE on CD-ROM, Digital Object Identifier 10.1109/FUSION.2005.252867 (posted online 4 December 2006).

Kaganovich, I., Raitses, Y., and Cohen, S., “Guest Editorial Special Issue of Invited papers of 2005 Workshop on Nonlocal, Collisionless Electron Transport” *IEEE Trans. Plasma Sci.* **34**:3 Part 2 (June 2006) 694-695; presented at the *Workshop on Nonlocal, Collisionless Electron Transport in Plasmas* (2-4 August 2005, Princeton, NJ).

Kaganovich, I.D., Polomarov, O.V., and Theodosiou, C.E., “Revisiting Anomalous RF Field Penetration into a Warm Plasma,” *IEEE Trans. Plasma Sci.* **34**:3 Part 2 (June 2006) 696–717; presented at the *Workshop on Nonlocal, Collisionless Electron Transport in Plasmas* (2-4 August 2005, Princeton, NJ).

†Kaganovich, Igor D.; Sefkow, Adam B.; Startsev, Edward A.; Davidson, Ronald C.; and Welch, Dale R., “Effects of Finite Pulse Length, Magnetic Field, and

Gas Ionization on Ion Beam Pulse Neutralization by Background Plasma,” Nucl. Instrum. Methods Phys. Res. A: Accelerators, Spectrometers, Detectors and Associated Equipment **577**:1-2 (1 July 2007) 93-102; *Proceedings of the 16th International Symposium on Heavy Ion Inertial Fusion*, HIF06 (9-14 July 2006, Saint-Malo, France).

Kaganovich, Igor D.; Startsev, Edward; and Davidson, Ronald C., “Scaling and Formulary of Cross-sections for Ion-atom Impact Ionization,” New J. Phys. **8** (November 2006) 278.

†Kaita, R., Majeski, R., Doerner, R., Gray, T., Kugel, H., Lynch, T., Maingi, R., Mansfield, D., Soukhanovskii, V., Spaleta, J., Timberlake, J., and Zakharov, L., “Extremely Low Recycling and High Power Density Handling in CDX-U Lithium Experiments,” J. Nucl. Mater. **363-365** (15 June 2007) 1231-1235; *Proceedings of the 17th International Conference on Plasma-surface Interactions* 22-26 May 2006, Hefei, Anhui, China).

†Kalish, M., Rushinski, J., Myatt, L., Brooks, A., Dahlgren, F., Chrzanowski, J., Reiersen, W., and Freudenberg, K., “NCSX Toroidal Field Coil Design,” in the *Proceedings of the 21st IEEE/NPSS Symposium on Fusion Engineering 2005* (26-29 September 2005, Knoxville, TN) 4 pp. Available from IEEE on CD-ROM, Digital Object Identifier 10.1109/FUSION.2005.252891 (posted online 4 December 2006); Princeton Plasma Physics Laboratory Report PPPL-4115 (October 2005) 4 pp.

Kaye, S.M., Bell, M.G., Bell, R.E. and an additional 140 co-authors represent 29 institutions, “Progress towards High Performance Plasmas in the National Spherical Torus Experiment (NSTX),” Special Issue Nucl. Fusion **45**:10 (October 2005) S168-S180 [Overview and Summary Reports based on the 2004 Fusion Energy Conference Contributions (1-6 November 2004, Vilamoura, Portugal)]; Princeton Plasma Physics Laboratory Report PPPL-4126 (November 2005) 40 pp.

§Kaye, S.M., Bell, M.G., Bell, R.E., Fredrickson, E.D., LeBlanc, B.P., Lee, K.C., Lynch, S., and Sabbagh, S.A., “Energy Confinement Scaling in the Low Aspect Ratio National Spherical Torus Experiment (NSTX),” Nucl. Fusion **46**:10 (October 2006) 848-857.

Kaye, S.M., Levinton, F.M., Stutman, D., Tritz, K., Yuh, H., Bell, M.G., Bell, R.E., Horton, W., Kim, J., LeBlanc, B.P., Maingi, R., Mazzucato, E., Menard, J.E.,

Mikkelsen, D., Park, H., Rewoldt, G., Sabbagh, S.A., Smith, D.R., and Wang, W., “Confinement and Local Transport in the National Spherical Torus Experiment (NSTX),” in the *Proceedings of the 21st Fusion Energy Conference (FEC2006)*, (16-21 October 2006, Chengdu, People’s Republic of China) paper EX/8-6. An unedited conference proceedings (IAEA CN-149) is available in electronic format on CD-ROM and in PDF format on the IAEA Physics Section web site at <http://www-naweb.iaea.org/naweb/physics/FEC/FEC2006/html/index.htm> (active as of 19 July 2007).

Kaye, S.M., Valovic, M., Chudnovskiy, A., Cordey, J.G., McDonald, D., Meakins, A., Thomsen, K., Akers, R., Bracco, G., Brickley, C., Bush, C., Cote, A., DeBoo, J.C., Greenwald, M., Hoang, G.T., Hogweij, D., Imbeaux, F., Kamada, Y., Kardaun, O.J.W.F., Kus, A., Lebedev, S., Leonov, V., Lynch, S., Martin, Y., Miura, Y., Ongena, J., Pacher, G., Petty, C.C., Romanelli, M., Ryter, F., Shinohara, K., Snipes, J., Stober, J., Takizuka, T., Tsuzuki, K., and Urano, H., “The Role of Aspect Ratio and Beta in H-mode Confinement Scalings,” Special Issue Plasma Phys. Control. Fusion **48**:5A (May 2006) A429-A438; papers from the *10th IAEA Technical Meeting on H-mode Physics and Transport Barriers* (28-30 September 2005, St. Petersburg, Russia). Princeton Plasma Physics Laboratory Report PPPL-4121 (October 2005) 10 pp.

*Keahey, K., Papka, M.E., Peng, Q., Schissel, D., Abl, G., Araki, T., Burruss, J., Feibush, E., Lane, P., Klasky, S., Leggett, T., McCune, D., and Randerson, L., “Grid Support for Collaborative Control Room in Fusion Science Cluster Computing,” Journal of Networks Software Tools and Applications **8**:4 (October 2005) 305-311.

*Keidar, M., Raitses, Y., Knapp, A., and Waas, A.M., “Current-driven Ignition of Single-wall Carbon Nanotubes,” Carbon **44**:5 (April 2006) 1022-1024.

*Keidar, M., Waas, A.M., Raitses, Y., and Waldorf, E.I., “Modeling of Anodic Arc Discharge for Single Wall Nanotube Growth,” Journal of Nanoscience and Nanotechnology **6** (2006) 32.

Kessel, C.E., Bell, R.E., Bell, M.G., Gates, D.A.; Kaye, S.M., LeBlanc, B.P., Menard, J.E., Phillips, C.K.; Synakowski, E.J., Taylor, G., Wilson, R., Harvey, R.W., Mau, T.K., Ryan, P.M., and Sabbagh, S.A., “Long Pulse High Performance Plasma Scenario Development for the National Spherical Torus Experiment,” Phys. Plasmas **13**:5 (May 2006) Article No. 056108 (12 pages); invited

paper at the *47th Annual Meeting of the American Physical Society, Division of Plasma Physics* (24-28 October 2005, Denver, CO). Princeton Plasma Physics Laboratory Report PPPL-4141 (January 2006) 34 pp.

Kessel, C.E., Budny, R.V., Garofalo, A.M., Greenfield, C.M., Murakami, M., Pinsker, R.I., and Ryan, P.M., “Modeling of Fast Wave Heating and Current Drive in DIII-D High Performance Plasmas,” in the *Proceedings of the 33rd European Physical Society Conference on Plasma Physics and Controlled Fusion* (19-23 June 2006, Roma, Italy), edited by F. De Marco and G. Vlad, Contributed Papers Vol. **301** (EPS 2006) P-5.146. The conference proceedings is available on CD-ROM. Papers are available in PDF format at <http://eps2006.frascati.enea.it/papers/start.htm> (active as of 2 July 2007). Princeton Plasma Physics Laboratory Report PPPL-4176 (June 2006) 6 pp.

†Kessel, C.E., Budny, R.V., and Indireskumar, K., “Simulation and Analysis of the Hybrid Operating Mode in ITER,” in the *Proceedings of the 21st IEEE/NPSS Symposium on Fusion Engineering 2005* (26-29 September 2005, Knoxville, TN) 4 pp. Available from IEEE on CD-ROM, Digital Object Identifier 10.1109/FUSION.2005.252943 (posted online 4 December 2006).

Kessel, C.E., Giruzzi, G., Sips, A.C.C., and 17 additional co-authors representing 10 institutions, “Simulation of the Hybrid and Steady State Advanced Operating Modes in ITER,” in the *Proceedings of the 21st Fusion Energy Conference (FEC 2006)*, (16-21 October 2006, Chengdu, People’s Republic of China) paper IT/P1-7. An unedited conference proceedings (IAEA CN-149) is available in electronic format on CD-ROM and in PDF format on the IAEA Physics Section web site at <http://www-naweb.iaea.org/napc/physics/FEC/FEC2006/html/index.htm> (active as of 19 July 2007).

Kessel, C.E., Mau, T.K., Jardin, S.C., and Najmabadi, F., “Plasma Profile and Shape Optimization for the Advanced Tokamak Power Plant, ARIES-AT” *Fusion Eng. Des.* **80**:1-4 (January 2006) 63-77 (ARIES-AT Special Issue, A. Rene Raffray, editor).

*Kiptily, V.G., Cecil, F.E., and Medley, S.S., “Gamma Ray Diagnostics of High Temperature Magnetically Confined Fusion Plasmas,” *Plasma Phys. Control. Fusion* **48**:8 (August 2006) R59-R82.

*Kirschner, A., Philipps, V., Balden, M., the JET-EFDA Contributors, and 18 additional co-authors represent-

ing 9 institutions including Strachan, J.D. from PPPL, “Material Erosion and Redeposition during the JET MkIIIGB-SRP Divertor Campaign,” in the *Proceedings of the 21st Fusion Energy Conference (FEC 2006)*, (16-21 October 2006, Chengdu, People’s Republic of China) paper EX/3-5. An unedited conference proceedings (IAEA CN-149) is available in electronic format on CD-ROM and in PDF format on the IAEA Physics Section web site at <http://www-naweb.iaea.org/napc/physics/FEC/FEC2006/html/index.htm> (active as of 19 July 2007).

*†Kolesnichenko, Ya.I., Lutsenko, V.V., Marchenko, V.S., Weller, A., White, R.B., Yakovenko, Yu.V., and Yamazaki, K., “Magnetohydrodynamic Activity and Energetic Ions in Fusion Plasmas,” *Special Issue Plasma Phys. Control. Fusion* **49**:5A (May 2007) A159-A166; invited papers from the *13th International Congress on Plasma Physics* (22-26 May 2006, Kiev, Ukraine). Princeton Plasma Physics Laboratory Report PPPL-4172 (June 2006) 8 pp.

*Kolesnichenko, Ya.I., Marchenko, V.S., and White, R.B., “Interchange and Infernal Fishbone Modes in Plasmas with Tangentially Injected Beams,” *Phys Plasmas* **13**:5 (May 2006) Article No. 052504 (6 pages); Princeton Plasma Physics Laboratory Report 4139 (January 2006) 18 pp.

*§Kolesnichenko, Ya.I., White, R.B., and Yakovenko, Yu.V., “High-frequency Shear Alfvén Instability Driven by Circulating Energetic Ions in NSTX,” *Phys. Plasmas* **13**:12 (December 2006) Article No. 122503 (3 pages).

Kolesnikov, R., “Bifurcation Theory of the Transition to Collisionless Ion-temperature-gradient-driven Plasma Turbulence,” Ph.D. Dissertation, Princeton University (January 2006).

Kolesnikov, R.A. and Krommes, J.A., “Bifurcation Theory of the Transition to Collisionless ion-temperature-gradient-driven Plasma Turbulence,” *Phys. Plasmas* **12**:12 (December 2005) Article No. 122302 (25 pages); Princeton Plasma Physics Laboratory Report PPPL-4102 (September 2005) 64 pp.

*Kolesnychenko, O.Ya., Lutsenko, V.V., and White, R.B., “Ion Acceleration in Plasmas with Alfvén Waves,” *Phys. Plasmas* **12**:10 (October 2005) Article No. 102101 (8 pages).

*Kotschenreuther, M.T., Valanju, P.M., Mahajan, S.M. and 6 additional co-authors representing 4 insti-

tutions including Gates, D. from PPPL, “On Heat Loading, Divertors and Reactors,” in the *Proceedings of the 21st Fusion Energy Conference (FEC 2006)*, (16-21 October 2006, Chengdu, People’s Republic of China) paper IC/P7-12. An unedited conference proceedings (IAEA CN-149) is available in electronic format on CD-ROM and in PDF format on the IAEA Physics Section web site at <http://www-naweb.iaea.org/napc/physics/FEC/FEC2006/html/index.htm> (active as of 19 July 2007).

Kramer, G.J. and Fu, G.-Y., “Reversed Shear Alfvén Eigenmodes Associated with the Ellipticity and Triangularity Alfvén Gaps,” *Plasma Phys. Control. Fusion* **48:9** (September 2006) 1285-1296; Princeton Plasma Physics Laboratory Report PPPL-4163 (June 2006) 18 pp.

Kramer, G.J., Nazikian, R., Alper, B., de Baar, M., Berk, H.L., Fu, G.-Y., Gorelenkov, N.N., McKee, G., Pinches, S.D., Rhodes, T.L., Sharapov, S.E., Solomon, W.M., van Zeeland, M.A., and JET EFDA Contributors, “Interpretation of Core Localized Alfvén Eigenmodes in DIII-D and Joint European Torus Reversed Magnetic Shear Plasmas,” *Phys. Plasmas* **13:5** (May 2006) Article No. 056104 (7 pages); invited paper at the *47th Annual Meeting of the American Physical Society, Division of Plasma Physics* (24-28 October 2005, Denver, CO).

Kramer, G.J., Nazikian, R., Valeo, E.J., Budny, R.V., Kessel, C., and Johnson, D., “2D Reflectometer Modeling for Optimizing the ITER Low-field Side X-mode Reflectometer System,” *Nucl. Fusion* **46:9** (September 2006) S846-S852; Special Issue on Reflectometry.

*Krasilnikov, A.V., Sasao, M., Kaschuck, Yu.A., Nishitani, T., Batistoni, P., Zaveriaev, V.S., Popovichev, S., Iguchi, T., Jarvis, O.N., Källne, J., Fiore, C.L., Roquemore, A.L., Heidbrink, W.W., Fisher, R., Gorini, G., Prosvirin, D.V., Tsutskikh, A.Yu., Donné, A.J.H., Costley, A.E., and Walker, C.I., “Status of ITER Neutron Diagnostic Development,” *Nucl. Fusion* **45:12** (December 2005) 1503-1509.

Krommes, J.A., “Analytical Descriptions of Plasma Turbulence,” in *Turbulence and Coherent Structures in Fluids, Plasmas and Nonlinear Media: Selected Lectures from the 19th Canberra International Physics Summer School*, edited by Michael Shats and Horst Punzmann, World Scientific Lecture Notes in Complex Systems **4** (World Scientific, Singapore, 2006) 115-232.

Krommes, J.A., “Statistical Plasma Physics in a Strong Magnetic Field: Paradigms and Problems,” in *Mathematical and Physical Theory of Turbulence*, edited by J. Cannon and B. Shivamoggi (Chapman & Hall, Boca Raton, FL, 2006) 69-90.

Krommes, J.A., “The Transition to Ion-temperature-gradient-driven Plasma Turbulence,” in *Turbulence and Coherent Structures in Fluids, Plasmas and Nonlinear Media: Proceedings of the COSNET Workshop*, edited by J. Denier and J. Frederikson (World Scientific, Singapore, 2006).

†Ku, L.P. and the ARIES-CS Team, “Modular Coil Design for the Ultra-low Aspect Ratio Quasi-axially Symmetric Stellarator MHH2,” in the *Proceedings of the 21st IEEE/NPSS Symposium on Fusion Engineering 2005* (26-29 September 2005, Knoxville, TN) 4 pp. Available from IEEE on CD-ROM, Digital Object Identifier 10.1109/FUSION.2005.252954 (posted online 4 December 2006).

†Ku, L.P. and the ARIES-CS Team, “Reactor Configuration Development for ARIES-CS,” in the *Proceedings of the 21st IEEE/NPSS Symposium on Fusion Engineering 2005* (26-29 September 2005, Knoxville, TN) 4 pp. Available from IEEE on CD-ROM, Digital Object Identifier 10.1109/FUSION.2005.252953 (posted online 4 December 2006).

Ku, L.P. and Garabedian, P.R., “New Classes of Quasi-Axisymmetric Stellarator Configurations,” *Fusion Sci. and Technol.* **50:2** (August 2006) 207-215; selected papers from the *15th International Stellarator Workshop* (3-7 October 2005, Madrid, Spain). Princeton Plasma Physics laboratory Report PPPL-4111 (October 2005) 16 pp.

*Kubota, N., Ochiai, K., Kutsukake, C., and 10 additional co-authors representing 2 institutions including Gentile, C.A. and Skinner, C.H. from PPPL, “Surface Analysis for the TFTR Armor Tile Exposed to D-T Plasmas using Nuclear Technique,” in the *Proceedings of the 21st Fusion Energy Conference (FEC 2006)*, (16-21 October 2006, Chengdu, People’s Republic of China) paper EX/P4-12. An unedited conference proceedings (IAEA CN-149) is available in electronic format on CD-ROM and in PDF format on the IAEA Physics Section web site at <http://www-naweb.iaea.org/napc/physics/FEC/FEC2006/html/index.htm> (active as of 19 July 2007).

*†Kubota, S., Peebles, W.A., Nguyen, X.V., Crocker, N.A., and Roquemore, A.L., “Ultrafast Millimeter-wave

Frequency-modulated Continuous-wave Reflectometry on NSTX,” *Rev. Sci. Instrum* **77**:10 (October 2006) Article No 10E926 (3 pp); *Proceedings of the 16th Topical Conference on High-Temperature Plasma Diagnostics* (7-11 May 2006, Williamsburg, VA).

Kugel, H.W., Bell, M.G., Bell, R., Bush, C., Gates, D., Gray, T., Kaita, R., LeBlanc, B., Maingi, R., Majeski, R., Mansfield, D., Mueller, D., Paul, S., Raman, R., Roquemore, A.L., Sabbagh, S., Skinner, C.H., Soukhanovskii, V., Stevenson, T., and Zakharov, L., “Effect of Lithium PFC Coatings on NSTX Density Control,” *J. Nucl. Mater.* **363-365** (15 June 2007) 791-796; *Proceedings of the 17th International Conference on Plasma-surface Interactions* 22-26 May 2006, Hefei, Anhui, China). Princeton Plasma Physics Laboratory Report PPPL-4180 (June 2006) 16 pp.

§Kugel, H.W., Spong, D., Majeski, R., and Zarnstorff, M., “NCSX Plasma Heating Methods,” *Fusion Sci. Technol.* **51**:2 (February 2007) 203-217.

†Kung, C.C., Kramer, G.J., Johnson, E., Solomon, W., and Nazikian, R., “Circuit Design to Stabilize the Reflectometer Local Oscillator Signals,” in the *Proceedings of the 21st IEEE/NPSS Symposium on Fusion Engineering 2005* (26-29 September 2005, Knoxville, TN) 4 pp. Available from IEEE on CD-ROM, Digital Object Identifier 10.1109/FUSION.2005.252974 (posted online 4 December 2006); Princeton Plasma Physics Laboratory Report PPPL-4113 (October 2005) 4 pp.

*Kurita, G., Bialek, J., Tuda, T., Azumi, M., Ishida, S., Navratil, G.A., Sakurai, S., Tamai, H., Matsukawa, M., Ozeki, T., Chu, M.S., Chance, M.S., and Miura, Y., “Critical Beta Analyses with Ferromagnetic and Plasma Rotation Effects and Wall Geometry for a High Beta Steady State Tokamak,” *Nucl. Fusion* **46**:2 (February 2006) 383-390.

†Kuritsyn, Alexey, Craig, Darren, Fiksel, Gennady, Miller, Matt, Cylinder, David, and Yamada, Masaaki, “Local Measurements of Plasma Ion Dynamics with Optical Probes,” *Rev. Sci. Instrum* **77**:10 (October 2006) Article No 10F112 (3 pp); *Proceedings of the 16th Topical Conference on High-Temperature Plasma Diagnostics* (7-11 May 2006, Williamsburg, VA).

Kuritsyn, A., Yamada, M., Gerhardt, S., Ji, H., Kulsrud, R., and Ren, Y., “Measurements of the Parallel and Transverse Spitzer Resistivities during Collisional Magnetic Reconnection,” *Phys. Plasmas* **13**:5 (May

2006) Article No. 055703 (5 pages); invited paper at the *47th Annual Meeting of the American Physical Society, Division of Plasma Physics* (24-28 October 2005, Denver, CO). Princeton Plasma Physics Laboratory Report PPPL-4149 (February 2006) 16 pp.

*Landsman, A.S., Cohen, S.A., and Glasser, A.H., “Onset and Saturation of Ion Heating by Odd-parity Rotating Magnetic Fields in a Field-reversed Configuration,” *Phys. Rev. Lett.* **96**:1 (3 January 2006) Article No. 015002; Princeton Plasma Physics Laboratory Report PPPL-4127 (November 2005) 10 pp.

*Lee, J., Gary, D.E., and Choe, G.S., “Magnetic Energy Release during the 2002 September 9 Solar Flare,” *Astrophys. J.* **647**:1 (10 August 2006) 638-647.

*†Lee, K.C., Domier, C.W., Johnson, M., Luhmann, Jr., N.C., Park, H., and Soukhanovskii, V.A., “Survey of Diagnostic System for the Study of Gyrocenter Shifts on National Spherical Torus Experiment,” *Rev. Sci. Instrum* **77**:10 (October 2006) Article No 10F505 (3 pages); *Proceedings of the 16th Topical Conference on High-Temperature Plasma Diagnostics* (7-11 May 2006, Williamsburg, VA).

Lee, W.W., Ethier, S., Jenkins, T.G., Wang, W.X., Lewandowski, J.L.V., Rewoldt, G., Tang, W.M., Parker, S.E. and Chen, Y., “Long Time Simulations of Microturbulence in Fusion Plasmas,” in the *Proceedings of the 21st Fusion Energy Conference (FEC 2006)*, (16-21 October 2006, Chengdu, People’s Republic of China) paper TH/2-6Rb. An unedited conference proceedings (IAEA CN-149) is available in electronic format on CD-ROM and in PDF format on the IAEA Physics Section web site at <http://www-naweb.iaea.org/napc/physics/FEC/FEC2006/html/index.htm> (active as of 19 July 2007).

Lewandowski, Jerome L.V., “A Marker Method for the Solution of the Damped Burgers’ Equation,” *Numerical Methods for Partial Differential Equations* **22**:1 (January 2006) 48-68; Princeton Plasma Physics Laboratory Report PPPL-4129 (November 2005) 26 pp.

Lewandowski, J.L.V., “Modeling Solution of Nonlinear Dispersive Partial Differential Equations using the Marker Method,” *International Journal for Computational Methods in Engineering Science and Mechanics* **6**:4 (October-December 2005) 271-283; Princeton Plasma Physics Laboratory Report PPPL-4046 (January 2005) 37 pp.

Lewandowski, J.L.V., Rewoldt, G., Ethier, S., Lee, W.W., and Lin, Z., “Global Particle-in-cell Simulations of Microturbulence with Kinetic Electrons,” *Phys. Plasmas* **13**:7 (July 2006) Article No. 072306 (7 pages).

*†Liu, D., Heidbrink, W.W., Darrow, D.S., Roquemore, A.L., Medley, S.S., and Shinohara, K., “Performance of the Solid State Neutral Particle Analyzer Array on the National Spherical Torus Experiment,” *Rev. Sci. Instrum* **77**:10 (October 2006) Article No 10F113 (4 pp); *Proceedings of the 16th Topical Conference on High-Temperature Plasma Diagnostics* (7-11 May 2006, Williamsburg, VA). Princeton Plasma Physics Laboratory Report PPPL-4174 (June 2006) 12 pp.

Liu, W., Goodman, J., and Ji, H., “Simulations of Magnetorotational Instability in a Magnetized Couette Flow,” *Astrophys. J.* **643**:1, Part 1 (20 May 2006) 306-317.

§Liu, Wei; Goodman, Jeremy; Herron, Isom; Ji, Hantao, “Helical Magnetorotational Instability in Magnetized Taylor-Couette Flow,” *Phys. Rev. E.* **74**:5 (November 2006) Article No. 056302 (13 pages).

*Liu, Yueqiang, Chu, M.S., Garofalo, A.M., LaHaye, R.J., Gribov, Y., Gryanznevich, M., Hender, T.C., Howell, D.F., de Vries, P., Okabayashi, M., Pinches, S.D., and Reimerdes, H., “Modeling of Resistive Wall Mode and its Control in Experiments and ITER,” *Phys. Plasmas* **13**:5 (May 2006) Article No. 056120 (9 pages); Invited paper at the *47th Annual Meeting of the American Physical Society, Division of Plasma Physics* (24-28 October 2005, Denver, CO).

*†Logan, B.G., Bieniosek, F., Celata, C.M., and 30 additional co-authors including Davidson, R.C., Efthimion, P.C., Gilson, E.P., Grisham, L.D., Kaganovich, I.D., Qin, H., Sefkow, A.B., and Startsev, E.A. from PPPL, “Recent U.S. Advances in Ion-beam-driven High Energy Density Physics and Heavy Ion Fusion,” *Nucl. Instrum. Methods Phys. Res. A: Accelerators, Spectrometers, Detectors and Associated Equipment* **577**:1-2 (1 July 2007) 1-7; *Proceedings of the 16th International Symposium on Heavy Ion Inertial Fusion*, HIF06 (9-14 July 2006, Saint-Malo, France).

*Luce, T.C., Burrell, K.H., Buttery, R.J., and 20 additional co-authors representing 8 institutions including Okabayashi, M. and Solomon, W.M. from PPPL, “Dependence of Confinement and Stability on Variation of the External Torque in the DIII-D Tokamak,” in the *Proceedings of the 21st Fusion Energy Conference*

(*FEC 2006*), (16-21 October 2006, Chengdu, People’s Republic of China) paper PD-3. An unedited conference proceedings (IAEA CN-149) is available in electronic format on CD-ROM and in PDF format on the IAEA Physics Section web site at <http://www-naweb.iaea.org/naweb/physics/FEC/FEC2006/html/index.htm> (active as of 19 July 2007).

*Lyon, J.F., et al., “Recent Advances in Design and R&D for the Quasi-Poloidal Stellarator Experiment,” presented at *24th Symposium on Fusion Technology*, (11-15 September 2006, Warsaw, Poland); to be published in *Fusion Engineering and Design*.

*Lyon, J.F., Ku, L.P., El-Guebaly, L., Bromberg, L., and the ARIES Team, “Optimizing Compact Stellarator Performance,” in the *Proceedings of the 33rd European Physical Society Conference on Plasma Physics* (19-23 June 2006, Roma, Italy), edited by F. De Marco and G. Vlad, Contributed Papers Vol. **301** (EPS 2006) P-4.197. The conference proceedings is available on CD-ROM. Papers are available in PDF format at <http://eps2006.frascati.enea.it/papers/start.htm> (active as of 2 July 2007).

*Maingi, R. and 31 additional co-authors including Bell, M.G., Fredrickson, E.D., Zweben, S.J., Bell, R.E., Gates, G.A., Johnson, D.W., Kaita, R., Kaye, S.M., Kugel, H.W., LeBlanc, B.P., Menard, J.E., Mueller, D., Park, H., Roquemore, A.L., and Stevenson, T., from PPPL, “Characterization of Small, Type V Edge-localized modes in the National Spherical Torus Experiment,” *Phys. Plasmas* **13**:9 (September 2006) Article No. 092510 (13 pages).

*†Maingi, R., Bush, C.E., Kaita, R., Kugel, H.W., Roquemore, A.L., Paul, S.F., Soukhanovskii, V.A., and NSTX Team, “Divertor Heat Flux Scaling with Heating Power and Plasma Current in H-mode Discharges in the National Spherical Torus Experiment,” *J. Nucl. Mater.* **363-365** (15 June 2007) 196-200; *Proceedings of the 17th International Conference on Plasma-surface Interactions* 22-26 May 2006, Hefei, Anhui, China).

*Maingi, R., Kaiser, T., Hill, D.N., Lyon, J.F., Monticello, D., and Zarnstorff, M.C., “Magnetic Field Line Tracing Calculations for Conceptual PFC Design in the National Compact Stellarator Experiment,” in the *Proceedings of the 33rd European Physical Society Conference on Plasma Physics* (19-23 June 2006, Roma, Italy), edited by F. De Marco and G. Vlad, Contributed Papers Vol. **301** (EPS 2006) P-5.116. The conference proceedings is available on CD-ROM. Papers are avail-

able in PDF format at <http://eps2006.frascati.enea.it/papers/start.htm> (active as of 2 July 2007).

Majeski, R., Doerner, R., Gray, T., Kaita, R., Maingi, R., Mansfield, D., Spaleta, J., Soukhanovskii, V., Timberlake, J., and Zakharov, L., “Enhanced Energy Confinement and Performance in a Low Recycling Tokamak,” *Phys. Rev. Lett.* **97**:7 (18 August 2006) 075002/1-4; Princeton Plasma Physics Laboratory Report PPPL-4164 (June 2006) 14 pp.

Majeski, R., Kugel, H., Bell, M.G., and 22 co-authors representing 6 institutions, “Results from the CDX-U Lithium Wall and NSTX Lithium Pellet Experiments,” in the *Proceedings of the 21st Fusion Energy Conference (FEC 2006)*, (16-21 October 2006, Chengdu, People’s Republic of China) paper EX/P4-23. An unedited conference proceedings (IAEA CN-149) is available in electronic format on CD-ROM and in PDF format on the IAEA Physics Section web site at <http://www-naweb.iaea.org/napc/physics/FEC/FEC2006/html/index.htm> (active as of 19 July 2007).

*Malyshkin, L., Linde, T., and Kulsrud, R.M., “Magnetic Reconnection with Anomalous Resistivity in Two-and-a half Dimensions I: Quasi-stationary Case,” *Phys. Plasmas* **12**:10 (October 2005) Article No. 102902 (14 pages).

*†Maqueda, R.J., Maingi, R., Tritz, K., Lee, K.C., Bush, C.E., Fredrickson, E.D., Menard, J.E., Roquemore, A.L., Sabbagh, S.A., and Zweben, S.J., “Structure of MARFES and ELMs in the NSTX,” *J. Nucl. Mater.* **363-365** (15 June 2007) 1000-1005; *Proceedings of the 17th International Conference on Plasma-surface Interactions* 22–26 May 2006, Hefei, Anhui, China).

*Marmor, E., Lin, Y., Lipschultz, B., Whyte, D., Bonoli, P., Fiore, C., Greenwald, M., Hutchinson, I., Irby, J., Reinke, M., Rice, J., Scott, S., Terry, J., Wolfe, S., Wukitch, S., and the Alcator Team, “Operation of Alcator C-Mod with High-Z Plasma Facing Components with and without Boronization,” in the *Proceedings of the 33rd European Physical Society Conference on Plasma Physics* (19-23 June 2006, Roma, Italy), edited by F. De Marco and G. Vlad, Contributed Papers Vol. **301** (EPS 2006) O-2.005. The conference proceedings is available on CD-ROM. Papers are available in PDF format at <http://eps2006.frascati.enea.it/papers/start.htm> (active as of 2 July 2007).

*†Marmor, E., Lin, Y., Lipschultz, B., Whyte, D., Bonoli, P., Fiore, C., Greenwald, M., Hutchinson, I.,

Irby, J., Reinke, M., Rice, J., Scott, S., Terry, J., Wolfe, S., Wukitch, S., and the Alcator Team, “Operation of Alcator C-Mod with High-Z Plasma Facing Components with and without Boronization,” in the *Proceedings of the 21st Fusion Energy Conference (FEC 2006)*, (16-21 October 2006, Chengdu, People’s Republic of China) paper EX/3-4. An unedited conference proceedings (IAEA CN-149) is available in electronic format on CD-ROM and in PDF format on the IAEA Physics Section web site at <http://www-naweb.iaea.org/napc/physics/FEC/FEC2006/html/index.htm> (active as of 19 July 2007).

*Martin, P., Fahrback, U., Garcia Muñoz, M., Günter, S., Zohm, H., Flaws, A., Gobbin, M., Igochine, V., Maraschek, M., Marrelli, L., Strumberger, E., White, R.B., and the ASDEX Upgrade Team, “Neoclassical Tearing Modes and Fast Ions Confinement,” in the *Proceedings of the 33rd European Physical Society Conference on Plasma Physics* (19-23 June 2006, Roma, Italy), edited by F. De Marco and G. Vlad, Contributed Papers Vol. **301** (EPS 2006) D-1.004. The conference proceedings is available on CD-ROM. Papers are available in PDF format at <http://eps2006.frascati.enea.it/papers/start.htm> (active as of 2 July 2007).

Mastrovito, D., Davis, W., Dong, J., Roney, P., and Sichta, P., “Integrating EPICS and MDSplus,” *Fusion Engineering and Design* **81**:15-17 (July 2006) 1847-1851; *Proceedings 5th IAEA Technical Meeting on Control, Data Acquisition, and Remote Participation for Fusion Research* (12-15 July 2005, Budapest, Hungary) edited by V. Schmidt.

§Mazzucato, E., “Detection of Short-scale Turbulence in the Next Generation of Tokamak Burning Plasma Experiments,” *Plasma Phys. Control. Fusion* **48**:12 (December 2006) 1749-1763; Princeton Plasma Physics Laboratory Report PPPL-4181 (June 2006) 14 pp.

Medley, S.S., Andre, R., Bell, R.E., Darrow, D.S., Fredrickson, E.D., LeBlanc, B.P., Levinton, F.M., Menard, J.E., Stutman, D., Roquemore, A.L., Shinohara, K., Tritz, K., and Yuh, H., “Investigation of Collective Fast Ion Instability-induced Redistribution of Loss in NSTX,” in the *Proceedings of the 21st Fusion Energy Conference (FEC 2006)*, (16-21 October 2006, Chengdu, People’s Republic of China) paper EX/P6-13. An unedited conference proceedings (IAEA CN-149) is available in electronic format on CD-ROM and in PDF format on the IAEA Physics Section web site at <http://www-naweb.iaea.org/napc/physics/FEC/FEC2006/html/index.htm> (active as of 19 July 2007).

Menard, J., Bell, M., Bell, R., Gates, D., Kaye, S., LeBlanc, B., Levinton, F., Maingi, R., Medley, S., Stutman, D., Sabbagh, S., Tritz, K., Yuh, H., and the NSTX Research Team, "Observation of MHD-induced Current Redistribution in NSTX," in the *Proceedings of the 33rd European Physical Society Conference on Plasma Physics* (19-23 June 2006, Roma, Italy), edited by F. De Marco and G. Vlad, Contributed Papers Vol. **301** (EPS 2006) O-2.002. The conference proceedings is available on CD-ROM. Papers are available in PDF format at <http://eps2006.frascati.enea.it/papers/start.htm> (active as of 2 July 2007).

Menard, J.E., Bell, M.G., Bell, R.E., the NSTX Research Team, and 45 additional co-authors representing 12 institutions, "Recent Physics Results from NSTX," in the *Proceedings of the 21st Fusion Energy Conference (FEC 2006)*, (16-21 October 2006, Chengdu, People's Republic of China) paper OV/2-4. An unedited conference proceedings (IAEA CN-149) is available in electronic format on CD-ROM and in PDF format on the IAEA Physics Section web site at <http://www-naweb.iaea.org/napc/physics/FEC/FEC2006/html/index.htm> (active as of 19 July 2007).

Menard, J.E., Bell, R.E., Gates, D.A., Kaye, S.M., LeBlanc, B.P., Levinton, F.M., Medley, S.S., Sabbagh, S.A., Stutman, D., Tritz, K., and Yuh, H., "Observation of Instability-induced Current Redistribution in a Spherical-torus Plasma," *Phys. Rev. Lett.* **97**:9 (1 September 2006) Article No. 095002; Princeton Plasma Physics Laboratory Report PPPL-4160 (May 2006) 12 pp.

§Mikkelsen, D.R., Maassberg, H., Zarnstorff, M.C., Beidler, C.D., Houlberg, W.A., Kernbichler, W., Mynick, H., Spong, D.A., Strand, P., and Tribaldos V., "Assessment of Transport in NCSX," *Fusion Sci. Technol.* **51**:2 (February 2007) 166-180.

*§Mioduszewski, P.K., Owen, L.W., Spong, D.A., Fenstermacher, M.E., Koniges, A.E., Rognlien, T.D., Umansky, M.V., Grossman, A., and Kugel, H.W., "Power and Particle Handling and Wall Conditioning in NCSX," *Fusion Sci. Technol.* **51**:2 (February 2007) 238-260.

†Mueller, D., Bell, M.G., Chrzanowski, J., Gates, D., Menard, J., Raman, R., Jarboe, T.R., Nelson, B.A., Maqueda, R.J., and Schaffer, M.J., "Design, Installation and Performance of the New Insulator for NSTX CHI Experiments," in the *Proceedings of the 21st IEEE/NPSS Symposium on Fusion Engineering 2005* (26-29

September 2005, Knoxville, TN) 4 pp. Available from IEEE on CD-ROM, Digital Object Identifier 10.1109/FUSION.2005.252951 (posted online 4 December 2006).

*†Munsat, T. and Zweben, S.J., "Derivation of Time-dependent Two-dimensional Velocity Field Maps for Plasma Turbulence Studies," *Rev. Sci. Instrum* **77**:10 (October 2006) Article No 103501 (13 pp).

*†Murakami, M., Greenfield, C.M., Wade, M.R., the DIII-D Team, and 38 additional co-authors representing 10 institutions including Kessel, C.E. and Menard, J.E., from PPPL, "100% Noninductive Operation at High Beta using Off-axis ECCD in DIII-D," *Nucl. Fusion* **45**:11 (November 2005) 1419-1426.

*Murakami, M., Wade, M.R., Greenfield, C.M., the DIII-D Team, and 39 additional co-authors including Kessel, C.E. of PPPL, "Progress toward Fully Noninductive, High Beta Conditions in DIII-D," *Phys. Plasmas* **13**:5 (May 2006) Article No. 056106 (9 pages); invited paper at the *47th Annual Meeting of the American Physical Society, Division of Plasma Physics* (24-28 October 2005, Denver, CO).

Mynick, H.E., "Transport Optimization in Stellarators," *Phys. Plasmas* **13**:5 (May 2006) Article No. 058102 (7 pages); tutorial paper at the *47th Annual Meeting of the American Physical Society, Division of Plasma Physics* (24-28 October 2005, Denver, CO); Princeton Plasma Physics Laboratory Report PPPL-4146 (February 2006) 26 pp.

Mynick, H.E., Boozer, A.H., and Ku, L.-P., "Improving confinement in Quasi-axisymmetric Stellarators," *Phys. Plasmas* **13**:6 (June 2006) Article No. 064505 (4 pages); Princeton Plasma Physics Laboratory Report PPPL-4162 (June 2006) 16 pp.

*Myra, J.R., Boedo, J., Coppi, B., and 9 additional co-authors representing 6 institutions including LeBlanc, B.P., Stotler, D.P., and Zweben, S.J. from PPPL, "Blob Transport Models, Experiments, and the Accretion Theory of Spontaneous Rotation," in the *Proceedings of the 21st Fusion Energy Conference (FEC 2006)*, (16-21 October 2006, Chengdu, People's Republic of China) paper TH/P6-21. An unedited conference proceedings (IAEA CN-149) is available in electronic format on CD-ROM and in PDF format on the IAEA Physics Section web site at <http://www-naweb.iaea.org/napc/physics/FEC/FEC2006/html/index.htm> (active as of 19 July 2007).

*Myra, J.R., D'Ippolito, D.A., Stotler, D.P., Zweben, S.J., LeBlanc, B.P., Menard, J.E., Maqueda, R.J., and Boedo, J., "Blob Birth and Transport in the Tokamak Edge Plasma: Analysis of Imaging Data," *Phys. Plasmas* **13**:9 (September 2006) Article No. 092509 (10 pages).

*Na, H.K., Her, N.I., Im, K.H., Kim, B.C., Young, K., and Park, H.K., "Analysis of Diagnostic Cassette and Development of Divertor H-alpha Monitor for KSTAR," in the *Proceedings of the 33rd European Physical Society Conference on Plasma Physics* (19-23 June 2006, Roma, Italy), edited by F. De Marco and G. Vlad, Contributed Papers Vol. **301** (EPS 2006) P-2.178. The conference proceedings is available on CD-ROM. Papers are available in PDF format at <http://eps2006.frascati.enea.it/papers/start.htm> (active as of 2 July 2007).

*Najmabadi, Farrokah, the ARIES Team, Abdou, A., and 32 additional co-authors from 8 institutions including Brown, T., Dahlgren, F., Heitzenroeder, P., and Kessel, C.E., from PPPL, "The ARIES-AT Advanced Tokamak, Advanced Technology Fusion Power Plant," *Fusion Eng. Des.* **80**:1-4 (January 2006) 3-23 (ARIES-AT Special Issue, A. Rene Raffray, editor).

*Nakajima, N., Hudson, S.R., Hegna, C.C., and Nakamura, Y., "Boundary Modulation Effects on MHD Instabilities in Heliotrons," *Nucl. Fusion* **46**:2 (February 2006) 177-199.

*Najmabadi, Farrokh; Raffray, A. Rene; Ku, Long-Poe; Lyon, James F., and ARIES Team, "Optimization of Compact Stellarator Configuration as Fusion Devices," *Phys. Plasmas* **13**:5 (May 2006) Article No. 056123 (12 pages); invited paper at the *47th Annual Meeting of the American Physical Society, Division of Plasma Physics* (24-28 October 2005, Denver, CO).

*Nakamura, Y., Tobita, K., Fukuyama, A., Takei, N., Takase, Y., Ozeki, T., and Jardin, S.C., "A Simulation Study on Inductive ITB Control in Reversed Shear Tokamak Discharges," *Nucl. Fusion* **46**:8 (August 2006) S645-S651.

Nazikian, R., Berk, H.L., Budny, R.V., Burrell, K.H., Doyle, E.J., Fonck, R.J., Gorelenkov, N.N., Holcomb, C., Kramer, G.J., Jayakumar, R.J., La Haye, R.J., McKee, G.R., Makowski, M.A., Peebles, W.A., Rhodes, T.L., Solomon, W.M., Strait, E.J., Van Zeeland, M.A., and Zeng, L., "Multitude of Core-localized Shear Alfvén Waves in a High-temperature Fusion Plasma," *Phys. Rev. Lett.* **96**:10 (17 March 2006) Article No. 105006.

†Neilson, G.H., Heitzenroeder, P., Lyon, J., Nelson, B., Reiersen, W., et al., "NCSX Construction Progress and Research Plans," in the *Proceedings of the 21st IEEE/NPSS Symposium on Fusion Engineering 2005* (26-29 September 2005, Knoxville, TN) 6 pp. Available from IEEE on CD-ROM, Digital Object Identifier 10.1109/FUSION.2005.252851 (posted online 4 December 2006).

Neilson, G.H., Nelson, B., Pomphrey, N., and 24 additional co-authors representing 3 institutions, "Progress in the Construction of NCSX," in the *Proceedings of the 21st Fusion Energy Conference (FEC 2006)*, (16-21 October 2006, Chengdu, People's Republic of China) paper FT/2-4. An unedited conference proceedings (IAEA CN-149) is available in electronic format on CD-ROM and in PDF format on the IAEA Physics Section web site at <http://www-naweb.iaea.org/napc/physics/FEC/FEC2006/html/index.htm> (active as of 19 July 2007).

*†Nelson, B., Benson, R., Berry, L., and 19 co-authors including Brooks, A., Goranson, P., Heitzenroeder, P., and Neilson, G. of PPPL, "Engineering Design Status of the Quasi-Poloidal Stellarator (QPS)," in the *Proceedings of the 21st IEEE/NPSS Symposium on Fusion Engineering 2005* (26-29 September 2005, Knoxville, TN) 5 pp. Available from IEEE on CD-ROM, Digital Object Identifier 10.1109/FUSION.2005.252856 (posted online 4 December 2006).

*Nelson, B.A., Raman, R., Jarboe, T.R., Mueller, D., Bell, M.G., and Maqueda, R., "Solenoid-free Plasma Start-up in HIT-II and NSTX using Transient CHI," in the *Proceedings of the 33rd European Physical Society Conference on Plasma Physics* (19-23 June 2006, Roma, Italy), edited by F. De Marco and G. Vlad, Contributed Papers Vol. **301** (EPS 2006) P-5.113. The conference proceedings is available on CD-ROM. Papers are available in PDF format at <http://eps2006.frascati.enea.it/papers/start.htm> (active as of 2 July 2007).

*Nelson, B.E., Lyon, J.F., Fogarty, P.J., and 11 additional co-authors representing 3 institutions including Heitzenroeder, P.J. and Neilson, G.H. from PPPL, "Innovation in Design and Fabrication of Compact Stellarators," in the *Proceedings of the 21st Fusion Energy Conference (FEC 2006)*, (16-21 October 2006, Chengdu, People's Republic of China) paper FT/P5-6. An unedited conference proceedings (IAEA CN-149) is available in electronic format on CD-ROM and in PDF format on the IAEA Physics Section web site at <http://>

www-naweb.iaea.org/napc/physics/FEC/FEC2006/html/index.htm (active as of 19 July 2007).

*Nemov, V.V., Kernbichler, W., Kasilov, S.V., Leitold, G.O., and Ku, L.P., "Assessment of the Trapped Particle Confinement in Optimized Stellarators," in the *Proceedings of the 33rd European Physical Society Conference on Plasma Physics (19-23 June 2006, Roma, Italy)*, edited by F. De Marco and G. Vlad, Contributed Papers Vol. **301** (EPS 2006) P-4.164. The conference proceedings is available on CD-ROM. Papers are available in PDF format at <http://eps2006.frascati.enea.it/papers/start.htm> (active as of 2 July 2007).

Neumeyer, C., Peng, Y-K.M., Kessel, C., and Rutherford, P., "Spherical Torus Design Point Studies," Princeton Plasma Physics Laboratory Report PPPL-4165 (June 2006) 44 pp.

†Neumeyer, C., Schmidt, J., Woolley, R., and Zatz, I., "Operational Experience with NSTX Demountable TF Joint," in the *Proceedings of the 21st IEEE/NPSS Symposium on Fusion Engineering 2005 (26-29 September 2005, Knoxville, TN)* 4 pp. Available from IEEE on CD-ROM, Digital Object Identifier 10.1109/FUSION.2005.252878 (posted online 4 December 2006).

*§Nevins, W.M., Candy, J., Cowley, S., Dannert, T., Dimits, A., Dorland, W., Estrada-Mila, C., Hammett, G.W., Jenko, F., Pueschel, M.J., and Shumaker, D.E., "Characterizing Electron Temperature Gradient Turbulence via Numerical Simulation," *Phys. Plasmas* **13**:12 (December 2006) Article No. 122306 (13 pages).

*Nevins, W.M., Hammett, G.W., Dimits, A.M., Dorland, W., and Shumaker, D.E., "Discrete Particle Noise in Particle-in-cell Simulations of Plasma Microturbulence," *Phys. Plasmas* **12**:12 (December 2005) Article No. 122305 (16 pages); UCRL-JRNL-212536 (August 2005).

*Nishimura, Y., Lin, Z., Lewandowski, J.L.V., and Ethier, S., "A Finite Element Poisson Solver for Gyrokinetic Particle Simulations in a Global Field Aligned Mesh," *J. Computational Physics* **214**:2 (May 20 2006) 657-671.

*†Nishino, N., Kaita, R., Roquemore, L., Maqueda, R., Zweben, S., Bush, C., Johnson, D., Kugel, H., Maingi, R., Soukhanovskii, V., and the NSTX Team, "NSTX Boundary Plasma Measurement by Fast Camera and Interpretations," in the *Proceedings of the 21st IEEE/NPSS Symposium on Fusion Engineering 2005 (26-29*

September 2005, Knoxville, TN) 6 pp. Available from IEEE on CD-ROM, Digital Object Identifier 10.1109/FUSION.2005.252963 (posted online 4 December 2006).

*Nishino, Nobuhiro; Roquemore, Lane; Biewer, Theodore M.; Zweben, Stewart J., Maqueda, Ricardo, Maingi, Rajesh; Bush, Charles; Tritz, Kevin; Stutman, Dan; and the NSTX Team, "Measurement of Edge Localized Mode using Fast Camera in NSTX," *IEEJ Trans. on Fundamentals and Materials* **125**:11 (November 2005) 902-907 [Special Issue on Spherical Tokamak (ST Workshop, Kyoto, Japan, 2004)].

*Oikawa, T., Shimada, M., Polevoi, A.R., Naito, O., Bonoli, P.T., Hayashi, N., Kessel, C.E., and Ozeki, T., "Study on Current Drive Capability of Lower Hybrid Waves and Neutral Beam in an ITER Steady State Scenario," in the *Proceedings of the 21st Fusion Energy Conference (FEC 2006)*, (16-21 October 2006, Chengdu, People's Republic of China) paper IT/P1-4. An unedited conference proceedings (IAEA CN-149) is available in electronic format on CD-ROM and in PDF format on the IAEA Physics Section web site at <http://www-naweb.iaea.org/napc/physics/FEC/FEC2006/html/index.htm> (active as of 19 July 2007).

Okabayashi, M., Bialek, J., Bondeson, A., and 22 additional co-authors from 7 institutions including Chance, M.S., Hatcher, R., Manickam, J., and Menard, J. from PPPL, "Control of the Resistive Wall Mode with Internal Coils in the DIII-D Tokamak," *Nucl. Fusion* **45**:12 (December 2005) 1715-1731.

*Oliver, H.J., Reiman, A.H., and Monticello, D.A., "Solving the 3D MHD Equilibrium Equations in Toroidal Geometry by Newton's Method," *J. Computational Physics* **211**:1 (1 January 2006) 99-128.

*Ongena, J., Evrard, M., and McCune, D., "Numerical Transport Codes," *Fusion Sci. Technol.* **49**:2T (February 2006) 337-345.

Ono, M., Bell, M.G., Bell, R.E. and 47 co-authors from 32 institutions, "Status and Plans for the National Spherical Torus Experimental Research Facility," *IEEJ Trans. on Fundamentals and Materials* **125**:11 (November 2005) 868-880 [Special Issue on Spherical Tokamak (ST Workshop, Kyoto, Japan, 2004)].

Park, H., Luhmann, Jr., N.C., Donn e, A.J.H., Classen, I.G.J., Domier, C.W., Mazzucato, E., Munsat, T., Van de Pol, M.J., Xia, Z., and the TEXTOR Team, "New

Paradigm for the $m/n=1/1$ (“Sawtooth Oscillation”) Based on High Resolution 2-D Images of Te Fluctuations and Comparisons with Theoretical Models,” in the *Proceedings of the 21st Fusion Energy Conference (FEC 2006)*, (16-21 October 2006, Chengdu, People’s Republic of China) paper PD/P6-1. An unedited conference proceedings (IAEA CN-149) is available in electronic format on CD-ROM and in PDF format on the IAEA Physics Section web site at <http://www.naweb.iaea.org/napc/physics/FEC/FEC2006/html/index.htm> (active as of 19 July 2007).

Park, H.K., Donné, A.J.H., Luhmann, Jr., N.C., Classen, I.G.J., Domier, C.W., Mazzucato, E., Munsat, T., van de Pol, M.J., Xia, Z., and the TEXTOR Team, “Comparison Study of 2-D Images of Temperature Fluctuations during the Sawtooth Oscillation with Theoretical Models,” *Phys. Rev. Lett.* **96**:19 (19 May 2006) Article No.195004 Princeton Plasma Physics Laboratory Report PPPL-4158 (April 2006) 12 pp.

Park, H.K., Luhmann, Jr., N.C., Donné, A.J.H., Classen, I.G.J., Domier, C.W., Mazzucato, E., Munsat, T., van de Pol, M.J., Xia, Z., and the TEXTOR Team, “Observation of High-field-side Crash and Heat Transfer during Sawtooth Oscillation in Magnetically Confined Plasmas,” *Phys. Rev. Lett.* **96**:19 (19 May 2006) Article No. 195003.

Park, H.K., Luhmann, Jr., N.C., Donné, A.J.H., Classen, I.G.J., Domier, C.W., Mazzucato, E., Munsat, T., van de Pol, M.J., Xia, Z., and the TEXTOR Team, “First Observation of the High Field Side Sawtooth Crash and Heat Transfer during Driven Reconnection Processes in Magnetically Confined Plasmas,” Princeton Plasma Physics Laboratory Report PPPL-4135 (December 2005) 14 pp.

Park, H.K., Mazzucato, E., Luhmann, Jr., N.C., Domier, C.W., Xia, Z., Munsat, T., Donné, A.J.H., Classen, I.G.J., van de Pol, M.J., and the TEXTOR Team, “Self-organized T_e Redistribution during Driven Reconnection Processes in High Temperature Plasmas,” *Phys. Plasmas* **13**:5 (May 2006) Article No. 055907 (12 pages); invited paper at the *47th Annual Meeting of the American Physical Society, Division of Plasma Physics* (24-28 October 2005, Denver, CO). Princeton Plasma Physics Laboratory Report PPPL-4134 (December 2005) 24 pp.

*†Parker, C.V., Skinner, C.H., and Roquemore, A.L., “Controlling Surface Dust in a Tokamak,” *J. Nucl. Mater.* **363-365** (15 June 2007) 1461-1465; *Proceedings*

of the 17th International Conference on Plasma-surface Interactions 22-26 May 2006, Hefei, Anhui, China); Princeton Plasma Physics Laboratory Report PPPL-4169 (June 2006) 12 pp.

†Paul, S.F. and Marsala, R., “Updated Design for a Low-noise, Wideband Transimpedance Photodiode Amplifier,” *Rev. Sci. Instrum* **77**:10 (October 2006) Article No 10E528 (3 pp); *Proceedings of the 16th Topical Conference on High-Temperature Plasma Diagnostics* (7-11 May 2006, Williamsburg, VA).

*Pederson, Sunn T., Kremer, J.P., Lefrancois, R.G., Marksteiner, Q., Pomphrey, N., Reiersen, W., Dahlgren, E., and Sarasola, Xabier, “Construction and Initial Operation of the Columbia Nonneutral Torus,” *Fusion Sci. and Technol.* **50**:3 (October 2006) 372-381; presented at the *15th International Stellarator Workshop* (3-7 October 2005, Madrid, Spain).

*Peng, Y-K.M., Fogarty, P.J., Burgess, T.W., Strickler, D.J., Nelson, B.E., Tsai, J., Neumeyer, C.A., Bell, R., Kessel, C., Menard, J., Gates, D., LeBlanc, B., Mikkelsen, D., Fredrickson, E., Grisham, L., Schmidt, J., Rutherford, P., Sabbagh, S., Field, A., Sykes, A., Cook, I., Mitarai, O., and Takase, Y., “A Component Test Facility Based on the Spherical Tokamak,” *Special Issue Plasma Phys. Control. Fusion* **47**:12B (December 2005) B263-B283; invited papers at the *32nd European Physical Society Conference on Plasma Physics* (27 June-1 July 2005, Tarragona, Spain).

Peng, Y-K.M., Fogarty, P.J., Burgess, T.W., Strickler, D.J., Tsai, J., Neumeyer, C.A., Kessel, C., Rutherford, P., Schmidt, J., Mikkelsen, D., Menard, J., Gates, D., Bell, R., LeBlanc, B., Synakowski, E., Grisham, L., Sabbagh, S., Mitarai, O., and El-Guebaly, L., “Spherical Tokamak Plasma Science and Fusion Energy Component Testing,” *IEEE Trans. on Fundamentals and Materials* **125**:11 (November 2005) 857-867 [Special Issue on Spherical Tokamak (ST Workshop, Kyoto, Japan, 2004)].

*†Pinches, S.D., Kiptily, V.G., Sharapov, S.E., Darrow, D.S., Eriksson, L.-G., Fahrback, H.-U., Garcia-Muñoz, M., Reich, M., Strumberger, E., Werner, A., and the ASDEX Upgrade Team and JET-EFDA Contributors, “Observation and Modelling of Fast Ion Loss in JET and ASDEX Upgrade,” *Nucl. Fusion* **46**:10 (October 2006) S904-S910; presented at *9th IAEA Technical Meeting on Energetic Particles in Magnetic Confinement Systems* (9-11 November 2005, Takayama, Japan).

*Pinsker, R.I., Porkolab, M., Heidbrink, W.W., Luo, Y., Petty, C.C., Prater, R., Choi, M., Schaffner, D.A., Baity, F.W., Fredd, E., Hosea, J.C., Harvey, R.W., Smirnov, A.P., Murakami, M., and Van Zeeland, M.A., “Absorption of Fast Waves at Moderate to High Ion Cyclotron Harmonics on DIII-D,” Nucl. Fusion **46**:7 (July 2006) S416-S424 (Special Section on the Physics and Technology of Plasma Heating by ICRF Power.)

*Pitts, R.A., Coad, J.P., Coster, D.P., the JET-EFDA Contributors, and 9 additional co-authors from 7 institutions including Strachan, J.D. from PPPL, “Material Erosion and Migration in Tokamaks,” Special Issue Plasma Phys. Control. Fusion **47**:12B (December 2005) B303-B322; invited paper at the *32nd European Physical Society Conference on Plasma Physics* (27 June-1 July 2005, Tarragona, Spain).

*§Polomarov, Oleg; Sefkow, Adam B.; Kaganovich, Igor; Shvets, Gennady, “Computationally Efficient Description of Relativistic Electron Beam Transport in Collisionless Plasma,” Phys Plasmas **14**:4 (April 2007) Article No. 043103 (10 pages).

*Polomarov, O.V., Theodosiou, C.E., Kaganovich, I.D., Economou, D.J., and Ramamurthi, B.N., “Self-consistent Modeling of Nonlocal Inductively Coupled Plasmas,” IEEE Trans. Plasma Sci. **34**:3, Part 2 (June 2006) 767-785; presented at the *Workshop on Nonlocal, Collisionless Electron Transport in Plasmas* (2-4 August 2005, Princeton, NJ).

*Polomarov, O.V., Theodosiou, C.E., Kaganovich, I.D., Ramamurthi, B.N., and Economou, D.J., “Effectiveness of Electron-cyclotron and Transmission Resonance Heating in Inductively Coupled Plasmas,” Phys. Plasmas **12**:10 (October 2005) Article No. 104505 (4 pages).

*Polzin, K.A., Markusic, T.E., Stanojev, B.J., Dehoyos, A., Raitses, Y., Smirnov, A., and Fisch, N.J., “Performance of a Low Power Cylindrical Hall Thruster,” in the *Proceedings of the 29th International Electric Propulsion Conference (IEPC05)*, (31 October - 4 November 2005, Princeton, NJ) IEPC-2005-011.

§Pomphrey, N., Boozer, A., Brooks, A., Hatcher, R., Hirshman, S.P., Hudson, S., Ku, L.-P., Lazarus, E.A., Mynick, H., Monticello, D., Redi, M., Reiman, A., Zarnstorff, M.C., and Zatz, I., “NCSX Magnetic Configuration Flexibility and Robustness,” Fusion Sci. Technol. **51**:2 (February 2007) 181-202.

Pomphrey, N., Lazarus, E.A., Zarnstorff, M.C., Brooks, A., Boozer, A., and Fredrickson, E., “Magnetic Flux Loop Design for NCSX,” in the *Proceedings of the 33rd European Physical Society Conference on Plasma Physics* (19-23 June 2006, Roma, Italy), edited by F. De Marco and G. Vlad, Contributed Papers Vol. **301** (EPS 2006) P-5.122. The conference proceedings is available on CD-ROM. Papers are available in PDF format at <http://eps2006.frascati.enea.it/papers/start.htm> (active as of 2 July 2007).

*Porkolab, M., Edlund, E., Lin, L., and 10 additional co-authors representing 5 institutions including Gorelenkov, N. and Kramer, G.J. from PPPL, “Experimental Studies and Analysis of Alfvén Eigenmodes in Alcator C-Mod,” in the *Proceedings of the 21st Fusion Energy Conference (FEC 2006)*, (16-21 October 2006, Chengdu, People’s Republic of China) paper EX/P6-16. An unedited conference proceedings (IAEA CN-149) is available in electronic format on CD-ROM and in PDF format on the IAEA Physics Section web site at <http://www-naweb.iaea.org/napc/physics/FEC/FEC2006/html/index.htm> (active as of 19 July 2007).

*Prager, S.C., Adney, J., Almagri, A., and 41 co-authors representing 8 institutions and including White, R. from PPPL, “Overview of results in the MST reversed field pinch experiment,” Special Issue Nucl. Fusion **45**:10 (October 2005) S276-S282 [Overview and Summary Reports based on the 2004 Fusion Energy Conference Contributions (1-6 November 2004, Vilamoura, Portugal)].

*†Preinhaelter, Josef; Urban, Jakob; Pavlo, Pavol; Taylor, Gary; Diem, Steffi; Vahala, Linda; and Vahala, George, “Electron Bernstein Wave Simulations and Comparison to Preliminary NSTX Emission Data,” Rev. Sci. Instrum **77**:10 (October 2006) Article No. 10F524 (4 pp); *Proceedings of the 16th Topical Conference on High-Temperature Plasma Diagnostics* (7-11 May 2006, Williamsburg, VA).

Qin, H. and Davidson, R.C., “An Exact Magnetic-Moment Invariant of Charged-Particle Gyromotion,” Phys. Rev. Lett. **96** (3 March 2006) Article No. 085003/1-4; Princeton Plasma Physics Laboratory Report PPPL-4155 (March 2006) 4 pp.

Qin, H. and Davidson, R.C., “Symmetries and Invariants of the Oscillator Equation and the Envelope Equation with Time-dependent Frequency,” Phys. Rev. ST Accel. Beams **9**:5 (May 2006) Article No. 054001 (5 pages).

†Qin, Hong; Davidson, Ronald C.; and Startsev, Edward A., “Nonlinear δf Particle Simulations of Collective Effects in High-Intensity Bunched Beams,” *Nucl. Instrum. Methods Phys. Res. A: Accelerators, Spectrometers, Detectors and Associated Equipment* **577**:1-2 (1 July 2007) 86-92; *Proceedings of the 16th International Symposium on Heavy Ion Inertial Fusion*, HIF06 (9-14 July 2006, Saint-Malo, France).

Raitses, Y., Smirnov, A., and Fisch, N.J., “Cylindrical Hall Thrusters,” in the *Proceedings of the 37th AIAA Plasmadynamics and Lasers Conference* (5-8 June 2006, San Francisco, CA) AIAA-2006: 3245.

Raitses, Y., Smirnov, A., and Fisch, N.J., “Segmented Electrodes in Annual and Cylindrical Hall Thrusters,” in the *Proceedings of the 42th AIAA/ASME/SAE/ASEE Joint Propulsion Conference and Exhibit* (9-12 July 2006, Sacramento, CA) AIAA-2006: 4471.

Raitses, Y., Smirnov, A., Staack, D., and Fisch, N.J., “Measurements of Secondary Electron Emission Effects in the Hall Thruster Discharge,” *Phys. Plasmas* **13**:1, (January 2006) Article No. 014502 (4 pages); Princeton Plasma Physics Laboratory Report PPPL-4137 (December 2005) 14 pp.

Raitses, Y., Staack, D., Dunaevsky, A., and Fisch, N.J., “Operation of a Segmented Hall Thruster with Low-sputtering Carbon-velvet Electrodes,” *J. Appl. Phys.* **99**:3 (1 February 2006) Article No. 036103 (3 pages); Princeton Plasma Physics Laboratory Report PPPL-4136 (December 2005) 20 pp.

Ramakrishnan, S., Neumeyer, C., Marsala, R., Hatcher, R., and Baker, E., “Power Supply for NSTX Resistive Wall Mode Coils,” in the *Proceedings of the 21st IEEE/NPSS Symposium on Fusion Engineering 2005* (26-29 September 2005, Knoxville, TN) 4 pp. Available from IEEE on CD-ROM, Digital Object Identifier 10.1109/FUSION.2005.252896 (posted online 4 December 2006).

*Raman, R., Jarboe, T.R., Mueller, D., Nelson, B.A., Bell, M.B., Ono, M., Bigelow, T., Kaita, R., LeBlanc, B., Maqueda, R., Menard, J., Paul, S., and Roquemore, L., “Solenoid-free Plasma Start-up in NSTX using Transient CHI,” in the *Proceedings of the 21st Fusion Energy Conference (FEC 2006)*, (16-21 October 2006, Chengdu, People’s Republic of China) paper EX/P8-16. An unedited conference proceedings (IAEA CN-149) is available in electronic format on CD-ROM and in PDF format on the IAEA Physics Section web site at <http://www-naweb.iaea.org/napc/physics/FEC/FEC2006/html/index.htm> (active as of 19 July 2007).

www-naweb.iaea.org/napc/physics/FEC/FEC2006/html/index.htm (active as of 19 July 2007).

*†Raman, R., Jarboe, T.R., Nelson, B.A., Bell, M.G., and Mueller, D., “Solenoid-free Plasma Start-up in Hit-II and NSTX using Transient CHI,” *J. Fusion Energy* **26**:1-2 (June 2007) 159-162; presented at the *Innovative Confinement Concepts Workshop* (13-16 February 2006, Austin, Texas).

*Raman, Roger; Jarboe, Thomas R.; Bell, Michael G.; Mueller, Dennis; Nelson, Brian A.; LeBlanc, Benoit P.; Bush, Charles; Nagata, Mayayoshi; and Biewer, Theodor M.; “Solenoid-free Plasma Startup in NSTX using Coaxial Helicity Injection,” *IEEE Trans. on Fundamentals and Materials* **125**:11 (November 2005) 895-901 [Special Issue on Spherical Tokamak (ST Workshop, Kyoto, Japan, 2004)].

*§Raman, R., Nelson, B.A., Bell, M.G., Jarboe, T.R., Mueller, D., Bigelow, T., LeBlanc, B., Maqueda, R., Menard, J., Ono, M., and Wilson, R., “Efficient Generation of Closed Magnetic Flux Surfaces in a Large Spherical Tokamak using Coaxial Helicity Injection,” accepted for publication in *Phys. Rev. Lett.* **97**:17 (27 October 2006) Article No. 175002.

*Razdobarin, G.T., Walsh, M.J., Hatae, T., Mukhin, E.E., Narihara, K., Vayakis, G., Johnson, D., Carlstrom, T., and the ITPA Specialists Working Group on Thomson Scattering, representing 7 institutions, “Progress in Development of Thomson Scattering Systems for ITER,” in the *Proceedings of the 21st Fusion Energy Conference (FEC 2006)*, (16-21 October 2006, Chengdu, People’s Republic of China) paper IT/P1-25. An unedited conference proceedings (IAEA CN-149) is available in electronic format on CD-ROM and in PDF format on the IAEA Physics Section web site at <http://www-naweb.iaea.org/napc/physics/FEC/FEC2006/html/index.htm> (active as of 19 July 2007).

*Reich, M., Bäuml, S., Darrow, D., Fahrbach, H.-U., Fullard, K., García-Muñoz, Kiptily, V., Werner, A., ASEX Upgrade Team and JET-EFDA Contributors, “Ion Loss Measurements with Scintillator Probes at JET and ASDEX Upgrade,” in the *Proceedings of the 33rd European Physical Society Conference on Plasma Physics* (19-23 June 2006, Roma, Italy), edited by F. De Marco and G. Vlad, Contributed Papers Vol. **301** (EPS 2006) P-2.131. The conference proceedings is available on CD-ROM. Papers are available in PDF format at <http://eps2006.frascati.enea.it/papers/start.htm> (active as of 2 July 2007).

Reiersen, W., Heitzenroeder, P., Neilson, G.H., Nelson, B., Zarnstorff, M., Brown, T., Cole, M., Chrzanowski, J., Fogarty, P., Goranson, P., Lyon, J., Schmidt, J., Strykowski, R., Viola, M., and Williamson, D., "Progress in NCSX and QPS Design and Construction," Princeton Plasma Physics Laboratory Report PPPL-4120 (October 2005) 8 pp; presented at the *15th International Stellarator Workshop* (3-7 October 2005, Madrid, Spain).

†Reiersen, W.T. and Neilson, G.H., "Engineering Management Lessons on NCSX," in the *Proceedings of the 21st IEEE/NPSS Symposium on Fusion Engineering 2005* (26-29 September 2005, Knoxville, TN) 4 pp. Available from IEEE on CD-ROM, Digital Object Identifier 10.1109/FUSION.2005.252893 (posted online 4 December 2006).

§Reiman, A., Hirshman, S., Hudson, S., Monticello, D., Rutherford, P., Boozer, A., Brooks, A., Hatcher, R., Ku, L., Lazarus, E.A., Neilson, H., Strickler, D., White, R., and Zarnstorff, M., "Equilibrium and Flux Surface Issues in the Design of the National Compact Stellarator Experiment," *Fusion Sci. Technol.* **51**:2 (February 2007) 145-165.

Reiman, A., Zarnstorff, M., Monticello, D., Weller, A., Geiger, J., Krommes, J., and the W7-AS Team, "Localized Breaking of Flux Surfaces and the Equilibrium Beta Limit in the W7AS Stellarator," in the *Proceedings of the 21st Fusion Energy Conference (FEC 2006)*, (16-21 October 2006, Chengdu, People's Republic of China) paper TH/P7-3. An unedited conference proceedings (IAEA CN-149) is available in electronic format on CD-ROM and in PDF format on the IAEA Physics Section web site at <http://www-naweb.iaea.org/naweb/physics/FEC/FEC2006/html/index.htm> (active as of 19 July 2007).

*Reimerdes, H., Hender, T.C., Sabbagh, S.A., the DIII-D Team, the JET-EFDA Contributors, the NSTX Team and 25 additional co-authors from 8 institutions including Menard, J.E., Okabayashi, M., Gates, D.A., Mueller, D., and Solomon, W.M. of PPPL, "Cross-machine Comparison of Resonant Field Amplification and Resistive Wall Mode Stabilization by Plasma Rotation," *Phys. Plasmas* **13**:5 (May 2006) Article No. 056107 (11 pages); invited paper at the *47th Annual Meeting of the American Physical Society, Division of Plasma Physics* (24-28 October 2005, Denver, CO).

Rewoldt, G., Ku, L.-P., and Tang, W.M., "Comparison of Microinstability Properties for Stellarator

Magnetic Geometries," *Phys. Plasmas* **12**:10 (October 2005) Article No. 102512 (10 pages); Princeton Plasma Physics Laboratory Report PPPL-4082 (June 2005) 26 pp.

†Roquemore, L.A., Nishino, N., Skinner, C.H., Bush, C., Kaita, R., Maqueda, R., Davis, W., Pigarov, A.Yu., and Krasheninnikov, S.I., "3D Measurements of Mobile Dust Particle Trajectories in NSTX," *J. Nucl. Mater.* **363-365** (15 June 2007) 222-226; *Proceedings of the 17th International Conference on Plasma-surface Interactions* 22-26 May 2006, Hefei, Anhui, China).

†Roquemore, L.A., Davis, W., Kaita, R., Skinner, C.H., Maqueda, R., and Nishino, N., "Imaging of High-speed Dust Particle Trajectories on NSTX," *Rev. Sci. Instrum.* **77**:10 (October 2006) Article No 10E526 (3 pp); *Proceedings of the 16th Topical Conference on High-Temperature Plasma Diagnostics* (7-11 May 2006, Williamsburg, VA).

*Roy, P.K., Yu, S.S., Henestroza, E., Anders, A., Bieniosek, F.M., Coleman, J., Eylon, S., Greenway, W.G., Leitner, M., Logan, B.G., Waldron, W.L., Welch, D.R., Thoma, C., Sefkow, A.B., Gilson, E., Efthimion, P.C., and Davidson, R.C., "Drift Compression of an Intense Neutralized Ion Beam," *Phys. Rev. Lett.* **95**:23 (2 December 2005) Article No. 234801/1-4.

*Roy, Prabir K.; Waldron, William L.; Yu, Simon S.; and 16 additional co-authors including Davidson, Ronald C. from PPPL, "Energy Amplification and Beam Bunching in a Pulse Line Ion Accelerator," *Phys. Rev. ST Accel. Beams* **9**:7 (July 2006) Article No. 070402 5 pages).

*†Roy, P.K., Yu, S.S., Waldron, W., and 20 additional co-authors including Davidson, R.C., Efthimion, P.C., Gilson, E.P., Kaganovich, I., and Sefkow, A.B. from PPPL, "Neutralized Drift Compression Experiments (NDCX) with a High Intensity Ion Beam," *Nucl. Instrum. Methods Phys. Res. A: Accelerators, Spectrometers, Detectors and Associated Equipment* **577**:1-2 (1 July 2007) 223-230; *Proceedings of the 16th International Symposium on Heavy Ion Inertial Fusion, HIF06* (9-14 July 2006, Saint-Malo, France).

*Sabbagh, S.A., Bell, R.E., Menard, J.E., Gates, D.A., Sontag, A.C., Bialek, J.M., LeBlanc, B.P., Levinton, F.M., Tritz, K., and Yuh, H., "Active Stabilization of the Resistive-wall Mode in High-beta Low-rotation Plasmas," *Phys. Rev. Lett.* **97**:4 (28 July 2006) Article No. 045004.

*Sabbagh, S.A., Bell, R.E., Menard, J.E., Gates, D.A., Sontag, A.C., Bialek, J.M., LeBlanc, B.P., Levinton, F.M., Tritz, K., and Yuh, H., "Resistive Wall Mode Active Stabilization in High Beta, Low Rotation Plasmas," in the *Proceedings of the 21st Fusion Energy Conference (FEC 2006)*, (16-21 October 2006, Chengdu, People's Republic of China) paper PD/P6-2. An unedited conference proceedings (IAEA CN-149) is available in electronic format on CD-ROM and in PDF format on the IAEA Physics Section web site at <http://www-naweb.iaea.org/napc/physics/FEC/FEC2006/html/index.htm> (active as of 19 July 2007).

*Sabbagh, S.A., Sontag, A.C., Bialek, J.M., Gates, D.A., Glasser, A.H., Menard, J.E., Zhu, W., Bell, M.G., Bell, R.E., Bondeson, A., Bush, C.E., Callen, J.D., Chu, M.S., Hegna, C.C., Kaye, S.M., Lao, L.L., LeBlanc, B.P., Liu, Y.Q., Maingi, R., Mueller, D., Shaing, K.C., Stutman, D., Tritz, K., and Zhang, C., "Resistive Wall Stabilized Operation in Rotating High Beta NSTX Plasmas," *Nucl. Fusion* **46**:5 (May 2006) 635-644.

Scott, S., Bader, A., Bakhtiari, M., and 85 additional co-authors representing 18 institutions, "Overview of Alcator C-Mod Research Program," in the *Proceedings of the 21st Fusion Energy Conference (FEC 2006)*, (16-21 October 2006, Chengdu, People's Republic of China) paper OV/3-2. An unedited conference proceedings (IAEA CN-149) is available in electronic format on CD-ROM and in PDF format on the IAEA Physics Section web site at <http://www-naweb.iaea.org/napc/physics/FEC/FEC2006/html/index.htm> (active as of 19 July 2007).

Sefkow, Adam B. and Davidson, Ronald C., "Theoretical Models for Describing Longitudinal Bunch Compression in the Neutralized Drift Compression Experiment," *Phys. Rev. ST Accel. Beams* **9**:9 (September 2006) Article No. 090101 (13 pages).

Sefkow, A.B., Davidson, R.C., Efthimion, P.C., Gilson, E.P., Yu, S.S., Roy, P.K., Bieniosek, F.M., Coleman, J.E., Eylon, S., Greenway, W.G., Henestroza, E., Kwan, J.W., Vaneccek, D.L., Waldron, W.L., and Welch, D.R., "A Fast Faraday Cup to Measure Neutralized Drift Compression in Intense Ion Charge Bunches," *Phys. Rev. ST Accel. Beams* **9**:5 (May 2006) Article No. 052801 (9 pages).

†Sefkow, Adam B.; Davidson, Ronald C.; Kaganovich, Igor D.; Gilson, Erik P.; Roy, Prabir K.; Seidl, Peter A.; Yu, Simon S.; Welch, Dale R.; Rose, David V.; and Barnard, John J., "Optimized Simultaneous Transverse

and Longitudinal Focusing of Intense Ion Beam Pulses for Warm Dense Matter Applications," *Nucl. Instrum. Methods Phys. Res. A: Accelerators, Spectrometers, Detectors and Associated Equipment* **577**:1-2 (1 July 2007) 289-297; *Proceedings of the 16th International Symposium on Heavy Ion Inertial Fusion*, HIF06 (9-14 July 2006, Saint-Malo, France).

*†Seidl, P.A., Armijo, J., Baca, D., and 21 additional co-authors including Davidson, R.C., Efthimion, P.C., Gilson, E.P., Kaganovich, I., and Sefkow, A.B. from PPPL, "Plans for the Neutralized Drift Compression Experiment and Initial Results from Solenoid Transport," *Nucl. Instrum. Methods Phys. Res. A: Accelerators, Spectrometers, Detectors and Associated Equipment* **577**:1-2 (1 July 2007) 215-222; *Proceedings of the 16th International Symposium on Heavy Ion Inertial Fusion*, HIF06 (9-14 July 2006, Saint-Malo, France).

Sharma, P., "Kinetic Effects on Turbulence Driven by the Magnetorotational Instability in Black Hole Accretion," Ph.D. Dissertation, Princeton University (August 2006).

Sharma, P., Hammett, G.W., Quataert, E., and Stone, J.M., "Shearing Box Simulations of the MRI in a Collisionless Plasma," *Astrophys. J.* **637**:2 Part 1 (1 February 2006) 952-967; Princeton Plasma Physics Laboratory Report PPPL-4098 (August 2005) 20 pp.

*†Shinohara, K., Isobe, M. and Darrow, D.S., "Escaping Ion Measurement with High Time Resolution on CHS," *Rev. Sci. Instrum* **77**:10 (October 2006) Article No 10E521 (4 pp); *Proceedings of the 16th Topical Conference on High-Temperature Plasma Diagnostics* (7-11 May 2006, Williamsburg, VA).

†Sichta, P., Dong, J., Lawson, J.E., Oliaro, G., and Wertenbaker, J., "Development of a Universal Networked Timer at NSTX," in the *Proceedings of the 21st IEEE/NPSS Symposium on Fusion Engineering 2005* (26-29 September 2005, Knoxville, TN) 4 pp. Available from IEEE on CD-ROM, Digital Object Identifier 10.1109/FUSION.2005.252973 (posted online 4 December 2006).

†Skinner, C.H. and Federici, G., "Is Carbon a Realistic Choice for ITER's divertor?," *Phys. Scr.* **T124** (May 2006) 18-22; *Workshop on New Directions for Advanced Computer Simulations and Experiments in Fusion-related Plasma-surface Interactions* (21-23 March 2005, Oak Ridge National Laboratory, TN).

Skinner, C.H., Kugel, H.W., Roquemore, A.L., Maingi, R., and Wampler, W.R., "Pulse-by-pulse Measurements of Dynamic Retention and Deposition in NSTX," *J. Nucl. Mater.* **363-365** (15 June 2007) 274-251; *Proceedings of the 17th International Conference on Plasma-surface Interactions* 22-26 May 2006, Hefei, Anhui, China); Princeton Plasma Physics Laboratory Report PPPL-4168 (June 2006) 14 pp.

Smirnov, A., "Experimental and Theoretical Studies of Cylindrical Hall Thrusters," Ph.D. Dissertation, Princeton University (July 2006).

Smirnov, A., Raiteses, Y., and Fisch, N.J., "Electron Cross-field Transport in a Miniaturized Cylindrical Hall Thruster," *IEEE Trans. on Plasma Science* **34**:1, Part 1 (April 2006) 132-141; Princeton Plasma Physics Laboratory Report PPPL-4118 (October 2005) 40 pp.

Smirnov, A., Raiteses, Y., and Fisch, N.J., The Effect of Magnetic Field on the Performance of Miniaturized Cylindrical Hall Thrusters, in the *Proceedings of the 29th International Electric Propulsion Conference (IEPC05)*, (31 October - 4 November 2005, Princeton, NJ) IEPC-2005-099.

*Snipes, J.A., Fasoli, A., Gorelenkov, N.N., Parker, R.R., Sears, J.A., and Tang, V., "Moderate Toroidal Mode Number Alfvén Eigenmode Damping Rate Measurements on Alcator C-Mod," in the *Proceedings of the 33rd European Physical Society Conference on Plasma Physics* (19-23 June 2006, Roma, Italy), edited by F. De Marco and G. Vlad, Contributed Papers Vol. **301** (EPS 2006) P-5.130. The conference proceedings is available on CD-ROM. Papers are available in PDF format at <http://eps2006.frascati.enea.it/papers/start.htm> (active as of 2 July 2007).

*§Snipes, J.A., Gorelenkov, N.N., and Sears, J.A., "A Comparison of Measured and Calculated Toroidal Alfvén Eigenmode Damping Rates in Alcator C-Mod," *Nucl. Fusion* **46**:12 (December 2006) 1036-1046.

*Solodov, A.A., Malkin, V.M., and Fisch, N.J., "Limits for Light Intensification by Reflection from Relativistic Plasma Mirrors," *Phys. Plasmas* **13**:9 (September 2006) Article No. 093102 (5 pages).

Solomon, W.M., Burrell, K.H., Andre, R., Baylor, L.R., Budny, R., Gohil, P., Groebner, R.J., Holcomb, C.T., Houlberg, W.A., and Wade, M.R., "Experimental Test of the Neoclassical Theory of Impurity Poloidal Rotation in Tokamaks," *Phys. Plasmas* **13**:5 (May 2006)

Article No. 056116 (12 pages); invited paper at the *47th Annual Meeting of the American Physical Society, Division of Plasma Physics* (24-28 October 2005, Denver, CO).

Son, S. and Fisch, N.J., "Controlled Fusion with Hot-ion Mode in a Degenerate Plasma," *Phys. Lett. A* **356**:1 (24 July 2006) 65-71; Princeton Plasma Physics Laboratory Report PPPL-4133 (December 2005) 20 pp.

Son, S. and Fisch, N.J., "Ignition Regime for Fusion in a Degenerate Plasma," *Phys. Lett. A* **356**:1 (24 July 2006) 72-78; Princeton Plasma Physics Laboratory Report PPPL-4138 (December 2005) 18 pp.

Son, S. and Fisch, N.J., "Current-drive Efficiency in a Degenerate Plasma," *Phys. Rev. Lett.* **95**:22 (25 November 2005) Article No. 225002; Princeton Plasma Physics Laboratory Report PPPL-4130 (December 2005) 4 pp.

*Sontag, A.C., Sabbagh, S.A., Zhu, W., and 10 additional co-authors representing 5 institutions including Menard, J.E., Bell, R.E., Bell, M.G., Gates, D.A., and LeBlanc, B.P. from PPPL, "Investigation of Resistive Wall Mode Stabilization Physics in High Beta Plasmas using applied Non-axisymmetric Fields in NSTX," in the *Proceedings of the 21st Fusion Energy Conference (FEC 2006)*, (16-21 October 2006, Chengdu, People's Republic of China) paper EX/7-2Rb. An unedited conference proceedings (IAEA CN-149) is available in electronic format on CD-ROM and in PDF format on the IAEA Physics Section web site at <http://www.naweb.iaea.org/naweb/physics/FEC/FEC2006/html/index.htm> (active as of 19 July 2007).

*†Soukhanovskii, V., Maingi, R., Bush, E.E., Raman, R., Bell, R.E., Kaita, R., Kugel, H.W., Lasnier, C.J., LeBlanc, B.P., Menard, J.E., Paul, S.F., Roquemore, A.L., and the NSTX Research Team, "Divertor Heat Flux Reduction and Detachment Experiments in NSTX," *J. Nucl. Mater.* **363-365** (15 June 2007) 432-436; *Proceedings of the 17th International Conference on Plasma-surface Interactions* 22-26 May 2006, Hefei, Anhui, China).

*†Soukhanovskii, V.A., Johnson, D.W., Kaita, R., and Roquemore, A.L., "Electron Density Measurements in the National Spherical Torus Experiment Detached Divertor Region using Stark Broadening of Deuterium Infrared Paschen Emission Lines," *Rev. Sci. Instrum.* **77**:10 (October 2006) Article No 10F127 (4 pp); *Proceedings of the 16th Topical Conference on High-Temperature Plasma Diagnostics* (7-11 May 2006, Williamsburg, VA).

*†Soukhanovskii, V.A., Kugel, H.W., Kaita, R., Roquemore, A.L., Bell, M., Blanchard, W., Bush, C., Gernhardt, R., Gettelfinger, G., Gray, T., Majeski, R., Menard, J., Provost, T., Sichta, P., and Raman, R., “Supersonic Gas Injector for Plasma Fueling,” in the *Proceedings of the 21st IEEE/NPSS Symposium on Fusion Engineering 2005* (26-29 September 2005, Knoxville, TN) 4 pp. Available from IEEE on CD-ROM, Digital Object Identifier 10.1109/FUSION.2005.252925 (posted online 4 December 2006).

*Soukhanovskii, V.A., Maingi, R., Raman, R., the NSTX Team, and 10 additional co-authors representing 4 institutions including Bell, R.E., Gates, D., Kaita, R., Kugel, H.W., LeBlanc, B.P., Menard, J.E., Paul, S.F., and Roquemore, A.L. from PPPL, “Divertor Heat Flux Reduction and Detachment in NSTX,” in the *Proceedings of the 21st Fusion Energy Conference (FEC 2006)*, (16-21 October 2006, Chengdu, People’s Republic of China) paper EX/P4-28. An unedited conference proceedings (IAEA CN-149) is available in electronic format on CD-ROM and in PDF format on the IAEA Physics Section web site at <http://www-naweb.iaea.org/napc/physics/FEC/FEC2006/html/index.htm> (active as of 19 July 2007).

Spaleta, J., “Experimental Study of the Effects of Lithium-coated Plasma-facing Components on Energy Confinement Time in the CDX-U Device,” Ph.D. Dissertation, Princeton University (June 2006).

†Spaleta, J., Zakharov, L., Kaita, R., Majeski, R., and Gray, T., “Magnetic Probe Response Function Calibrations for Plasma Equilibrium Reconstructions of CDXU,” *Rev. Sci. Instrum.* **77**:10 (October 2006) Article No 10E305 (3 pp); *Proceedings of the 16th Topical Conference on High-Temperature Plasma Diagnostics* (7-11 May 2006, Williamsburg, VA).

*Spizzo, G., Cappello, S., Cravotta, A., Escande, D.F., Predebon, I., Marrelli, L., Martin, P., and White, R.B., “Transport Barrier inside the Reversal Surface in the Chaotic Regime of the Reversed-field Pinch,” *Phys. Rev. Lett.* **96**:2 (20 January 2006) Article No. 025001.

Startsev, Edward A. and Davidson, Ronald C., “Two-stream Instability for a Longitudinally Compressing Charged Particle Beam,” *Phys. Plasmas* **13**:6 (June 2006) Article No. 062108 (8 pages); Princeton Plasma Physics Laboratory Report PPPL-4170 (June 2006) 24 pp.

†Startsev, E.A. and Davidson, R.C., “Dynamic Stabilization of the Two-Stream Instability during

Longitudinal Compression of Intense Charged Particle Beam Propagation Through Background Plasma,” *Nucl. Instrum. Methods Phys. Res. A: Accelerators, Spectrometers, Detectors and Associated Equipment* **577**:1-2 (1 July 2007) 79-85; *Proceedings of the 16th International Symposium on Heavy Ion Inertial Fusion*, HIF06 (9-14 July 2006, Saint-Malo, France).

Startsev, Edward A., Davidson, Ronald C., and Qin, Hong, “Anisotropy-driven Collective Instability in Intense Charged Particle Beams,” *Phys. Rev. ST Accel. Beams* **8**:12 (December 2005) Article No. 124201 (10 pages).

†Stotler, D.P., “Towards a Revised Monte Carlo Neutral Particle Surface Interaction Model,” *Phys. Scr.* **T124** (May 2006) 23-26; *Workshop on New Directions for Advanced Computer Simulations and Experiments in Fusion-related Plasma-surface Interactions* (21-23 March 2005, Oak Ridge National Laboratory, TN).

Stotler, D.P., Boedo, J., LeBlanc, B., Maqueda, R.J., and Zweben, S.J., “Progress towards the Validation of Models of the Behavior of Neutral Helium in Gas Puff Imaging Experiments,” *J. Nucl. Mater.* **363-365** (15 June 2007) 686-692; *Proceedings of the 17th International Conference on Plasma-surface Interactions* 22-26 May 2006, Hefei, Anhui, China); “Details of Neutral Transport in Gas Puff Imaging Experiments,” Princeton Plasma Physics Laboratory Report PPPL-4182 (June 2006) 14 pp.

†Stratton, B., Brooks, A., Brown, T., Johnson, D., Labik, G., Lazarus, E., Pomphrey, N., Raftopoulos, S., and Zarnstorff, M., “External Magnetic Diagnostics for the National Compact Stellarator Experiment,” *Rev. Sci. Instrum.* **77**:10 (October 2006) Article No 10E314 (3 pp); *Proceedings of the 16th Topical Conference on High-Temperature Plasma Diagnostics* (7-11 May 2006, Williamsburg, VA). Princeton Plasma Physics Laboratory Report PPPL-4177 (June 2006) 12 pp.

*Strauss, H.R., Sugiyama, L., Chang, C.S., Park, G.Y., Ku, S., Park, W., Breslau, J., and Jardin, S., “ELM Simulations with M3D,” in the *Proceedings of the 21st Fusion Energy Conference (FEC 2006)*, (16-21 October 2006, Chengdu, People’s Republic of China) paper TH/P8-6. An unedited conference proceedings (IAEA CN-149) is available in electronic format on CD-ROM and in PDF format on the IAEA Physics Section web site at <http://www-naweb.iaea.org/napc/physics/FEC/FEC2006/html/index.htm> (active as of 19 July 2007).

*Stutman, D., Finkenthal, M., Tritz, K. and 16 additional co-authors including Redi, M.H., Kaye, S.M., Bell, M.G., Bell, R.E., LeBlanc, B.P., Hill, K.W., Medley, S.S., Menard, J.E., Rewoldt, G., and Wang, W. from PPPL, “Studies of Improved Electron Confinement in Low Density L-mode National Spherical Torus Experiment Discharges,” *Phys. Plasmas* **13**:9 (September 2006) Article No. 092511 (11 pages).

*Stutman, D., Tritz, K., Delgado, L., Finkenthal, M., Bell, M., Bell, R., Bush, C., Kaye, S., Kugel, H., LeBlanc, B., Maingi, R., and Soukhanovskii, V., “Perturbative Studies of Electron Transport in NSTX H-modes,” in the *Proceedings of the 33rd European Physical Society Conference on Plasma Physics* (19-23 June 2006, Roma, Italy), edited by F. De Marco and G. Vlad, Contributed Papers Vol. **301** (EPS 2006) P-5.120. The conference proceedings is available on CD-ROM. Papers are available in PDF format at <http://eps2006.frascati.enea.it/papers/start.htm> (active as of 2 July 2007).

*†Stutman, D., Tritz, K., Delgado-Aparicio, L., Finkenthal, M., Suliman, G., Roquemore, L., Kaita, R., Kugel, H., Johnson, D., Tamura, N., Sato, K., and Sudo, S., “High Throughput Measurements of Soft X-ray Impurity Emission Using a Multilayer Mirror Telescope,” *Rev. Sci. Instrum* **77**:10 (October 2006) Article No 10F330 (5 pp); *Proceedings of the 16th Topical Conference on High-Temperature Plasma Diagnostics* (7-11 May 2006, Williamsburg, VA).

*Sun, X., Cohen, S.A., Scime, Earl E., and Miah, Mahmood M., “On-axis Parallel Ion Speeds near Mechanical and Magnetic Apertures in a Helicon Plasma Device,” *Phys. Plasmas* **12**:10 (October 2005) Article No. 103509 (8 pages); Princeton Plasma Physics Laboratory Report PPPL-4144 (January 2006) 32 pp.

*Sydorenko, D., Smolyakov, A., Kaganovich, I., and Raitses, Y., “Electron Velocity Distribution in Bounded Plasmas by Secondary Electron Emission,” *IEEE Trans. Plasma Sci.* **34**:3, Part 2 (June 2006) 815–824; presented at the *Workshop on Nonlocal, Collisionless Electron Transport in Plasmas* (2-4 August 2005, Princeton, NJ). Princeton Plasma Physics Laboratory Report (PPPL-4151 (February 2006)10 pp.

*Sydorenko, D., Smolyakov, A., Kaganovich, I., and Raitses, Y., “Kinetic Simulations of Secondary Electron Emission Effects in Hall thrusters,” *Phys. Plasmas* **13**:1 (January 2006) Article No. 014501 (4 pages).

*Tam, D., Radovitzky, R., and Samtaney, R., “An Algorithm for Modeling the Interaction of a Flexible Rod with a Two-dimensional High-speed Flow,” *Int. J. Numer. Methods Eng.* **64**:8 (28 October 2005) 1057-1077.

Taylor, G., Bigelow, T.S., Caughman, J.B., Carter, M.D., Diem, S., Efthimion, P.C., Ellis, R.A., Ershov, N.M., Fredd, E., Harvey, R.W., Hosea, J., Jaeger, F., LeBlanc, B., Phillips, C.K., Preinhaelter, J., Ram, A.K., Rasmussen, D.A., Smirnov, A.P., Urban, J., Wilgen, J.B., and Wilson, J.R., “Electron Bernstein Wave Research on Overdense Plasmas in the National Spherical Torus Experiment,” Princeton Plasma Physics Laboratory Report PPPL-4175 (June 2006) 6 pp; to be published in the *Proceedings of the Fourteenth Joint Workshop on Electron Cyclotron Emission and Electron Cyclotron Heating (EC14)* (9-12 May 2006, Santorini Island, Greece) ID No. 6.

*†Terry, J.L., Basse, N.P., Cziegler, I., Greenwald, M., Grulke, O., LaBombard, B., Zweben, S.J., Edlund, E.M., Hughes, J.W., Lin, L., Lin, Y., Porkolab, M., Sampsell, M., Veto, B., and Wukitch, S.J., “Transport Phenomena in the Edge of Alcator C-Mod Plasmas,” *Nucl. Fusion* **45**:11 (November 2005) 1321-1327.

*†Terry, D.R., Parker, R., Liptac, J., and 15 additional co-authors including Bernabei, S., Greenough, N., and Wilson, J.R. from PPPL, “Commissioning of the Lower Hybrid Current Drive System on Alcator C-Mod,” in the *Proceedings of the 21st IEEE/NPSS Symposium on Fusion Engineering 2005* (26-29 September 2005, Knoxville, TN) 4 pp. Available from IEEE on CD-ROM, Digital Object Identifier 10.1109/FUSION.2005.252948 (posted online 4 December 2006).

*†Tsai, C.C., Freudenberg, K., Nelson, B.E., Rasmussen, B.E., “Dynamic Strain and Temperature Instrument for NCSX Coil Development,” in the *Proceedings of the 21st IEEE/NPSS Symposium on Fusion Engineering 2005* (26-29 September 2005, Knoxville, TN) 3 pp. Available from IEEE on CD-ROM, Digital Object Identifier 10.1109/FUSION.2005.252892 (posted online 4 December 2006).

*Tuccillo, A.A., Barbato, E., Bae, Y.S., and 37 co-authors from 10 institutions including Bernabei, S. from PPPL, “Progress in LHCD: A Tool for Advanced Regimes on ITER,” Special Issue *Plasma Phys. Control. Fusion* **47**:12B (December 2005) B363-B377; invited paper at the *32nd European Physical Society Conference on Plasma Physics* (27 June-1 July 2005, Tarragona, Spain).

*Uhm, H.S. and Davidson, R.C., “Low-frequency Flute Instabilities of Self-pinch Ion Beams,” *Phys. Plasmas* **12**:12 (December 2005) Article No. 123105 (8 pages).

*Uzdensky, D.A. and Kulsrud, R.M., “Physical Origin of the Quadrupole Out-of-plane Magnetic Field in Hall-MHD Reconnection,” *Phys. Plasmas* **13**:6 (June 2006) Article No. 062305 (14 pages); Princeton Plasma Physics Laboratory Report PPPL-4145 (January 2006) 44 pp.

*†Van Zeeland, M.A., Austin, M.E., Carlstrom, T.N., Deterly, T., Finkenthal, D.K., Holcomb, C.T., Jayakumar, R.J., Kramer, G.J., Makowski, M.A., McKee, G.R., Nazikian, R., Peebles, W.A., Rhodes, T.L., Solomon, W.M., and Strait, E.J., “Internal Alfvén Eigenmode Observations on DIII-D,” *Nucl. Fusion* **46**:10 (October 2006) S880-S887; presented at *9th IAEA Technical Meeting on Energetic Particles in Magnetic Confinement Systems* (9-11 November 2005, Takayama, Japan).

*Van Zeeland, M.A., Kramer, G.J., Austin, M.E., Boivin, R.L., Heidbrink, W.W., Makowski, M.A., McKee, G.R., Nazikian, R., Solomon, W.M., and Wang, G., “Radial Structure of Alfvén Eigenmodes in the DIII-D Tokamak through Electron-cyclotron-emission Measurements,” *Phys. Rev. Lett.* **97**:13 (29 September 2006) Article No. 135001.

†Viola, M.E., Brown, T., Heitzenroeder, P., Malinowski, F., Reiersen, W., Sutton, L., Goranson, P., Nelson, B., Cole, M., Manuel, M., and McCorkle, D., “NCSX Vacuum Vessel Fabrication,” in the *Proceedings of the 21st IEEE/NPSS Symposium on Fusion Engineering 2005* (26-29 September 2005, Knoxville, TN) 4 pp. Available from IEEE on CD-ROM, Digital Object Identifier 10.1109/FUSION.2005.252910 (posted online 4 December 2006); Princeton Plasma Physics Laboratory Report PPPL-4114 (October 2005) 4 pp.

*Voinier C., Skinner C.H., and Roquemore, A.L., “Electrostatic Dust Detection on Remote Surfaces,” *J. Nucl. Mater.* **346**:2-3 (November 2005) 266-271.

*Voitsekhovitch, I., Budny, R.V., Joffrin, E., Leggate, H., McDonald, D.C., and the JET EFDA Contributors, “Energy, Particle and Momentum Transport in JET H-mode Plasmas and Hybrid Scenarios,” in the *Proceedings of the 33rd European Physical Society Conference on Plasma Physics* (19–23 June 2006, Roma, Italy), edited by F. De Marco and G. Vlad, Contributed Papers Vol. **301** (EPS 2006) P-1.078. The conference proceedings is

available on CD-ROM. Papers are available in PDF format at <http://eps2006.frascati.enea.it/papers/start.htm> (active as of 2 July 2007).

*Voitsekhovitch, I., Zastrow, K.D., Alper, B., Bonheure, G., Garbet, X., Kiptily, V., de la Luna, E., McCune, D., McDonald, D.C., Popovichev, S., Sharapov, S.E., Stork, D., and JET EFDA Contributors, “Effect of Sawtooth Activity on Tritium and Beam Deuterium Evolution in Trace Tritium Experiments on JET,” *Plasma Phys. Control. Fusion* **47**:11 (November 2005) 1877-1893.

*†Wang, G., Peebles, W.A., Doyle, E.J., Rhode, T.L., Zeng, L., Nguyen, X., Osborne, T.H., Snyder, P.B., Kramer, G.J., Nazikian, R., Groebner, R.J., Burrell, K.H., Leonard, A.W., Fenstermacher, M.E., and Strait, E.J., “Initial Results of H-mode Edge Pedestal Turbulence Evolution with Quadrature Reflectometer Measurements on DIII-D,” *J. Nucl. Mater.* **363-365** (15 June 2007) 534-538; *Proceedings of the 17th International Conference on Plasma-surface Interactions 22-26 May 2006*, Hefei, Anhui, China).

*Wang, G., Peebles, W.A., Rhodes, T.L., Kramer, G.J., Doyle, E.J., McKee, G.R., Nazikian, R., Crocker, N.A., Nguyen, X., Zeng, L., Kubota, S., and Van Zeeland, M.A., “Quantitative Density Fluctuation Measurements Utilizing Quadrature Reflectometers on DIII-D,” *Nucl. Fusion* **46**:9 (September 2006) S708-S713; Special Issue on Reflectometry.

Wang, W.X., Lin, Z., Tang, W.M., Lee, W.W., Ethier, S., Lewandowski, J.L.V., Rewoldt, G., Hahm, T.S., and Manickam, J., “Gyrokinetic Simulation of Global Turbulent Transport Properties in Tokamak Experiments,” *Phys. Plasmas* **13**:9 (September 2006) Article No. 092505 (12 pages); Princeton Plasma Physics Laboratory Report PPPL-4142 (January 2006) 30 pp.

Wang, W.X., Rewoldt, G., Tang, W.M., Hinton, F.L., Manickam, J., Zakharov, L.E., White, R.B., and Kaye, S., “Nonlocal Neoclassical Transport in Tokamak and Spherical Torus Experiments,” *Phys. Plasmas* **13**:8 (August 2006) Article No. 082501 (15 pages); Princeton Plasma Physics Laboratory Report 4156 (March 2006) 38 pp.

*†Welch, Dale R.; Rose, David V.; Thoma, Carsten; Sefkow, Adam B.; Kaganovich, Igor D.; Seidl, Peter A.; Yu, Simon S.; Barnard, John J.; and Roy, Prabir K., “Integrated Simulation of an Ion-driven Warm Dense Matter Experiment,” *Nucl. Instrum. Methods Phys.*

Res. A: Accelerators, Spectrometers, Detectors and Associated Equipment **577**:1-2 (1 July 2007) 231-237; *Proceedings of the 16th International Symposium on Heavy Ion Inertial Fusion*, HIF06 (9-14 July 2006, Saint-Malo, France).

*Weller, A., Sakakibara, K.Y., Watanabe, K., Toi, K., Geiger, J., Zarnstorff, M.C., Hudson, S.R., Reiman, A., Werner, C., Nührenberg, C., Ohdachi, S., Suzuki, Y., Yamada, H., the W7-AS Team, and the LHD Team, "Significance of MHD Effects in Stellarator Confinement," *Fus. Sci. Techn.* **50**:2 (August 2006) Guest Editors Enrique Ascasibar and Hiroshi Yamada, pages 158-170; selected papers from the *Fifteenth International Stellarator Workshop* (3-7 October 2005, Madrid, Spain).

*Wesley, J.C., Hyatt, A.W., Strait, E.J., and 15 additional co-authors representing 8 institutions including Fredrickson, E., Gates, D.A., and Menard J. from PPPL, "Disruption Characterization and Database Activities for ITER," in the *Proceedings of the 21st Fusion Energy Conference (FEC 2006)*, (16-21 October 2006, Chengdu, People's Republic of China) paper IT/P1-21. An unedited conference proceedings (IAEA CN-149) is available in electronic format on CD-ROM and in PDF format on the IAEA Physics Section web site at <http://www-naweb.iaea.org/napc/physics/FEC/FEC2006/html/index.htm> (active as of 19 July 2007).

*White, A.E., Zweben, S.J., Burin, M.J., Carter, T.A., Hahm, T.S., Krommes, J.A., and Maqueda, R.J., "Bispectral Analysis of Low- to High-confinement Mode Transitions in the National Spherical Torus Experiment," *Phys. Plasmas* **13**:7 (July 2006) Article No. 072301 (14 pages); Princeton Plasma Physics Laboratory Report PPPL-4178 (June 2006) 36 pp.

*†Wilgen, J.B., Ryan, P.M., Hanson, G.R., Swain, D.E., Bernabei, S.I., Greenough, N., DePasquale, S., Phillips, C.K., Hosea, J.C., and Wilson, J.R., "Reflectometer Sensing of rf Waves in Front of the High Harmonic Fast Wave Antenna on NSTX," *Rev. Sci. Instrum* **77**:10 (October 2006) Article No 10E933 (4 pp); *Proceedings of the 16th Topical Conference on High-Temperature Plasma Diagnostics* (7-11 May 2006, Williamsburg, VA).

*Williamson, D., Brooks, A., Brown, T., Chrzanowski, J., Cole, M., Fan, H.-M., Freudenberg, K., Fogarty, P., Hargrove, T., Heitzenroeder, P., Lovett, G., Miller, P., Myatt, R., Nelson, B., Reiersen, W., and Strickler, D., "Modular Coil Design Developments for the National Compact Stellarator Experiment (NCSX)," *Fusion Eng.*

Des. **75-79** (November 2005) 71-74; *Proceedings of the 23rd Symposium of Fusion Technology* (20-24 September 2004, Venice, Italy) edited by F. Gnesotto, R. Piovan, and Basso.

†*Williamson, D., Brooks, A., Brown, T., Chrzanowski, J., Cole, M., Fan, H.-M., Freudenberg, K., Fogarty, P., Hargrove, T., Heitzenroeder, P., Lovett, G., Nelson, B., Raftopolous, S., Reiersen, W., Stratton, B., and Strickler, D., "Challenges in Designing the Modular Coils for the National Compact Stellarator Experiment (NCSX)," in the *Proceedings of the 21st IEEE/NPSS Symposium on Fusion Engineering 2005* (26-29 September 2005, Knoxville, TN) 4 pp. Available from IEEE on CD-ROM, Digital Object Identifier 10.1109/FUSION.2005.252889 (posted online 4 December 2006).

*§Wing, S., Johnson, J.R., and Fujimoto, M., "The Time-scale for the formation of the Cold-dense Plasma Sheet: A Case Study," *Geophys. Res. Lett.* **33**:23 (9 December 2006) Article No. L23106.

†Woolley, R., "Analysis of NSTX TF Joint Voltage Measurements," in the *Proceedings of the 21st IEEE/NPSS Symposium on Fusion Engineering 2005* (26-29 September 2005, Knoxville, TN) 6 pp. Available from IEEE on CD-ROM, Digital Object Identifier 10.1109/FUSION.2005.252877 (posted online 4 December 2006); Princeton Plasma Physics Laboratory Report PPPL-4116 (October 2005) 6 pp.

*†Wright, J.C., Berry, L.A., Bonoli, P.T., Batchelor, D.B., Jaeger, E.F., Carter, M.D., D'Azevedo, E., Phillips, C.K., Okuda, H., Harvey, R.W., Smithe, D.N., Myra, J.R., D'Ippolito, D.A., Brambilla, M., and Dumont, R.J., "Nonthermal Particle and Full-wave Diffraction Effects on Heating and Current Drive in the ICRF and LHRF Regimes," *Nucl. Fusion* **45**:11 (November 2005) 1411-1418.

*Xu, X.Q., Bodi, K., Candy, J., and 13 additional co-authors representing 5 institutions including Qin, H. from PPPL, "Edge Gyrokinetic Theory and Continuum Simulations," in the *Proceedings of the 21st Fusion Energy Conference (FEC 2006)*, (16-21 October 2006, Chengdu, People's Republic of China) paper TH/P6-23. An unedited conference proceedings (IAEA CN-149) is available in electronic format on CD-ROM and in PDF format on the IAEA Physics Section web site at <http://www-naweb.iaea.org/napc/physics/FEC/FEC2006/html/index.htm> (active as of 19 July 2007).

*Yagi, M., Ueda, T., Itoh, S. I., Azumi, M., Itoh, K., Diamond, P.H., and Hahm T.S., “Turbulence Spreading in Reversed Shear Plasmas,” *Special Issue Plasma Phys. Control. Fusion* **48**:5A (May 2006) A409–A418; papers from the *10th IAEA Technical Meeting on H-mode Physics and Transport Barriers* (28-30 September 2005, St. Petersburg, Russia).

*Yakovenko, Y.V., Kolesnichenko, Ya.I., Lubsenko, V.V., Burdo, O.S., and White, R.B., “Redistribution of Energetic Ions during Reconnection Events in NSTX,” in the *Proceedings of the 21st Fusion Energy Conference (FEC 2006)*, (16-21 October 2006, Chengdu, People’s Republic of China) paper TH/P6-6. An unedited conference proceedings (IAEA CN-149) is available in electronic format on CD-ROM and in PDF format on the IAEA Physics Section web site at <http://www-naweb.iaea.org/napc/physics/FEC/FEC2006/html/index.htm> (active as of 19 July 2007).

Yamada, M., Ji, H., Belova, E., Gerhardt, S.P., Davidson, R.C., and Mikkelsen, D., “A Self-organized Plasma with Induction, Reconnection, and Injection Techniques: the SPIRIT concept for Field Reversed Configuration Research,” submitted to *Plasma and Fusion Research in Japanese Society of Plasma Fusion* (2006).

Yamada, Masaaki; Ren, Yang; Ji, Hantao; Breslau, Joshua; Gerhardt, Stephan; Kulsrud, Russell; and Kuritsyn, Aleksey, “Experimental Study of Two-fluid Effects on Magnetic Reconnection in Laboratory Plasma with Variable Collisionality,” *Phys. Plasmas*. **13**:5 (May 2006) Article No. 052119 (13 pages); Princeton Plasma Physics Laboratory Report 4171 (June 2006) 24 pp.

*Yan, Longwen; Evans, T.E.; Kaye, S.M.; Maingi, R.; “Modeling of Stochastic Magnetic Perturbation by RWMEF coils on NSTX,” *Nuclear Fusion* **46**:10 (October 2006) 858-863.

*Yu, S.S., Logan, B.G., Barnard, J.J., and 27 additional co-authors representing 7 institutions including Davidson, R.C., Gilson, E.P., Grisham, L.R., Kaganovich, I.D., Qin, H., Sefkow, A., and Startsev, E.A. from PPPL, “Heavy-ion-fusion-science: Summary of U.S. Progress,” in the *Proceedings of the 21st Fusion Energy Conference (FEC 2006)*, (16-21 October 2006, Chengdu, People’s Republic of China) paper IF/P5-11. An unedited conference proceedings (IAEA CN-149) is available in electronic format on CD-ROM and in PDF

format on the IAEA Physics Section web site at <http://www-naweb.iaea.org/napc/physics/FEC/FEC2006/html/index.htm> (active as of 19 July 2007).

Zakharov, L.E., Blanchard, W., Kaita, R., Kugel, H., Majeski, R., and Timerlake, J., “Low Recycling Regime in ITER and the LiWall Concept for its Divertor,” *J. Nucl. Mater.* **363-365** (15 June 2007) 453-457; *Proceedings of the 17th International Conference on Plasma-surface Interactions 22-26 May 2006*, Hefei, Anhui, China).

Zarnstorff, M.C., Pomphrey, N., and Brooks, A., “Magnetic Alignment of NCSX and Control of Field Errors Authors,” in the *Proceedings of the 33rd European Physical Society Conference on Plasma Physics* (19-23 June 2006, Roma, Italy), edited by F. De Marco and G. Vlad, *Contributed Papers Vol. 301* (EPS 2006) P-5.121. The conference proceedings is available on CD-ROM. Papers are available in PDF format at <http://eps2006.frascati.enea.it/papers/start.htm> (active as of 2 July 2007); Princeton Plasma Physics Laboratory Report PPPL-4179 (June 2006) 4 pp.

*Zhu, W., Sabbagh, S.A., Bell, R.E., Bialek, J.M., Bell, M.G., LeBlanc, B.P., Kaye, S.M., Levinton, F.M., Menard, J.E., Shaing, K.C., Sontag, A.C., and Yuh, H., “Observation of Plasma Toroidal Momentum Dissipation by Neoclassical Toroidal Viscosity,” *Phys. Rev. Lett.* **96**:22 (9 June 2006) Article No. 225002.

*Zonca, F., Briguglio, S., Chen, L., Fogaccia, G., Hahm, T.S., Milaranov, A.V., and Vlad, G., “Physics of Burning Plasmas in Toroidal Magnetic Confinement Devices,” *Special Issue Plasma Phys. Control. Fusion* **48**:12B (December 2006) B15-B28; Invited paper at the *33rd European Physical Society Conference on Plasma Physics* (19-23 June 2006, Roma, Italy).

Zweben, S.J., Maqueda, R.J., Terry, J.L., Munsat, T., Myra, J.R., D’Ippolito, D., Russell, D.A., Krommes, J.A., LeBlanc, B., Stoltzfus-Dueck, T., Stotler, D.P., Williams, K.M., Bush, C.E., Maingi, R., Gruike, O., Sabbagh, S.A., and White, A.E., “Structure and Motion of Edge Turbulence in the National Spherical Torus Experiment and Alcator C-mod,” *Phys. Plasmas* **13**:5 (May 2006) Article No. 056114 (8 pages); Invited paper at the *47th Annual Meeting of the American Physical Society, Division of Plasma Physics* (24-28 October 2005, Denver, CO). Princeton Plasma Physics Laboratory Report PPPL-4154 February 2006) 28 pp.

Abbreviations, Acronyms, and Symbols

1-D	One-dimensional
2-D	Two-dimensional
3-D	Three-dimensional
AAPT	American Association of Physics Teachers
APDEC	Applied Partial Differential Equations Center part of the DOE Scientific Discovery through Advanced Computing (SciDac) program.
AFOSR	(U.S.) Air Force Office of Scientific Research
Alcator C-Mod	A tokamak at the Plasma Science and Fusion Center at the Massachusetts Institute of Technology
ALPS	(Energy) Advanced Liquid Plasma-facing Surface Program (a U.S. Department of Energy Program)
AMP	Adaptive Mesh Refinement
AMR	Adaptive Mesh Refinement
AMTEX	American Textile Partnership
APEX	Advanced Power Extraction Program (a U.S. Department of Energy Program)
ARIES	Advanced Reactor Innovation Evaluation Studies
ARL	Army Research Laboratory
ARSC	Arctic Region Supercomputing Center
AS	Advanced Stellarator
ASDEX	Axially Symmetric Divertor Experiment (at the Max-Planck-Institut für Plasmaphysik, Garching, Germany)
ASDEX-U	ASDEX-Upgrade (went into operation in 1990)
AT	Advanced Tokamak
B_t	Toroidal Magnetic Field
BAE	Beam Alfvén Eigenmode
BES	Beam Emission Spectroscopy
BEST	Beam Equilibrium Stability and Transport Code
BPAC	Burning Plasma Assessment Committee (under the National Research Council)
BPX	Burning Plasma Experiment
CAD	Computer-aided Design
CADD	Computer-aided Design and Drafting
CAE	Compressional Alfvén Eigenmode
CAIP	Center for Advanced Information Processing at Rutgers University, New Jersey
CCD	Charge-coupled Device
CD	Current Drive
CD-4	Critical Decision 4
CDR	Conceptual Design Review
CDX-U	Current Drive Experiment-Upgrade at the Princeton Plasma Physics Laboratory now the Lithium Tokamak Experiment
CEMM	Center for Extended MHD Modeling

CER	Charge-exchange Recombination system on DIII-D at General Atomics in California
CFC	Carbon Fiber Composite
CHE	Coaxial Helicity Ejection
CHERS	Charge-exchange Recombination Spectrometer
CHI	Coaxial Helicity Injection
CIEMAT	Centro de Investigaciones Energéticas, Medioambientales y Tecnológicas in Spain
CIT	Compact Ignition Tokamak
cm	Centimeter
C-Mod	A tokamak in the “Alcator” family at the Plasma Science and Fusion Center at the Massachusetts Institute of Technology
CME	Coronal Mass Ejection
CPES	Center for Plasma Edge Simulation
CPPG	Computational Plasma Physics Group at the Princeton Plasma Physics Laboratory
CRADAs	Cooperative Research and Development Agreements
CSWIM	Center for the Simulation of RF Wave Interactions with Magnetohydrodynamics
CTF	Component Test Facility
CY	Calendar Year
DIII-D	A tokamak at the DIII-D National Fusion Facility at General Atomics in San Diego, California
D-D	Deuterium-deuterium
D-T	Deuterium-tritium
D&D	Decontamination and Decommissioning
DARPA	Defense Advanced Research Projects Agency
DART	Days Away, Restricted, Transferred (case rates)
DBM	Drift Ballooning Model
DE	Differential Evolution
DMSP	Defense Meteorological Satellites Program
DND	Double-null Divertor
DOE	(United States) Department of Energy
DWC	Diamond Wire Cutting
EAEs	Ellipticity-induced Alfvén Eigenmodes
EBE	Electron-Bernstein (Wave) Emission
EBW	Electron-Bernstein Wave (Heating)
ECCD	Electron Cyclotron Current Drive
ECE	Electron Cyclotron Emission
ECEI	Electron Cyclotron Emission Imaging (Radiometer)
ECH	Electron Cyclotron Heating
ECR	Electron Cyclotron Resonance
ECRH	Electron Cyclotron Resonance Heating
EDA	Enhanced D_{α} Mode
ER	Error Field
EFC	Error Field Correction
EFDA	European Fusion Development Agreement
EFIT	An equilibrium code
EIO	Energy Industries of Ohio, Inc. of Independence, OH. Subcontractor to manufacture the National Compact Stellarator Experiment modular coil winding forms.
E-LHDI	Electrostatic Lower-hybrid Drift Instability
ELMs	Edge Localized Modes
ELVS	Graphics Program
EMS	Environmental Management System at PPPL
EPM	Energetic Particle Mode

ER	Expansion Region
ER/WM	Environmental Restoration and Waste Management
ERD	Edge Rotation Diagnostic
ERP	Enterprise Resource Planning
ES&H	Environment, Safety, and Health
ES&H/IS	Environment, Safety, and Health and Infrastructure Support Department at PPPL
ESC	Earth Simulator Center in Japan
ESC	Equilibrium and Stability Code
ESnet	Energy Science Network
ET	Experimental Task
ETI	Everson Tesla Incorporated of Nazareth, PA. Subcontractor to manufacture the National Compact Stellarator Experiment toroidal-field coils.
ETG	Electron-temperature Gradient Mode
EU	European Union
eV	Electron Volt
FAC	Field-aligned Current
FCC	Fusion Computational Center
FCPC	Field Coil Power Conversion
FDT	Fluctuation-dissipation Theory
FEAT	Fusion Energy Advanced Tokamak
FEM	Finite Element Method
FES	Fusion Energy Sciences
FESAC	Fusion Energy Sciences Advisory Committee
FIR	Far-infrared
FIRE	Fusion Ignition Research Experiment (a national design study collaboration)
FIReTIP	Far-infrared Tangential Interferometer and Polarimeter
FISMA	Federal Information Security Management Act
FLC	Federal Laboratory Consortium (for Technology Transfer)
FLR	Field-line Resonance
FPT	Fusion Physics and Technology, Inc.
FRC	Field-reversed Configuration
FREP	Fast Reciprocating Edge Probe
FTP	File Transfer Protocol
FUV	Full Ultraviolet
FW	Fast Wave
FWR	Full Wave Reflectometer
FY	Fiscal Year
GA	General Atomics in San Diego, California
GAE	Global Alfvén Eigenmodes
GAM	Geodesic Acoustic Modes
GDC	Glow Discharge Cleaning
GEM	Gas Electronic Multiplier
GFDL	Gas Fluid Dynamics Laboratory (on Princeton University's James Forrestal Campus)
GPI	Gas Puff Imaging
GPSC	Gyrokinetic Particle Simulation Center
GTC	Gyrokinetic Toroidal Code
H-mode	High-confinement Mode
HAPL	High-average Power Laser (Program), hosted by the Naval Research Laboratory
HCX	High Current Experiments at the Lawrence Berkeley National Laboratory
HFS	High-field Side

HHFW	High-harmonic Fast-waves
HIT-II	Helicity Injected Torus II at the University of Washington, Seattle, Washington
HRMIS	Human Resources Management Information System
HTX	Hall Thruster Experiment at the Princeton Plasma Physics Laboratory
HXR	Hard X-Ray
HYM	Hybrid and MHD Code
I-coil	Radial Field Coil
I_p	Plasma Current
I/O	Input/Output
IBW	Ion-Bernstein Wave
IBX	Integrated Beam Experiment
ICE	Ion Cyclotron Emission
ICF	Inertial Confinement Fusion
ICRF	Ion Cyclotron Range of Frequencies
ICW	Ion-cyclotron wave
IDSP	Ion Dynamic Spectroscopy Probe; an optical probe used to measure local ion temperature and flows during magnetic reconnection
IFE	Inertial Fusion Energy
IGNITOR	Ignited Torus
IMF	Interplanetary Magnetic Field
IPP	Institut für Plasmaphysik, Garching, Germany
IPR	Institute for Plasma Research, Gujarat, India
IR	Infrared
IRE	Integrated Research Experiment at the Princeton Plasma Physics Laboratory
IRE	Internal Reconnection Event
ISS	International Stellarator Scaling
ITB	Internal Transport Barrier
ITER	“The Way” in Latin. Formerly interpreted to stand for International Thermonuclear Experimental Reactor, although this usage has been discontinued.
ITG	Ion-temperature Gradient (Mode)
ITPA	International Tokamak Physics Activity
JAERI	Japan Atomic Energy Research Institute
JET	Joint European Torus (JET Joint Undertaking) in the United Kingdom
JET-EP	Joint European Torus Enhancement Program
JFT-2M	A small Japanese tokamak
JHA	Job Hazard Analysis (procedure at PPPL)
JHU	Johns Hopkins University
JT-60U	Japanese Tokamak at the Japan Atomic Energy Research Institute
kA	Kiloampere
KAM	Kolmogorov-Arnold-Moser
KAWs	Kinetic Alfvén Waves
keV	Kiloelectron Volt
kG	Kilogauss
KMB	Kinetic Ballooning Mode
KSTAR	Korea Superconducting Tokamak Advanced Research device being built in Taejon, South Korea
kV	Kilovolt
kW	Kilowatt
L-mode	Low-confinement Mode
LBNL	Lawrence Berkeley National Laboratory

LDV	Laser Doppler Velocimetry
LFS	Low-field Side
LH	Lower-hybrid
LHCD	Lower-hybrid Current Drive
LHD	Large Helical Device; a stellarator operating in Japan
LHDI	Lower-hybrid Drift Instability
LIF	Laser-induced Fluorescence
LITER-1	Lithium evaporator on NSTX (L ithium E vaporato R)
LLNL	Lawrence Livermore National Laboratory
LMX	Liquid Metal Experiment at the Princeton Plasma Physics Laboratory
LPDA	Laboratory Program Development Activities at the Princeton Plasma Physics Laboratory
LPI	Lithium Pellet Injector
LSN	Lower Single Null
LTOA	Long Torus Opening Activity (on the DIII-D at General Atomics)
LTX	Liquid Tokamak Experiment (formerly the CDX-U) at the Princeton Plasma Physics Laboratory
MA	Megampere
MARFEs	Multi-faceted Axisymmetric Radiation From the Edge
MAST	Mega-Ampere Spherical Tokamak at the Culham Laboratory, United Kingdom
MAV	Micro-air Vehicle
MCWF	Modular Coil Winding Form
MFE	Magnetic Fusion Energy
MHD	Magnetohydrodynamic
MHz	Megahertz
MINDS	Miniature Integrated Nuclear Detector System
MIR	Microwave Imaging Reflectometer
MIT	Massachusetts Institute of Technology in Cambridge, Massachusetts
MLM	Multilayer Mirror
MNX	Magnetic Nozzle Experiment at the Princeton Plasma Physics Laboratory
MPI	Message Passing Interface
MPP	Massively Parallel Processor
MPTS	Multi-point Thomson Scattering
MRI	Magnetorotational Instability Experiment at the Princeton Plasma Physics Laboratory
MRX	Magnetic Reconnection Experiment at the Princeton Plasma Physics Laboratory
ms, msec	Millisecond
MSE	Motional Stark Effect (Diagnostic)
MST	Madison Symmetric Torus at the University of Wisconsin at Madison
MW	Megawatt
NASA	National Aeronautics and Space Administration
NBCD	Neutral-beam Current Drive
NBI	Neutral Beam Injection (Heating)
NCCS	National Center for Computational Sciences at the Oak Ridge National Laboratory
NCSX	National Compact Stellarator Experiment (a Princeton Plasma Physics Laboratory-Oak Ridge National Laboratory fabrication project)
NDCX	Neutralized Drift Compression Experiment at the Lawrence Berkeley National Laboratory
NEPA	National Energy Policy Act
NERSC	National Energy Research Supercomputer Center
NIFS	National Institute of Fusion Science (Japan)
NIFS	National Institute of Standards and Technology
NJIT	New Jersey Institute of Technology
NJTC	New Jersey Technology Council

NNBI	Negative-ion-based Neutral-beam Injection
NPA	Neutral Particle Analyzer
NRC	National Research Council
NRC	Nuclear Regulatory Commission
NRL	Naval Research Laboratory
NSF	National Science Foundation
NSO	Next-step Option
NSO-PAC	Next-step Option Program Advisory Committee
NSST	Next-step Spherical Torus
NSTX	National Spherical Torus Experiment at the Princeton Plasma Physics Laboratory
NTCC	National Transport Code Collaboration
NTM	Neoclassical Tearing Mode
NTX	Neutralized Transport Experiment at the Lawrence Berkeley National Laboratory
NUF	(DOE) National Undergraduate Fellowship
OFES	Office of Fusion Energy Sciences (at the U.S. Department of Energy)
OH	Ohmic Heating
ORNL	Oak Ridge National Laboratory, Oak Ridge, Tennessee
ORPA	Office of Research and Project Administration at Princeton University
OS	Optimized Shear
OSHA	Occupational Safety and Health Administration
PAC	Program Advisory Committee
PBX	Princeton Beta Experiment, predecessor to PBX-M at the Princeton Plasma Physics Laboratory (no longer operating)
PBX-M	Princeton Beta Experiment-Modification at the Princeton Plasma Physics Laboratory (no longer operating)
PDC	Pulse Discharge Cleaning
PDI	Parametric Decay Instabilities
PDR	Preliminary Design Report
PDR	Preliminary Design Review
PDX	Poloidal Divertor Experiment, predecessor to PBX and PBX-M at the Princeton Plasma Physics Laboratory (no longer operating)
PEGASUS	A toroidal experiment at the University of Wisconsin at Madison.
PF	Poloidal Field
PFC	Plasma-facing Component
PFRC	Princeton Field-reversed Configuration (Experiment) at the Princeton Plasma Physics Laboratory
PIC	Particle-in-Cell
PICSciE	Princeton Institute for Computational Science and Engineering
PLT	Princeton Large Torus at the Princeton Plasma Physics Laboratory (no longer operating)
PPPL	Princeton Plasma Physics Laboratory (Princeton University, Princeton, New Jersey)
PPST	Program in Plasma Science and Technology
PSACI	Plasma Science Advanced Scientific Computing Initiative
PSEL	Plasma Science Education Laboratory at the Princeton Plasma Physics Laboratory
PSFC	Plasma Science and Fusion Center at the Massachusetts Institute of Technology in Cambridge, Massachusetts
PTSX	Paul Trap Simulator Experiment at the Princeton Plasma Physics Laboratory
Q	The ratio of the fusion power produced to the power used to heat a plasma
QA	Quality Assurance
QA	Quasi-axisymmetry
QAS	Quasi-axisymmetry Stellarator

QDB	Quiescent Double Barrier
QH-mode	Quiescent High-confinement Mode
R&D	Research and Development
RCS	Reconnection Current Sheet
REs	Reconnection Event(s)
rf	Radio-frequency (Heating)
RFA	Resonant Field Amplification
RGA	Residual Gas Analyzer
RI	Radiative-improved Confinement Mode
RMF ₀	Odd-parity Rotating Magnetic Fields
RSAEs	Reversed-shear Alfvén Eigenmodes
RTAE	Resonant TAE
RWM	Resistive Wall Modes
SAMPLE	Survivable Autonomous Mobile Platform, Long Endurance (Project)
SBIR	Small Business Innovative Research (Program)
SciDAC	(The Department of Energy Office of Science's) Scientific Discovery through Advance Computing Program
SEP	Science Education Program at the Princeton Plasma Physics Laboratory
SF	Shaping field
SGI	Supersonic Gas Injector
SLAC	Stanford Linear Accelerator Center (in California)
SOL	Scrape-off Layer
SSEPN	Steady-state Electric Power Network
SSX	Swarthmore Spheromak Experiment located at the Department of Physics and Astronomy, Swarthmore College, Swarthmore, Pennsylvania
SSX-FRC	Swarthmore Spheromak Experiment-Field-reversed Configuration
ST	Spherical Torus
START	Small Tight Aspect Ratio Tokamak at Culham, United Kingdom
STTR	Small Business Technology Transfer (Program)
SULI	(DOE) Science Undergraduate Laboratory Internship
SXR	Soft X-ray
T	Temperature
TAE	Toroidicity-induced Alfvén Eigenmode or Toroidal Alfvén Eigenmode
TEM	Trapped-electron Mode
TEXTOR	Tokamak Experiment for Technologically Oriented Research in Jülich, Germany
TF	Toroidal Field
TFC	Topical Computing Facility
TFTR	Tokamak Fusion Test Reactor (1982-1997), at the Princeton Plasma Physics Laboratory (no longer operating)
TJ-II	A “flexible” Helic (stellarator) located at the CIEMAT Institute in Madrid, Spain
Tore Supra	Tokamak at Cadarache, France
TRACE	Transition Region and Coronal Explorer (satellite)
TRC	Total Recordable Case
TRC	Twisted Racetrack Coil
TSC	Transport Simulation Code
TWC	Tandem Wing Clapper
UC Davis	University of California at Davis
UCLA	University of California at Los Angeles
UCSD	University of California at San Diego

UKAEA	United Kingdom Atomic Energy Agency
ULF	Ultra-low Frequency
USBPO	U.S. Burning Plasma Organization
USDA	United States Department of Agriculture
USDOE	United States Department of Energy
USIPO	U.S. ITER Project Office (at Oak Ridge National Laboratory)
USXR	Ultra-soft X-ray (tomography)
UV	Ultraviolet
VLAN	Virtual Local Area Networks (at PPPL)
VPN	Virtual Private Network (at PPPL)
VPP	Voluntary Protection Program (An U.S. Department of Energy Program — a reinforcement of Integrated Safety Management which promotes worksite-based safety and health.)
VVSAs	Vacuum Vessel Subassemblies
W7-AS	Wendelstein-7 Advanced Stellarator, an operating stellarator in Germany
W7-X	A stellarator being built in Germany
WPA	Wi-Fi Protected Access
WFOs	Work For Others
WSUS	Windows Server Update Service
WVU	West Virginia University
XP	Experimental Proposal
Y2K	Year 2000

July 2007

Editors: Anthony R. DeMeo and Carol A. Phillips

Contributors: J.W. Anderson, S.A. Cohen, R.C. Davidson, A.R. DeMeo, P.C. Efthimion, N.J. Fisch, S. Gerhardt, E. Gilson, R.J. Goldston, P. Hampton, R.J. Hawryluk, M.T. Iseicz, S.C. Jardin, H. Ji, D.W. Johnson, J.R. Johnson, R. Kaita, J.D. Levine, R.P. Majeski, J. Manickam, L.D. Meixler, G.H. Neilson, M. Ono, M. Peng, C.A. Phillips, R. Raman, B.R. Sobel, B. Stratton, M.D. Williams, P.A. Wieser, J.R. Wilson, M. Yamada, and A.P. Zwicker,

Cover Design: Gregory J. Czechowicz

Photography: Elle Starkman

Graphics: Gregory J. Czechowicz

Layout: Carol A. Phillips

The Princeton Plasma Physics Laboratory is funded by the U.S. Department of Energy under contract DE-AC02-76CH03073 and managed by Princeton University.

This report was prepared as an account of work sponsored by an agency of the United States Government. Neither the United States Government nor any agency thereof, nor any of their employees, nor any of their contractors, subcontractors or their employees, makes any warranty, express or implied, or assumes any legal liability or responsibility for the accuracy, completeness, or any third party's use or the results of such use of any information, apparatus, product, or process disclosed, or represents that its use would not infringe privately owned rights. Reference herein to any specific commercial product, process, or service by trade name, trademark, manufacturer, or otherwise, does not necessarily constitute or imply its endorsement, recommendation, or favoring by the United States Government or any agency thereof or its contractors or subcontractors. The views and opinions of authors expressed herein do not necessarily state or reflect those of the United States Government or any agency thereof.

For additional information contact:

**Information Services
Princeton Plasma Physics Laboratory
P.O. Box 451
Princeton, NJ 08543**

Phone: (609) 243-2750

Fax: (609) 243-2751

e-mail: pppl_info@pppl.gov

Internet Address: <http://www.pppl.gov/>

